



2016 TR-EN
Ürün Katalođu / Fiyat Listesi
Product Catalogue / Price List



İş'in Mutfađı / Kitchen of Business

www.empero.com.tr

İçindekiler
Index



İş'in Mutfağı / Kitchen of Business

7 - 42		Hazırlık Preparation	
43 - 54		Kafeterya Cafe	
55 - 60		Bulaşıkhan Dishwasher	
61 - 74		Piştirme-Snack Serisi Cooking-Snack Series	
75 - 96		700 Serisi 700 Serie	
97 - 118		700+ Serisi 700+ Serie	
119 - 142		900 Serisi 900 Serie	
143 - 164		900+ Serisi 900+ Serie	
165 - 194		Fırınlar Ovens	
195 - 220		Soğutma Ekipmanları Cooling Equipments	
221 - 258		Teşhir Ürünleri Display Product	
259 - 302		Servis Üniteleri Service Units	
303 - 370		Raflar Shelves	
371 - 392		İthal Ürünler Import Products	

Biz Kimiz

1983 yılında Ersöz mutfak makineleri adı altında, sadece hazırlık ekipmanları üreterek, sektöre merhaba diyen şirketimiz, 2005 yılında EMPERO Markasını alarak sektöre hızlı giriş yaptı. Farklı üretim yapan 5 (beş) ayrı şirket kurarak bunları EMPERO GROUP çatısı altında topladı. Endüstriyel mutfak sektöründe paslanmaz çelikten oluşan; hazırlık, kafeterya, bulaşıkhaneye, pişirme, soğutma, ekipmanları, teşhir ürünleri, raflar, gastronom evyeler, askeriye ve sivil toplum örgütleri tarafından kullanılan sahra mutfak ve mobil mutfakların imalatını yaparak rakiplerine fark atmaya başladı.

About Us

EMPERO took its first step into the sector in 1983 with the brand of Ersöz Kitchen Equipments and in 2005 made a fast enter into the sector by uniting its 5 companies, which are producing different needs of Industrial Kitchen Equipments, under the brand of EMPERO GROUP. Empero Group achieved to keep far ahead of its rivals in the market, by manufacturing ; Preparation Equipments, Cafe Equipments, Dishwasher, Cooking Equipments, Cooling Equipments, Display Products, Shelves, Sahra Kitchens and Mobile Kitchens that are used by military and non-governmental organizations in Industrial Kitchen Sector.





Kalite ve Ar-Ge Quality and R&D



Bugün sektörde var oluşunun 33. Yılında tesis kapasitesini 33.000 m² kapalı, 12.000 m²'si açık olmak üzere, toplamda 45.000 m²'ye yükselten Empero, 2.500'e yakın farklı ürünü aynı çatı altında üreterek dünyada başka eşi ve benzeri olmayan modern üretim tesislerindeki, en üst teknolojiye sahip makine parkı ile profesyonel mutfakların çözüm ortağı olduğu gibi; dünya markası olma yolunda hızlı bir şekilde ilerlemekte. 500'ün üzerinde imalat personeli ile üretilen ürünlerini, 50'nin üzerinde idari ve satış personelinin disiplinli çalışmaları ile, yurtiçinde 300 ve yurtdışında 70 ülkede 290'a yakın bayi ve satış noktaları sayesinde ürünlerini pazara sunmaktadır. 125'in üzerinde yetkili servis ağı ile işin mutfağında kusursuz hizmet sunarak Türkiye'de sektöründe lider firma olmuştur.. Her geçen gün daha da büyüyen Empero, ürünlerinin % 52'sini başta Avrupa ülkeleri olmak üzere, 70 ten fazla ülkeye ihraç ederek ülke ekonomisine katkı sağladığı gibi, dünyanın en hızlı büyüyen firmaları arasında yer almayı başarmıştır.

Today, at the 33 th Year of its existence, Empero is extending its area to 45.000 square meter , 33.000 square meter area of which is indoor, and 12.000 square meter outdoor, besides manufacturing 2500 different type of products under the same roof with its high technology machine park at its unique facility on the world, being solution partner of Industrial kitchens and continues moving on the way of by being a World wide known Brand Mark. Empero became the leading company of sector by presenting its products, which are produced by over 400 production staff, to the market with the disciplined efforts of over 50 administrative and Sales staff at its 300 domestic and 290 abroad Sales points in 70 countries. Providing flawless service in the Kitchen of business with its over 120 authorized service and keep growing with each passing day, Empero besides contributing to country economy with its export to 70 countries, 52% of those export goes to the Europe.Empero achieves being one of the fastest growing companies on the world.





Türkiye’ de üretimi olmayan birçok kaliteli ürünü, JP markası adı altında ülkeye ilk defa ithal ederek iç piyasaya sunan EMPERO, kendi ürettiği ürünlerini de dünyanın her yerinde kolay kullanılabilir şekilde tasarlayarak üretiyor. Bu sayede son kullanıcı ve bayilerine maksimum memnuniyet sunuyor.

Yenilikçi çizgisini kaliteden ödün vermeden koruyan EMPERO, işin mutfağında kaliteli ürün ve hizmet sunabilmek için çalışan, üretim yaptığı her alanda liderliği hedefleyen bir firma olmuştur. Piyasada olmayan ürünleri üretmek ve üretimi daha önce yapılmış ürünleri daha kullanışlı hale getirmek adına Ar-Ge çalışmalarına da büyük önem veren Empero, endüstriyel mutfağa yeni bir anlayış getirerek, her alana ve bütçeye uygun etkili çözümler sunuyor. Bu doğrultuda sürekli kendisini geliştiren, araştıran ve çağın ihtiyaçlarına cevap verebilmek adına sürekli yatırım yapan EMPERO, dünya standartlarında yapılan kusursuz üretimler ve satış sonrası verilen hizmetler sayesinde bugün Türkiye’nin en büyüğü olmayı başarmıştır.





Besides succeeding to be focus of interest in Turkey by adding many high quality imported products, that are not produced in Turkey, to its product portfolio with the brand of JP, EMPERO also designs their products to be used easily everywhere in the world. Thus provides maximum contentment to its distributors and users.

EMPERO, keeping its innovative style without compromising from its policy of quality, aims to be the leading company of sector in every field it makes production. To produce products which are not produced before and to improve products which are already in use Empero gives big importance to R&D to serve appropriate solutions to all fields and budgets by bringing new understandings to the sector.

With this understanding ,always continues making research, improving and investing, EMPERO achieves to be the biggest company of Turkey today with flawless production and after sale support. All products that are presented by the signature of EMPERO, reflects the pleasure of quality and comfort to you



Söz konusu mutfakta
kalite ise,varılacak nokta
Empero'dur!

If mentioned topic is quality
in Kitchen, EMPERO is the
point that will be reached!



Hazırlık Ekipmanları
Preparation Equipment



empero@empero.com.tr



Sebze Doğrama Makineleri / Vegetable Cutter
Soğan Doğrama Makineleri / Cutter
Sebze Parçalama Makinesi / Cutter Mixer
Öğütücü / Grinder
Spiral Hamur Yoğurma Makineleri (Çift Devirli) / Spiral Dough Mixers (Double Speed)
Spiral Hamur Yoğurma Makineleri (Tek Devirli) / Spiral Dough Mixer (Mono Speed)
Hamur Yoğurma Makineleri / Dough Kneading Machines
Hamur Yoğurma Makineleri / Dough Kneading Machines
Hamur Açma Makineleri / Dough Roller
Mikserler (Üç Hızlı) / Planetary Mixers (3 Speed)
Mikserler (Hız Kontrollü) / Planetary Mixers (Speed Control)
Et Kıyma Makineleri / Meat Miners
Et Kıyma Makineleri / Meat Miners
Et Kıyma Makineleri / Meat Miners
Soğutmalı Et Kıyma Makineleri / Refrigerated Meat Miners
Plus Et Kıyma Makineleri / Refrigerated Meat Miners
Soğutmalı Plus Et Kıyma Makineleri / Plus Refrigerated Meat Miners
Et ve Kemik Testeresi / Anodized Bone Saw
Patates Soyma Makineleri / Potato Peelers
Tulumba ve Köfte Şekillendirme Makineleri / Semolina Pasta Preparation and Meatball Shapers
Lokma Makineleri / Doughnut Machines
Çatal Kaşık Parlatici / Cutlery Polisher
Bardak Kurutucu / Glass Dryer
Ekmek Dilimleme Makineleri / Bread Slicers
Sıcak Banket Arabaları / Hot Banquet Trolleys
Soğuk Banket Arabaları / Cold Banquet Trolleys
Sıcak - Soğuk Banket Arabası / Hot - Cold Banquet Trolley
Bıçak Sterilizatörü / Knife Sterilizer
Kumpir Fırınları / Potato Baking Ovens
Profesyonel Duvar Tip Izgara / Professional Wall Type Grill
Tabak Kapatma Makinesi / Meal Seal Machine
Streç Makinesi / Stretching Machine
Vakum Makineleri / Vacuum Machines
Piliç Kızartma Makineleri (Elektrikli) / Electrical Chicken Rotisserie
Piliç Kızartma Makineleri (Gazlı) / Gas Chicken Rotisserie

Sebze Doğrama Makineleri Vegetable Cutter



Kod Code	Ürün Adı Description	Ebatlar Dimension mm			Ağırlık Weight kg	Net Net m³	Kapasite Capacity kg/saat-kg/time	Fiyatı Price Euro
		a	b	c				
EMP.300	Sebze Doğrama Makinesi Vegetable Cutter	418	356	501	29	0.07	300	950

Kod Code	Ürün Adı Description	Ebatlar Dimension mm			Ağırlık Weight kg	Net Net m³	Fiyatı Price Euro
		a	b	c			
EMP.300-AS	Sebze Doğrama Makinesi + Alt Stand Vegetable Cutter + Bottom Stand	540	918	850	42	0.17	1.175

Kod Code	Ürün Adı Description	Fiyatı Price Euro
EMP.300 - F.01	Ayarlanabilir Disk / Adjustable Disc	77

Kod Code	Ürün Adı Description	Fiyatı Price Euro
EMP.300 - F.03	5 mm Rende / 5 mm Grater	65

Kod Code	Ürün Adı Description	Fiyatı Price Euro
EMP.300 - F.04	7 mm Rende / 7 mm Grater	65

Kod Code	Ürün Adı Description	Fiyatı Price Euro
EMP.300 - F.06 + F.07	Parmak Patates Bıçağı + Alt Diski French Fries Blade + Disc	95

Kod Code	Ürün Adı Description	Fiyatı Price Euro
EMP.300 - F.11 + F.08	10x10 Kubik Disk + Bıçağı 10x10 Cubic Disc + Blade	95

Kod Code	Ürün Adı Description	Fiyatı Price Euro
EMP.300 - F.12 + F.09	20x20 Kubik Disk + Bıçağı 20x20 Cubic Disc + Blade	95

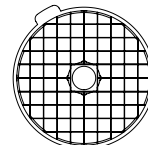
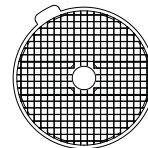
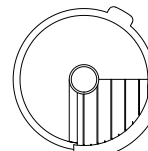
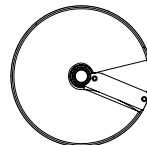
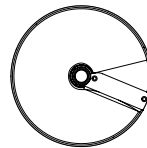
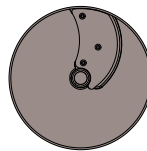
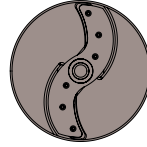

Türkçe

SEBZE DOĞRAMA MAKİNELERİ

EMP.300

- 0.55 Kw 1400 D/Dk-220 V motor gücü.
- Paslanmaz çelik bıçaklar.
- Kolay değiştirilebilir bıçaklar.
- Güvenlik sensörü.
- Paslanmaz çelik gövde.

Standart Bıçaklar

- 1- 1.5-8 mm ayarlanabilir dilimleme bıçağı.
- 2- 4 mm kalınlığında rende.
- 3- 7 mm kalınlığında rende.

English

VEGETABLE CUTTER

EMP.300

- Motor power:0.55 Kw 1400 rpm -220 V
- Stainless steel blades.
- Blades can be easily removed for cleaning.
- Safety switch.
- Stainless steel body.

Standard Blades

- 1- 1.5-8 mm adjustable slicer blade.
- 2- 4 mm thickness grater.
- 3- 7 mm thickness grater.



Su geçirmez touch panel kontrol
Water proof touch panel control

Soğan Doğrama Makineleri Cutter



Kod Code	Ürün Adı Description	Ebatlar Dimension mm			Ağırlık Weight kg	Net Net m ³	Kapasite Capacity lt	Fiyatı Price Euro
		a	b	c				
SD.01Y	Soğan Doğrama Makinesi Cutter	292x490x365			20	0.05	8	525

Türkçe

SOĞAN DOĞRAMA MAKİNELERİ

SD.01Y

- 0,37 Kw 1400 D/Dk-220V motor gücü.
- 240 mm çapında 180 mm derinliğinde paslanmaz çelik kazan.
- Güvenlik sensörü.
- Paslanmaz gövde ve kazan.

English

CUTTER

SD.01Y

- Motor power:0,37 Kw 1400 rpm -220V
- Bowl dimension(diameter/depth): 240 mm/180 mm.
- Safety switch.
- Stainless steel body and bowl.



Kod Code	Ürün Adı Description	Ebatlar Dimension mm			Ağırlık Weight kg	Net Net m ³	Kapasite Capacity lt	Fiyatı Price Euro
		a	b	c				
EMP.350	Soğan Doğrama Makinesi Cutter	333x262x555			19	0.05	8	595

Türkçe

SOĞAN DOĞRAMA MAKİNELERİ

EMP.350

- 0,37 Kw 900 D/Dk-220V motor gücü.
- 240 mm çapında 180 mm derinliğinde paslanmaz çelik kazan.
- Güvenlik sensörü.
- Paslanmaz gövde ve kazan.

English

CUTTER

EMP.350

- Motor power:0,37 Kw 900 rpm -220V
- Bowl dimension(diameter/depth): 240 mm/180 mm.
- Safety switch.
- Stainless steel body and bowl.



**Su geçirmez touch panel kontrol
Water proof touch panel control**

Sebze Parçalama Makinesi Cutter Mixer



Kod Code	Ürün Adı Description	Ebatlar Dimension mm			Ağırlık Weight kg	Net Net m³	Kapasite Capacity lt	Fiyatı Price Euro
		a	b	c				
SD.15	Sebze Parçalama Makinesi Cutter Mixer	380x623x512			46	0.12	15	1.250

Türkçe

SEBZE PARÇALAMA MAKİNESİ

SD.15

- 0.60-0.90 Kw 750 / 1500/Dk motor gücü.
- 380 V çalışma voltajı.
- 290 mm çapında 220 mm derinliğinde paslanmaz çelik kazan.
- Kolay çıkarılabilir bıçak ve kazan.
- Çift devirli zaman ayarlı dijital kontrol panosu.
- Güvenlik sensörü.
- Paslanmaz gövde ve kazan.

English

CUTTER MIXER

SD.15

- Motor power:0.60-0.90 Kw 750 / 1500 rpm.
- 380 V operating voltage.
- Bowl dimension(diameter/depth): 290 mm/220 mm.
- Easy removable blade and bowl.
- Double circuit timer and digital control panel.
- Safety switch.
- Stainless steel body and bowl.



Kod Code	Ürün Adı Description	Ebatlar Dimension mm			Ağırlık Weight kg	Net Net m³	Kapasite Capacity lt	Fiyatı Price Euro
		a	b	c				
SD.07	Sebze Parçalama Makinesi Cutter Mixer	605x610x1010			60	0.37	20	1.750

Türkçe

SEBZE PARÇALAMA MAKİNESİ

SD.07

- 1/1.7 Kw 750 / 1500 D/Dk-380 V motor gücü.
- Kolay çıkarılabilir bıçak ve kazan.
- Çift devirli zaman ayarlı dijital kontrol panosu.
- Güvenlik sensörü.
- Paslanmaz gövde ve kazan.

English

CUTTER MIXER

SD.07

- Motor power:1/1.7 Kw 750 / 1500 rpm -380 V
- Easy removable blade and bowl.
- Double circuit timer and digital control panel.
- Safety switch.
- Stainless steel body and bowl.



Kod Code	Ürün Adı Description	Ebatlar Dimension mm			Ağırlık Weight kg	Net Net m³	Kapasite Capacity lt	Fiyatı Price Euro
		a	b	c				
SD.09	Sebze Parçalama Makinesi Cutter Mixer	640x680x1110			70	0.48	50	2.100

Türkçe

SEBZE PARÇALAMA MAKİNESİ

SD.09

- 2.4/3 Kw 750 / 1500 D/Dk-380 V motor gücü.
- Kolay çıkarılabilir bıçak ve kazan.
- Çift devirli zaman ayarlı dijital kontrol panosu.
- Güvenlik sensörü.
- Paslanmaz gövde ve kazan.

English

CUTTER MIXER

SD.09

- Motor power: 2.4/3 Kw 750 / 1500 rpm -380 V
- Easy removable blade and bowl.
- Double circuit timer and digital control panel.
- Safety switch.
- Stainless steel body and bowl.



Su geçirmez touch panel kontrol
Water proof touch panel control





Kod Code	Ürün Adı Description	Ebatlar Dimension mm			Ağırlık Weight kg	Net Net m ³	Kapasite Capacity gr/sefer-gr/run	Fiyatı Price Euro
		a	b	c				
SD.06	Öğütücü Grinder	399x285x410			18	0.05	800	375

Türkçe

ÖĞÜTÜCÜ

SD.06

- 300-500 W- 9000 D/Dk-220V motor gücü.
- 240 mm çapında 110 mm derinliğinde paslanmaz çelik kazan.
- Güvenlik sensörü.
- Paslanmaz gövde ve kazan.

English

GRINDER

SD.06

- Motor power:300-500 W-9000 rpm -220V
- Bowl dimension(diameter/depth): 240 mm/110 mm.
- Safety switch.
- Stainless steel body and bowl

Spiral Hamur Yoğurma Makineleri (Çift Devirli) Spiral Dough Mixers (Double Speed)



Kod Code	Ürün Adı Description	Ebatlar Dimension mm			Ağırlık Weight kg	Net Net m³	Kazan Ebatları Bowl Size mm	Un Kap. Flour Cap. kg	Kapasite Capacity lt	Fiyatı Price Euro
		a	b	c						
SH.01	Spiral Hamur Yoğurma Mak 30 kg Spiral Dough Mixer 30 kg	440x790x958			179	0.33	400x260	12	30	2.300
SH.02	Spiral Hamur Yoğurma Mak 50 kg Spiral Dough Mixer 50 kg	545x924x1052			212	0.53	500x300	20	50	2.700
SH.03	Spiral Hamur Yoğurma Mak 60 kg Spiral Dough Mixer 60 kg	620x1040x1100			245	0.71	600x315	35	60	3.200

Türkçe

SPİRAL HAMUR YOĞURMA MAKİNELERİ (ÇİFT DEVİRLİ)

SH.01

- 1.0 - 1.7 Kw 750 / 1500 D / Dk. 380 V motor gücü.
- İki hızlı çalışabilen hamur karıştırma kolu.
- 400 mm çapında 260 mm derinliğinde paslanmaz çelik kazan.
- Çift devirli zaman ayarlı dijital kontrol panosu.
- Acil stop
- Paslanmaz çelik hamur karıştırma kolu ve kazan.

SH.02

- 1.5 - 2.5 Kw 750 / 1500 D / Dk. 380 V motor gücü.
- İki hızlı çalışabilen hamur karıştırma kolu.
- 500 mm çapında 300 mm derinliğinde paslanmaz çelik kazan.
- Çift devirli zaman ayarlı dijital kontrol panosu.
- Acil stop.
- Paslanmaz çelik hamur karıştırma kolu ve kazan.

SH.03

- 1.5 - 2.5 Kw 750 / 1500 D / Dk. 380 V motor gücü.
- İki hızlı çalışabilen hamur karıştırma kolu.
- 600 mm çapında 315 mm derinliğinde paslanmaz çelik kazan.
- Çift devirli zaman ayarlı dijital kontrol panosu.
- Acil stop.
- Paslanmaz çelik hamur karıştırma kolu ve kazan.

English

SPIRAL DOUGH MIXER KNEADER (DOUBLE SPEED)

SH.01

- Motor power: 1.0 - 1.7 Kw - 750 / 1500 rpm 380 V
- Two speed dough mixer arm.
- Bowl dimension (diameter / depth): 400 mm / 260 mm
- Equipped with double circuit timer and digital control panel.
- Emergency stop.
- Stainless steel bowl and dough mixer arm.

SH.02

- Motor power: 1.5 - 2.5 Kw - 750 / 1500 rpm 380 V
- Two speed dough mixer arm.
- Bowl dimension (diameter / depth): 500 mm / 300 mm
- Equipped with double circuit timer and digital control panel.
- Emergency stop.
- Stainless steel bowl and dough mixer arm.

SH.03

- Motor power: 1.5 - 2.5 Kw - 750 / 1500 rpm 380 V
- Two speed dough mixer arm.
- Bowl dimension (diameter / depth): 600 mm / 315 mm
- Equipped with double circuit timer and digital control panel.
- Emergency stop.
- Stainless steel bowl and dough mixer arm.



Su geçirmez touch panel kontrol
Water proof touch panel control



Spiral Hamur Yoğurma Makineleri (Tek Devirli)

Spiral Dough Mixer (Mono Speed)



Kod Code	Ürün Adı Description	Ebatlar Dimension mm			Ağırlık Weight kg	Net Net m³	Kazan Ebatları Bowl Size mm	Un Kap. Flour Cap. kg	Kapasite Capacity lt	Fiyatı Price Euro
		a	b	c						
SH.04	Spiral Hamur Yoğurma Makinesi 15 kg Spiral Dough Mixer, 15 kg	385	756	907	100	0.31	360x210	7	15	1.550
SH.05	Spiral Hamur Yoğurma Makinesi 30 kg Spiral Dough Mixer, 30 kg	440	785	958	125	0.53	400x260	12	30	1.900
SH.06	Spiral Hamur Yoğurma Makinesi 50 kg Spiral Dough Mixer, 50 kg	543	924	1052	150	0.73	500x300	20	50	2.150

Türkçe

SPIRAL HAMUR YOĞURMA MAKİNELERİ (TEK DEVİRLİ)

SH.04

- 1.1 Kw 900 D/Dk 380 V motor gücü.
- 360 mm çapında 210 mm derinliğinde paslanmaz çelik kazan.
- Manuel zaman ayarı.
- Acil stop.
- Paslanmaz çelik hamur karıştırma kolu ve kazan.

SH.05

- 1.5 Kw 900 D/Dk 380 V motor gücü.
- 400 mm çapında 260 mm derinliğinde paslanmaz çelik kazan.
- Manuel zaman ayarı.
- Acil stop.
- Paslanmaz çelik hamur karıştırma kolu ve kazan.

SH.06

- 1.5 Kw 900 D/Dk 380 V motor gücü.
- 500 mm çapında 300 mm derinliğinde paslanmaz çelik kazan.
- Manuel zaman ayarı.
- Acil stop.
- Paslanmaz çelik hamur karıştırma kolu ve kazan.

English

SPIRAL DOUGH MIXER KNEADER (MONO SPEED)

SH.04

- Motor power:1.1 Kw 900 rpm 380 V
- Bowl dimension(diameter/depth): 360 mm/210 mm.
- Equipped with Timer
- Emergency stop.
- Stainless steel bowl and dough mixer arm

SH.05

- Motor power:1.1 Kw 900 rpm 380 V
- Bowl dimension(diameter/depth): 400 mm/260 mm.
- Equipped with Timer
- Emergency stop.
- Stainless steel bowl and dough mixer arm

SH.06

- Motor power:1.5 Kw 900 rpm 380 V
- Bowl dimension(diameter/depth): 500 mm/300 mm.
- Equipped with Timer
- Emergency stop.
- Stainless steel bowl and dough mixer arm.



Pizza hamuru yoğurmak için kullanılır.Sert hamurların yoğurulması için kullanılmaz.

Operates in purpose of kneading pizza dough.

Hamur Yoğurma Makineleri Dough Kneading Machines



Kod Code	Ürün Adı Description	Ebatlar Dimension mm			Ağırlık Weight kg	Net Net m³	Kazan Ebatları Bowl Size mm	Un Kap. Flour Cap. kg	Kapasite Capacity lt	Fiyatı Price Euro
		a	b	c						
HY.11	Hamur Yoğurma Makinesi 15kg (220 V) Dough Kneading Machine 15kg (220 V)	440x688x648			51	0.19	360x190	7	15	730
HY.12	Hamur Yoğurma Makinesi 15kg (380 V) Dough Kneading Machine 15kg (380 V)	440x688x648			51	0.19	360x190	7	15	670
HY.01	Hamur Yoğurma Makinesi 30kg (220 V) Dough Kneading Machine 30kg (220 V)	518x858x771			75	0.34	430x225	12	30	945
HY.02	Hamur Yoğurma Makinesi 30kg (380 V) Dough Kneading Machine 30kg (380 V)	518x858x771			75	0.34	430x225	12	30	845
HY.03	Hamur Yoğurma Makinesi 40kg (220 V) Dough Kneading Machine 40kg (220 V)	593x908x772			77	0.41	500x270	20	40	1.000
HY.04	Hamur Yoğurma Makinesi 40kg (380 V) Dough Kneading Machine 40kg (380 V)	593x908x772			77	0.41	500x270	20	40	925
HY.05	Hamur Yoğurma Makinesi 50kg (220 V) Dough Kneading Machine 50kg (220 V)	668x963x791			93	0.50	600x290	30	50	1.100
HY.06	Hamur Yoğurma Makinesi 50kg (380 V) Dough Kneading Machine 50kg (380 V)	668x963x791			93	0.50	600x290	30	50	1.000
HY.07	Hamur Yoğurma Makinesi 75kg (220 V) Dough Kneading Machine 75kg (220 V)	791x1115x882			115	0.77	750x350	50	75	1.395
HY.08	Hamur Yoğurma Makinesi 75kg (380 V) Dough Kneading Machine 75kg (380 V)	791x1115x882			115	0.77	750x350	50	75	1.300

Türkçe

HAMUR YOĞURMA MAKİNELERİ

HY.11-12

- 0.37 Kw 1400 D/Dk 220 V- 380 V motor gücü.
- 360 mm çapında 190 mm derinliğinde paslanmaz çelik kazan.
- Paslanmaz çelik hamur karıştırma kolu ve kazan.

HY.01-02

- 0.55 Kw 1400 D/Dk 220 V- 380 V motor gücü.
- 430 mm çapında 225 mm derinliğinde paslanmaz çelik kazan.
- Paslanmaz çelik hamur karıştırma kolu ve kazan.

HY.03-04

- 0.55 Kw 1400 D/Dk 220 V- 380 V motor gücü.
- 500 mm çapında 270 mm derinliğinde paslanmaz çelik kazan.
- Paslanmaz çelik hamur karıştırma kolu ve kazan.

HY.05-HY.06

- 0.75 Kw 1400 D/Dk 220 V- 380 V motor gücü.
- 600 mm çapında 290 mm derinliğinde paslanmaz çelik kazan.
- Paslanmaz çelik hamur karıştırma kolu ve kazan.

HY.07-HY.08

- 1.10 Kw 1400 D/Dk 220 V- 380 V motor gücü.
- 750 mm çapında 350 mm derinliğinde paslanmaz çelik kazan.
- Paslanmaz çelik hamur karıştırma kolu ve kazan.

English

DOUGH KNEADING MACHINE

HY.11-12

- Motor Power:0.37 Kw 1400 rpm / 220 V-380 V
- Bowl dimension(diameter/depth): 360 mm/190 mm.
- Stainless steel bowl and dough mixer arm.

HY.01-02

- Motor Power: 0.55 Kw 1400 rpm / 220 V-380 V
- Bowl dimension(diameter/depth): 430 mm/225 mm.
- Stainless steel bowl and dough mixer arm.

HY.03-04

- Motor Power:0.55 Kw 1400 rpm / 220 V-380 V
- Bowl dimension(diameter/depth): 500 mm/270 mm.
- Stainless steel bowl and dough mixer arm.

HY.05-HY.06

- Motor Power:0.75 Kw 1400 rpm / 220 V-380 V
- Bowl dimension(diameter/depth): 600 mm/290 mm
- Stainless steel bowl and dough mixer arm.

HY.07-HY.08

- Motor Power:1.10 Kw 1400 rpm / 220 V-380 V
- Bowl dimension(diameter/depth): 750 mm/350 mm
- Stainless steel bowl and dough mixer arm.

Hamur Yoğurma Makineleri Dough Kneading Machines



Kod Code	Ürün Adı Description	Ebatlar Dimension mm			Ağırlık Weight kg	Net Net m³	Kazan Ebatları Bowl Size mm	Un Kap. Flour Cap. kg	Kapasite Capacity lt	Fiyatı Price Euro
		a	b	c						
HY.11.K	Hamur Yoğurma Makinesi 15kg (220 V) Dough Kneading Machine 15kg (220 V)	440	688	648	55	0.19	360x190	7	15	955
HY.12.K	Hamur Yoğurma Makinesi 15kg (380 V) Dough Kneading Machine 15kg (380 V)	440	688	648	55	0.19	360x190	7	15	890
HY.01.K	Hamur Yoğurma Makinesi 30kg (220 V) Dough Kneading Machine 30kg (220 V)	518	858	771	80	0.34	430x225	12	30	1.215
HY.02.K	Hamur Yoğurma Makinesi 30kg (380 V) Dough Kneading Machine 30kg (380 V)	518	858	771	80	0.34	430x225	12	30	1.100
HY.03.K	Hamur Yoğurma Makinesi 40kg (220 V) Dough Kneading Machine 40kg (220 V)	593	908	772	83	0.41	500x270	20	40	1.345
HY.04.K	Hamur Yoğurma Makinesi 40kg (380 V) Dough Kneading Machine 40kg (380 V)	593	908	772	83	0.41	500x270	20	40	1.275
HY.05.K	Hamur Yoğurma Makinesi 50kg (220 V) Dough Kneading Machine 50kg (220 V)	668	963	791	97	0.50	600x290	30	50	1.425
HY.06.K	Hamur Yoğurma Makinesi 50kg (380 V) Dough Kneading Machine 50kg (380 V)	668	963	791	97	0.50	600x290	30	50	1.325
HY.07.K	Hamur Yoğurma Makinesi 75kg (220 V) Dough Kneading Machine 75kg (220 V)	791	1115	882	121	0.77	750x350	50	75	1.755
HY.08.K	Hamur Yoğurma Makinesi 75kg (380 V) Dough Kneading Machine 75kg (380 V)	791	1115	882	121	0.77	750x350	50	75	1.655

Türkçe

HAMUR YOĞURMA MAKİNELERİ

HY.11.K-12.K

- 0.37 Kw 1400 D/Dk 220 V- 380 V motor gücü.
- 360 mm çapında 190 mm derinliğinde paslanmaz çelik kazan.
- Acil stop.
- Paslanmaz çelik hamur karıştırma kolu ve kazan.

HY.01.K-02.K

- 0.55 Kw 1400 D/Dk 220 V- 380 V motor gücü.
- 430 mm çapında 225 mm derinliğinde paslanmaz çelik kazan.
- Acil stop.
- Paslanmaz çelik hamur karıştırma kolu ve kazan.

HY.03.K-04.K

- 0.55 Kw 1400 D/Dk 220 V- 380 V motor gücü.
- 500 mm çapında 270 mm derinliğinde paslanmaz çelik kazan.
- Acil stop.
- Paslanmaz çelik hamur karıştırma kolu ve kazan

HY.05.K-HY.06.K

- 0.75 Kw 1400 D/Dk 220 V- 380 V motor gücü.
- 600 mm çapında 290 mm derinliğinde paslanmaz çelik kazan.
- Acil stop.
- Paslanmaz çelik hamur karıştırma kolu ve kazan.

HY.07.K-HY.08.K

- 1.10 Kw 1400 D/Dk 220 V- 380 V motor gücü.
- 750 mm çapında 350 mm derinliğinde paslanmaz çelik kazan.
- Acil stop.
- Paslanmaz çelik hamur karıştırma kolu ve kazan.

English

DOUGH KNEADING MACHINE

HY.11.K-12.K

- Motor Power:0.37 Kw 1400 rpm / 220 V-380 V
- Bowl dimension(diameter/depth): 360 mm/190 mm.
- Emergency stop.
- Stainless steel bowl and dough mixer arm.

HY.01.K-02.K

- Motor Power: 0.55 Kw 1400 rpm / 220 V-380 V
- Bowl dimension(diameter/depth): 430 mm/225 mm.
- Emergency stop.
- Stainless steel bowl and dough mixer arm.

HY.03.K-04.K

- Motor Power:0.55 Kw 1400 rpm / 220 V-380 V
- Bowl dimension(diameter/depth): 500 mm/270 mm.
- Emergency stop.
- Stainless steel bowl and dough mixer arm.

HY.05.K-HY.06.K

- Motor Power:0.75 Kw 1400 rpm / 220 V-380 V
- Bowl dimension(diameter/depth): 600 mm/290 mm
- Emergency stop.
- Stainless steel bowl and dough mixer arm.

HY.07.K-HY.08.K

- Motor Power:1.10 Kw 1400 rpm / 220 V-380 V
- Bowl dimension(diameter/depth): 750 mm/350 mm
- Emergency stop.
- Stainless steel bowl and dough mixer arm.

Hamur Açma Makineleri Dough Roller



Kod Code	Ürün Adı Description	Ebatlar Dimension mm			Ağırlık Weight kg	Net Net m³	Merdane Ölçüleri Roller Dimensions mm	Fiyatı Price Euro
		a	b	c				
EMP.HA.01	Hamur Açma Makinesi 40 cm Dough Roller 40 cm	530	550	650	41	0.17	400	1.000
EMP.HA.02	Hamur Açma Makinesi 30 cm Dough Roller 30 cm	430	550	650	37	0.14	300	900



Türkçe

HAMUR AÇMA MAKİNELERİ

EMP.HA.01-EMP.HA.02

- 0.25 Kw- 1400 D/Dk-220V motor gücü.
- Ayarlanabilir hamur kalınlığı.
- Pleksiglas koruma kapağı.
- Derlin Merdane.
- Acil stop.
- Paslanmaz çelik gövde.

English

DOUGH ROLLER

EMP.HA.01-EMP.HA.02

- Motor power:0.25 Kw- 1400 rpm-220V
- Adjustable dough thickness.
- Plexiglass protection cover.
- Derlin Roller.
- Emergency stop.
- Stainless steel body.

Kod Code	Ürün Adı Description	Ebatlar Dimension mm			Ağırlık Weight kg	Net Net m³	Merdane Ölçüleri Roller Dimensions mm	Fiyatı Price Euro
		a	b	c				
EMP.HA.01.Y	Hamur Açma Makinesi 40 cm Dough Roller 40 cm	530	550	650	41	0.17	400	1.000
EMP.HA.02.Y	Hamur Açma Makinesi 30 cm Dough Roller 30 cm	430	550	650	37	0.14	300	900



Türkçe

HAMUR AÇMA MAKİNELERİ

EMP.HA.01.Y-EMP.HA.02.Y

- 0.25 Kw- 1400 D/Dk-220V motor gücü.
- Ayarlanabilir hamur kalınlığı.
- Pleksiglas koruma kapağı.
- Derlin Merdane.
- Acil stop.
- Paslanmaz çelik gövde.

English

DOUGH ROLLER

EMP.HA.01.Y-EMP.HA.02.Y

- Motor power:0.25 Kw- 1400 rpm-220V
- Adjustable dough thickness.
- Plexiglass protection cover.
- Derlin Roller.
- Emergency stop.
- Stainless steel body.

Kod Code	Ürün Adı Description	Ebatlar Dimension mm			Ağırlık Weight kg	Net Net m³	Merdane Ölçüleri Roller Dimensions mm	Fiyatı Price Euro
		a	b	c				
EMP.HA.03	Hamur Açma Makinesi 55 cm Dough Roller 55 cm	910	575	535	63	0.28	550	1.750



Türkçe

HAMUR AÇMA MAKİNELERİ

EMP.HA.03

- 0.75 Kw- 1500 D/Dk-220V motor gücü.
- Ayarlanabilir hamur kalınlığı.
- Derlin Merdane.
- Acil stop.
- Paslanmaz çelik gövde.

English

DOUGH ROLLER

EMP.HA.03

- Motor power:0.75 Kw- 1500 rpm-220V
- Adjustable dough thickness.
- Derlin Roller.
- Emergency stop.
- Stainless steel body.



Su geçirmez touch panel kontrol
Water proof touch panel control

Mikserler (Üç Hızlı)
Planetary Mixers (3 Speed)



Kod Code	Ürün Adı Description	Ebatlar Dimension mm			Ağırlık Weight kg	Net Net m ³	Kazan Ebatları Bowl Size mm	Kapasite Capacity lt	Fiyatı Price Euro
		a	b	c					
MK.08	Mikserler (Üç Hızlı) Planetary Mixers (3 Speed)	688	841	1270	184	0.73	360x360	30	2.500
MK.04	Mikserler (Üç Hızlı) Planetary Mixers (3 Speed)	690	888	1366	200	0.84	400x390	40	2.800
MK.06	Mikserler (Üç Hızlı) Planetary Mixers (3 Speed)	690	903	1419	205	0.88	430x445	60	3.000



Çırpma Teli
Whisk



Hamur Baltası
Dough Hook



Çırpma Paleti
Mixing Paddle

Türkçe

MİKSERLER (ÜÇ HIZLI)

MK.04-MK.06

- 1.1-1.5-1.85 Kw 950-1450-2850 D/Dk 380 V motor gücü.
- İki hızlı çalıştırma özelliği.
- 2 adet çırpma teli.
- 1 adet hamur baltası.
- 1 adet çırpma paleti.
- Çift devirli zaman ayarlı dijital kontrol panosu.
- Güvenlik sensörü.
- Paslanmaz çelik kazan.

MK.08

- 1.1-1.5-1.85 Kw 950-1450-2850 D/Dk 380 V motor gücü.
- İki hızlı çalıştırma özelliği.
- 2 adet çırpma teli.
- 1 adet hamur baltası.
- 1 adet çırpma paleti.
- Çift devirli zaman ayarlı dijital kontrol panosu.
- Güvenlik sensörü.
- Paslanmaz çelik kazan.

English

PLANETARY MIXERS (3 SPEED)

MK.04-MK.06

- Motor power:1.1-1.5-1.85 Kw 950-1450-2850 rpm 380 V
- Two-speed operating option.
- 2 of whisks.
- 1 of dough hook.
- 1 of mixing paddle
- Double circuit timer and digital control panel.
- Safety switch.
- Stainless steel bowl

MK.08

- Motor power:1.1-1.5-1.85 Kw 950-1450-2850 rpm 380 V
- Two-speed operating option.
- 2 of whisks.
- 1 of dough hook.
- 1 of mixing paddle
- Double circuit timer and digital control panel.
- Safety switch.
- Stainless steel bowl.

Kontrol Paneli
Control Panel



Su geçirmez touch panel kontrol
Water proof touch panel control



Mikserler (Hız Kontrollü) Planetary Mixers (Speed Control)



Kod Code	Ürün Adı Description	Ebatlar Dimension mm			Ağırlık Weight kg	Net Net m³	Kazan Ebatları Bowl Size mm	Kapasite Capacity lt	Fiyatı Price Euro
		a	b	c					
EMP.10	Hız Kontrollü Mikser Speed Controlled Mixer	450	535	710	55	0.17	260x260	10	1.500

Setüstü / Countertop

Türkçe

MİKSER (HIZ KONTROLLÜ)

EMP.10

- 0,55 Kw 1400 D/Dk-220 V motor gücü.
- Hız kontrollü çalıştırma özelliği.
- 260 mm çapında 260 mm derinliğinde paslanmaz çelik kazan.
- 1 adet çırpma teli.
- 1 adet hamur baltası.
- 1 adet çırpma paleti.
- Hız kontrollü zaman ayarlı dijital kontrol panosu.
- Güvenlik sensörü.

English

MIXER (SPEED CONTROL)

EMP.10

- Motor Power: 0.55 Kw 1400 rpm 220 V
- Speed control
- S.Steel Bowl dimension(diameter/depth): 260 mm/260 mm
- 1 of whisk
- 1 of dough hook
- 1 of mixing paddle
- Equipped with speed controlled timer and digital control panel.
- Safety switch.



Kod Code	Ürün Adı Description	Ebatlar Dimension mm			Ağırlık Weight kg	Net Net m³	Kazan Ebatları Bowl Size mm	Kapasite Capacity lt	Fiyatı Price Euro
		a	b	c					
MK.07	Mikser Planetary Mixer	688	841	1270	184	0.73	360x360	30	2.850
MK.03	Mikser Planetary Mixer	690	888	1366	200	0.84	400x390	40	3.100
MK.05	Mikser Planetary Mixer	690	903	1419	205	0.88	430x445	60	3.300

Türkçe

MİKSER (HIZ KONTROLLÜ)

MK.03-MK.05

- 2.2 Kw 1400 D/Dk 220 V motor gücü.
- Hız kontrollü çalıştırma özelliği.
- 220 V çalışma voltajı.
- 2 adet çırpma teli.
- 1 adet hamur baltası.
- 1 adet çırpma paleti.
- Hız kontrollü zaman ayarlı dijital kontrol panosu.
- Güvenlik sensörü.
- Paslanmaz çelik kazan.

English

MIXER (SPEED CONTROL)

MK.03-MK.05

- Motor power:2.2 Kw 1400 rpm 220 V
- Speed controlled operating option.
- 220 V operating voltage.
- 2 of whisks.
- 1 of dough hook.
- 1 of mixing paddle
- Speed controlled timer and digital control panel.
- Safety switch.
- Stainless steel bowl.



Kontrol Paneli
Control Panel

MK.07

- 1.5 Kw 1400 D/Dk 220 V motor gücü.
- Hız kontrollü çalıştırma özelliği.
- 220 V çalışma voltajı.
- 2 adet çırpma teli.
- 1 adet hamur baltası.
- 1 adet çırpma paleti.
- Hız kontrollü zaman ayarlı dijital kontrol panosu.
- Güvenlik sensörü.
- Paslanmaz çelik kazan.

MK.07

- Motor power:1.5 Kw 1400 rpm 220 V
- Speed controlled operating option.
- 220 V operating voltage.
- 2 of whisks.
- 1 of dough hook.
- 1 of mixing paddle
- Speed controlled timer and digital control panel.
- Safety switch.
- Stainless steel bowl.



Çırpma Teli
Whisk



Hamur Baltası
Dough Hook



Çırpma Paleti
Mixing Paddle

Su geçirmez touch panel kontrol
Water proof touch panel control

Et Kıyma Makineleri
Meat Miners

Paslanmaz çelik kovan helezon, somun grubu
Stainless steel gear housing, spiral, nut group

Kod Code	Ürün Adı Description	Ebatlar Dimension mm			Ağırlık Weight kg	Net Net m³	Kapasite Capacity kg/saat-kg/hour	Fiyatı Price Euro
		a	b	c				
EMP.12.01.P	No:12 Et Kıyma Makinesi (220V) No:12 Meat Mincer (220V)	535x235x370			25	0.04	125	670
EMP.12.02.P	No:12 Et Kıyma Makinesi (380V) No:12 Meat Mincer (380V)	535x235x370			25	0.04	125	610
EMP.22.01.P	No:22 Et Kıyma Makinesi (220V) No:22 Meat Mincer (220V)	555x235x380			29	0.05	200	785
EMP.22.02.P	No:22 Et Kıyma Makinesi (380V) No:22 Meat Mincer (380V)	555x235x380			29	0.05	200	740

Türkçe

ET KIYMA MAKİNELERİ

EMP.12.01.P-EMP.12.02.P

- 0.55 Kw 1400 D/Dk-220 V/380 V motor gücü.
- Paslanmaz çelik helezon, boğaz ve boğaz somunu.
- Kolay sökülebilir et haznesi ile kolay temizlik imkanı.
- El koruma ünitesi ile güvenli çalışma imkanı.
- Paslanmaz çelik gövde.

EMP.22.01.P-EMP.22.02.P

- 0.75 Kw 1400 D/Dk-220 V/380 V motor gücü.
- Paslanmaz çelik helezon, boğaz ve boğaz somunu.
- Kolay sökülebilir et haznesi ile kolay temizlik imkanı.
- El koruma ünitesi ile güvenli çalışma imkanı.
- Paslanmaz çelik gövde.

English

MEAT MINCERS

EMP.12.01.P-EMP.12.02.P

- Motor Power:0.55 Kw 1400 rpm-220 V/380 V
- Stainless steel handwheel and spiral.
- Easy removable handwheel and easy cleaning.
- Hand protection provides safe operation.
- Stainless steel body.

EMP.22.01.P-EMP.22.02.P

- Motor Power: 0.75 Kw 1400 rpm -220 V/380 V
- Stainless steel handwheel and spiral.
- Easy removable handwheel and easy cleaning.
- Hand protection provides safe operation.
- Stainless steel body.

Et Kıyma Makineleri
Meat Mincers



Paslanmaz çelik kovan helezon, somun grubu
Stainless steel gear housing, spiral, nut group

Kod Code	Ürün Adı Description	Ebatlar Dimension mm			Ağırlık Weight kg	Net Net m³	Kapasite Capacity kg/saat-kg/hour	Fiyatı Price Euro
		a	b	c				
EM.01.P	No:32 Et Kıyma Makinesi (220V) No:32 Meat Mincer (220V)	800x360x410			56	0.12	600	1.300
EM.02.P	No:32 Et Kıyma Makinesi (380V) No:32 Meat Mincer (380V)	800x360x410			56	0.12	600	1.215
EM.09.P	No:22 Et Kıyma Makinesi (220V) No:22 Meat Mincer (220V)	770x320x405			51	0.10	400	1.090
EM.10.P	No:22 Et Kıyma Makinesi (380V) No:22 Meat Mincer (380V)	770x320x405			51	0.10	400	1.000



Türkçe

ET KIYMA MAKİNELERİ

EM.01.P-EM.02.P

- 2.2 kw 1400 D/Dk-220 V / 380 V motor gücü.
- Paslanmaz çelik helezon, boğaz ve boğaz somunu.
- Kolay sökülebilir et haznesi ile kolay temizlik imkanı.
- El koruma ünitesi ile güvenli çalışma imkanı.
- Paslanmaz çelik gövde.

EM.09.P-EM.10.P

- 1.5 kw 1400 D/Dk-220 V / 380 V motor gücü.
- Paslanmaz çelik helezon, boğaz ve boğaz somunu.
- Kolay sökülebilir et haznesi ile kolay temizlik imkanı.
- El koruma ünitesi ile güvenli çalışma imkanı.
- Paslanmaz çelik gövde.

English

MEAT MINCERS

EM.01.P-EM.02.P

- Motor Power: 2.2 kw 1400 rpm-220 V / 380 V
- Stainless steel handwheel and spiral.
- Easy removable handwheel and easy cleaning.
- Hand protection provides safe operation.
- Stainless steel body.

EM.09.P-EM.10.P

- Motor Power: 1.5 kw 1400 rpm-220 V / 380 V
- Stainless steel handwheel and spiral.
- Easy removable handwheel and easy cleaning.
- Hand protection provides safe operation.
- Stainless steel body .



Et Kıyma Makineleri
Meat Mincers



Kod Code	Ürün Adı Description	Ebatlar Dimension mm			Ağırlık Weight kg	Net Net m³	Kapasite Capacity kg/saat-kg/hour	Fiyatı Price Euro
		a	b	c				
EM.01	No:32 Et Kıyma Makinesi (220V) No:32 Meat Mincer (220V)	850x360x395			66	0.12	600	1.000
EM.02	No:32 Et Kıyma Makinesi (380V) No:32 Meat Mincer (380V)	850x360x395			66	0.12	600	900
EM.09	No:22 Et Kıyma Makinesi (220V) No:22 Meat Mincer (220V)	790x320x400			52	0.10	400	875
EM.10	No:22 Et Kıyma Makinesi (380V) No:22 Meat Mincer (380V)	790x320x400			52	0.10	400	785

Türkçe

ET KIYMA MAKİNELERİ

EM.01-EM.02

- 2.2 kw 1400 D/Dk-220 V / 380 V motor gücü.
- Kolay sökülebilir et haznesi ile kolay temizlik imkanı.
- El koruma ünitesi ile güvenli çalışma imkanı.
- Paslanmaz çelik gövde.

EM.09-EM.10

- 1.5 kw 1400 D/Dk-220 V / 380 V motor gücü.
- Kolay sökülebilir et haznesi ile kolay temizlik imkanı.
- El koruma ünitesi ile güvenli çalışma imkanı.
- Paslanmaz çelik gövde.

English

MEAT MINCERS

EM.01-EM.02

- Motor Power: 2.2 kw 1400 rpm-220 V / 380 V
- Easy removable handwheel and easy cleaning.
- Hand protection provides safe operation .
- Stainless steel body.

EM.09-EM.10

- Motor Power:1.5 kw 1400 rpm-220 V / 380 V
- Easy removable handwheel and easy cleaning.
- Hand protection provides safe operation.
- Stainless steel body.



Soğutmalı Et Kıyma Makineleri Refrigerated Meat Mincers



**Paslanmaz çelik kovan helezon, somun grubu
Stainless steel gear housing, spiral, nut group**

Kod Code	Ürün Adı Description	Ebatlar Dimension mm			Ağırlık Weight kg	Net Net m³	Kapasite Capacity kg/saat-kg/time	Fiyatı Price Euro
		a	b	c				
EM.07	No:32Soğutmalı Et Kıyma Makinesi (220V) No:32Refrigerated Meat Mincer(220V)	850x361x510			86	0.15	700	1.750
EM.08	No:32 Soğutmalı Et Kıyma Makinesi (380V) No:32 Refrigerated Meat Mincer (380V)	850x361x510			86	0.15	700	1.650

Türkçe

SOĞUTMALI ET KIYMA MAKİNELERİ

EM.07-EM.08

- 2.2 kw 1400 D/Dk-220 V / 380 V motor gücü.
- Paslanmaz çelik helezon, boğaz ve boğaz somunu.
- Et haznesi soğutma özelliği.
- Dijital kontrollü soğutma ünitesi.
- El koruma ünitesi ile güvenli çalışma imkanı.
- Paslanmaz çelik gövde.

English

REFRIGERATED MEAT MINCERS

EM.07-EM.08

- Motor Power: 2.2 kw 1400 rpm-220 V / 380 V
- Stainless steel handwheel and spiral.
- Refrigerated neck.
- Cooling system with digital control.
- Hand protection provides safe operation.
- Stainless steel body.





Plus Et Kıyma Makineleri Plus Meat Mincers



**Paslanmaz çelik kovan helezon, somun grubu
Stainless steel gear housing, spiral, nut group**

Kod Code	Ürün Adı Description	Ebatlar Dimension mm			Ağırlık Weight kg	Net Net m³	Kapasite Capacity kg/saat-kg/hour	Fiyatı Price Euro
		a	b	c				
EM.22.09	No:22 Plus Et Kıyma Makinesi (220V) No:22 Plus Meat Mincer (220V)	505	319	607	50	0.09	400	1.300
EM.22.10	No:22 Plus Et Kıyma Makinesi (380V) No:22 Plus Meat Mincer (380V)	505	319	563	40	0.08	400	1.175
EM.32.09	No:32 Plus Et Kıyma Makinesi (220V) No:32 Plus Meat Mincer (220V)	645	340	620	57	0.13	600	1.655
EM.32.10	No:32 Plus Et Kıyma Makinesi (380V) No:32 Plus Meat Mincer (380V)	645	340	577	47	0.12	600	1.480

Türkçe

PLUS ET KIYMA MAKİNELERİ

- 2.2 kw 1500 D/Dk-220 V / 380 V motor gücü.
- Paslanmaz çelik helezon, boğaz ve boğaz somunu.
- Kolay sökülebilir et haznesi ile kolay temizlik imkanı.
- El koruma ünitesi ile güvenli çalışma imkanı.
- Acil stop.
- Paslanmaz çelik gövde.

English

PLUS MEAT MINCERS

- Motor Power: 2.2 kw 1500 rpm-220 V / 380 V
- Stainless steel handwheel and spiral.
- Easy removable handwheel and easy cleaning.
- Hand protection provides safe operation.
- Emergency stop.
- Stainless steel body.



Soğutmalı Plus Et Kıyma Makineleri Plus Refrigerated Meat Miners



**Paslanmaz çelik kovan helezon, somun grubu
Stainless steel gear housing, spiral, nut group**



Kod Code	Ürün Adı Description	Ebatlar Dimension mm			Ağırlık Weight kg	Net Net m³	Kapasite Capacity kg/saat-kg/time	Fiyatı Price Euro
		a	b	c				
EM.22.09-S	No:22 Soğutmalı Plus Et Kıyma Makinesi (220V) No:22 Plus Refrigerated Meat Mincer(220V)	671	337	602	50	0.12	400	1.655
EM.22.10-S	No:22 Soğutmalı Plus Et Kıyma Makinesi (380V) No:22 Plus Refrigerated Meat Mincer (380V)	671	337	558	40	0.11	400	1.480
EM.32.09-S	No:32 Soğutmalı Plus Et Kıyma Makinesi (220V) No:32 Plus Refrigerated Meat Mincer (220V)	645	340	622	57	0.13	600	1.980
EM.32.10-S	No:32 Soğutmalı Plus Et Kıyma Makinesi (380V) No:32 Plus Refrigerated Meat Mincer (380V)	645	340	578	47	0.12	600	1.785

Türkçe

SOĞUTMALI PLUS ET KIYMA MAKİNELERİ

- 2.2 kw 1500 D/Dk-220 V / 380 V motor gücü.
- Paslanmaz çelik helezon, boğaz ve boğaz somunu.
- Dijital kontrollü soğutma ünitesi.
- El koruma ünitesi ile güvenli çalışma imkanı.
- Acil stop.
- Paslanmaz çelik gövde.

English

PLUS REFRIGERATED MEAT MINCERS

- Motor Power: 2.2 kw 1500 rpm-220 V / 380 V
- Stainless steel handwheel and spiral.
- Cooling system with digital control.
- Hand protection provides safe operation.
- Emergency stop.
- Stainless steel body.



Et ve Kemik Testeresi Anodized Bone Saw



Kod Code	Ürün Adı Description	Ebatlar Dimension mm			Ağırlık Weight kg	Net Net m³	Fiyatı Price Euro
		a	b	c			
EMP.ETK.01	Et ve Kemik Testeresi Anodized Bone Saw	480	545	900	43	0.23	1.400

Türkçe

ET VE KEMİK TESTERESİ

EMP.ETK.01

- 0.75 Kw 900 d / dk 220 V. motor gücü.
- 1800 mm bant uzunluğu.
- 290 mm kesme yüksekliği.
- 195 mm kesme genişliği.
- 380x545 mm çalışma tezgahı
- Acil stop.
- Paslanmaz çelik çalışma yüzeyi ve bıçak.

English

ANODIZED BONE SAW

EMP.ETK.01

- Motor power: 0.75 Kw 900 rpm 220 V.
- Band length: 1800 mm
- Usable cut height: 290 mm
- Usable cut depth: 195 mm
- Working table: 380x545 mm
- Emergency stop.
- Stainless steel working surface and blade.



Kod Code	Ürün Adı Description	Ebatlar Dimension mm			Ağırlık Weight kg	Net Net m³	Fiyatı Price Euro
		a	b	c			
EMP.ETK.02	Et ve Kemik Testeresi - Hazneli Anodized Bone Saw - With Drawer	560	545	1560	81	0.47	1.800

Türkçe

ET VE KEMİK TESTERESİ

EMP.ETK.02

- 1.5 Kw 1400 d / dk 220 V. motor gücü.
- 2100 mm bant uzunluğu.
- 350 mm kesme yüksekliği.
- 230 mm kesme genişliği.
- 465x545 mm çalışma tezgahı
- Acil stop.
- Paslanmaz çelik çalışma yüzeyi ve bıçak.

English

ANODIZED BONE SAW

EMP.ETK.02

- Motor power: 1.5 Kw 1400 rpm 220 V.
- Band length: 2100 mm
- Usable cut height: 350 mm
- Usable cut depth: 230 mm
- Working table: 465x545 mm
- Emergency stop.
- Stainless steel working surface and blade.



Su geçirmez touch panel kontrol
Water proof touch panel control

Patates Soyma Makineleri
Potato Peelers



Kod Code	Ürün Adı Description	Ebatlar Dimension mm			Ağırlık Weight kg	Net Net m³	Kapasite Capacity kg	Fiyatı Price Euro
		a	b	c				
PS.05	Patates Soyma Makinesi (220V) Potato Peeler (220V)	500	700	920	41	0.31	10	1.400
PS.06	Patates Soyma Makinesi (380V) Potato Peeler (380V)	500	700	920	41	0.31	10	1.300
PS.07	Patates Soyma Makinesi (220V) Potato Peeler (220V)	522	800	1068	53	0.47	20	1.750
PS.08	Patates Soyma Makinesi (380V) Potato Peeler (380V)	522	800	1068	53	0.47	20	1.650
PS.09	Patates Soyma Makinesi (220V) Potato Peeler (220V)	552	800	1168	60	0.52	30	2.000
PS.10	Patates Soyma Makinesi (380V) Potato Peeler (380V)	552	800	1168	60	0.52	30	1.900



Kod Code	Ürün Adı Description	Ebatlar Dimension mm			Ağırlık Weight kg	Net Net m³	Kapasite Capacity kg	Fiyatı Price Euro
		a	b	c				
PS.05-F	Filtreli Patates Soyma Makinesi (220V) Filtred Potato Peeler (220V)	500	733	1200	50	0.44	10	1.700
PS.06-F	Filtreli Patates Soyma Makinesi (380V) Filtred Potato Peeler (380V)	500	733	1200	50	0.44	10	1.600
PS.07-F	Filtreli Patates Soyma Makinesi (220V) Filtred Potato Peeler (220V)	520	833	1368	60	0.57	20	2.100
PS.08-F	Filtreli Patates Soyma Makinesi (380V) Filtred Potato Peeler (380V)	520	833	1368	60	0.57	20	2.000
PS.09-F	Filtreli Patates Soyma Makinesi (220V) Filtred Potato Peeler (220V)	552	833	1468	67	0.68	30	2.450
PS.10-F	Filtreli Patates Soyma Makinesi (380V) Filtred Potato Peeler (380V)	552	833	1468	67	0.68	30	2.300



Türkçe

PATATES SOYMA MAKİNELERİ

PS.05-PS.06

- 0.55 kw 900 D/Dk-220 V / 380 V motor gücü.
- 400x380 mm paslanmaz çelik soyma haznesi.
- Zaman ayarlı dijital kontrol panosu.
- Uzun süre kullanılabilen güçlü zımpara.
- 1-2 dk patates soyma süresi.
- Paslanmaz çelik gövde.

PS.07-PS.08

- 0.75 kw 900 D/Dk-220 V / 380 V motor gücü.
- 500x400 mm paslanmaz çelik soyma haznesi.
- Zaman ayarlı dijital kontrol panosu.
- Uzun ömürlü ve güçlü zımpara.
- 1-2 dk patates soyma süresi.
- Paslanmaz çelik gövde.

PS.09-PS.10

- 1.1kw 900 D/Dk-220 V / 380 V motor gücü.
- 500x500 mm paslanmaz çelik soyma haznesi.
- Zaman ayarlı dijital kontrol panosu.
- Uzun ömürlü ve güçlü zımpara.
- 1-2 dk patates soyma süresi.
- Paslanmaz çelik gövde.

English

POTATO PEELERS

PS.05-PS.06

- Motor Power: 0.55 kw 900 rpm-220 V / 380 V
- Stainless steel housing dimension: 400x380 mm
- Equipped with timer and control panel.
- Removable rotating plate and housing covered with durable abrasive.
- Peeling time: 1-2 minute.
- Stainless steel body.

PS.07-PS.08

- Motor Power: 0.75 kw 900 rpm-220 V / 380 V
- Stainless steel housing dimension:500x400 mm
- Equipped with timer and control panel.
- Removable rotating plate and housing covered with durable abrasive.
- Peeling time: 1-2 minute.
- Stainless steel body.

PS.09-PS.10

- Motor Power: 1.1kw 900 rpm-220 V / 380 V
- Stainless steel housing dimension:500x500 mm
- Equipped with timer and control panel.
- Removable rotating plate and housing covered with durable abrasive.
- Peeling time: 1-2 minute.
- Stainless steel body.



Su geçirmez touch panel kontrol
Water proof touch panel control



Hazırlık
Preparation



Tulumba ve Köfte Şekillendirme Makineleri Semolina Pasta Preparation and Meatball Shapers



Kod Code	Ürün Adı Description	Ebatlar Dimension mm			Ağırlık Weight kg	Net Net m³	Kapasite Capacity kg	Fiyatı Price Euro
		a	b	c				
TK.01	Otomatik Tulumba ve Köfte Şekillendirme Makinesi (220V) Automatic Semolina and Meatball Shapers (220V)	470	1530	1030	103	0.76	5	1.200
TK.02	Otomatik Tulumba ve Köfte Şekillendirme Makinesi (380V) Automatic Semolina and Meatball Shapers (380V)	470	1530	1030	103	0.76	5	1.100
TK.05	Otomatik Tulumba ve Köfte Şekillendirme Makinesi (220V) Automatic Semolina and Meatball Shapers (220V)	470	1530	1030	105	0.76	10	1.250
TK.06	Otomatik Tulumba ve Köfte Şekillendirme Makinesi (380V) Automatic Semolina and Meatball Shapers (380V)	470	1530	1030	105	0.76	10	1.200

Türkçe

TULUMBA VE KÖFTE ŞEKİLENDİRME MAKİNELERİ

- 0.37 kw-1400 D/Dk 220 V-380 V motor gücü.
- 6-7 dakika şekillendirme süresi.
- 4 farklı uzunlukta şekil verme imkanı.

English

SEMOLINA PASTA PREPARATION AND MEATBALL SHAPERS

- Motor power:0.37 kw 1400 rpm-220 V / 380 V
- Duration of shaping:6-7 minutes.
- 4 different shaping lenght option.



EMP.LK.001 + EMP.LK.002

Saray ve İzmir Lokma Makinesi
Doughnut Machine

Saray ve İzmir Lokma Makinesi Tezgahı Lpg-Ng
Doughnut Machine Table Lpg-Ng

Lokma Makineleri Doughnut Machines

Kod Code	Ürün Adı Description	Ebatlar Dimension mm	Ağırlık Weight kg	Net Net m³	Fiyatı Price Euro
EMP.LK.001	Saray ve İzmir Lokma Makinesi - 220 V. Doughnut Machine 220 V.	300x500x300	24	0.05	1.200
EMP.LK.002	Saray ve İzmir Lokma Makinesi Tezgahı Lpg-Ng Doughnut Machine Table Lpg-Ng	1600x750x850	75	1.1	1.850
EMP.LK.003	Saray ve İzmir Lokma Makinesi Tezgahı Elektrikli 220 V Doughnut Machine Table Electrical 220 V	1600x750x850	75	1.1	2.000
EMP.LK.004	Saray ve İzmir Lokma Makinesi Standı Doughnut Machine Stand	600x600x550	12	0.20	225

Türkçe

SARAY VE İZMİR LOKMA MAKİNESİ

- 220 V. - 50 Hz Enerji.
- 7 kg hamur hazne kapasitesi.
- 25 lt pişirme kazanı.
- Kilitlenebilir tekerlekler.
- Paslanmaz çelik gövde.

Saray Lokma Makinesi dakikada 300 adet
300 pieces of doughnut per a minute

İzmir Lokma Makinesi dakikada 48 adet
48 pieces of doughnut per a minute

English

DOUGHNUT MACHINES

- 220 V. - 50 Hz Energy.
- Dough capacity: 7 kg
- Cooking bowl capacity: 25 lt
- Lockable castors.
- Stainless steel body.



EMP.LK.001
Saray ve İzmir Lokma Makinesi
Doughnut Machine



EMP.LK.001+EMP.LK.004
Saray ve İzmir Lokma Makinesi
Doughnut Machine
Standı
Doughnut Machine Stand

Çatal Kaşık Parlaticılar Cutlery Polisher



Kod Code	Ürün Adı Description	Ebatlar Dimension mm			Ağırlık Weight kg	Net Net m³	Kapasite Capacity lt	Fiyatı Price Euro
		a	b	c				
EMP.CKP.01	Çatal Kaşık Parlaticı Cutlery Polisher	560	550	410	50	0.12	3000	1.500



Türkçe

ÇATAL KAŞIK PARLATICI

EMP.CKP.01

- 0,60 Kw 220 V Toplam makine gücü.
- 8 W gücünde ultraviyole ampül.
- 3 Kg parlaticı ürün kapasitesi.
- 3000 Adet / Saat parlatma kapasitesi.
- Paslanmaz çelik gövde.

English

CUTLERY POLISHER

EMP.CKP.01

- Total power:0.60 Kw 220 V
- Ultraviolet lamp power : 8 W
- 3 Kg tank capacity for polisher material.
- 3000 Piece/Hour polishing capacity.
- Stainless steel body.

Kod Code	Ürün Adı Description	Ebatlar Dimension mm			Ağırlık Weight kg	Net Net m³	Kapasite Capacity lt	Fiyatı Price Euro
		a	b	c				
EMP.CKP.02	Çatal Kaşık Parlaticı Cutlery Polisher	660	650	700	82	0.3	7000	1.950



Türkçe

ÇATAL KAŞIK PARLATICI

EMP.CKP.02

- 0,80 Kw 220 V Toplam makine gücü.
- 8 W gücünde ultraviyole ampül.
- 5 Kg parlaticı ürün kapasitesi.
- 7000 Adet / Saat parlatma kapasitesi.
- Paslanmaz çelik gövde.

English

CUTLERY POLISHER

EMP.CKP.02

- Total power:0.80 Kw 220 V
- Ultraviolet lamp power : 8 W
- 5 Kg tank capacity for polisher material.
- 7000 Piece/Hour polishing capacity.
- Stainless steel body.



Su geçirmez touch panel kontrol
Water proof touch panel control

Bardak Kurutucu
Glass Dryer

Kod Code	Ürün Adı Description	Ebatlar Dimension mm			Ağırlık Weight kg	Net Net m³	Kapasite Capacity Bardak/Saat Glass/Hour	Fiyatı Price Euro
		a	b	c				
EMP.BPR.001	Bardak Kurutucu Glass Dryer	595x322x510			27	0.1	600-720	1.200

Türkçe
BARDAK KURUTUCU
EMP.BPR.001

- 0,37 Kw 220 V/50-60 Hz motor gücü.
- 2,62 Kw makine toplam gücü.
- 600-720 bardak/saat kapasitesi.
- 8 adet bardak parlatici püskülü.
- Sıcak hava kurutma kanalları.
- Paslanmaz çelik gövde.

English
GLASS DRYER
EMP.BPR.001

- Motor power:0,37 Kw 220 V/50-60 Hz
- 2,62 Kw total power.
- 600/720 glass/hour capacity.
- 8 pieces glass polisher tassels.
- Hot air drying.
- Stainless steel body.



Kod Code	Ürün Adı Description	Ebatlar Dimension mm			Ağırlık Weight kg	Net Net m³	Kapasite Capacity Bardak/Saat Glass/Hour	Fiyatı Price Euro
		a	b	c				
EMP.BPR.002	Bardak Kurutucu Glass Dryer	360x340x510			19,5	0.06	300-360	950

Türkçe
BARDAK KURUTUCU
EMP.BPR.002

- 0,37 Kw 220 V/50-60 Hz motor gücü.
- 1,49 Kw makine toplam gücü.
- 300-360 bardak/saat kapasitesi.
- 5 adet bardak parlatici püskülü.
- Sıcak hava kurutma kanalları.
- Paslanmaz çelik gövde.

English
GLASS DRYER
EMP.BPR.002

- Motor power:0,37 Kw 220 V/50-60 Hz
- 1,49 Kw total power.
- 300-360 glass/hour capacity.
- 5 pieces glass polisher tassels.
- Hot air drying.
- Stainless steel body.

Kod Code	Ürün Adı Description	Fiyatı Price Euro
Y.EMP.BPR.001.1008	Uzun Püskül / Long Tassel	13
Y.EMP.BPR.001.1009	Kısa Püskül / Short Tassel	10

Ekmek Dilimle Makineleri Bread Slicers



Kod Code	Ürün Adı Description	Ebatlar Dimension mm			Ağırlık Weight kg	Net Net m³	Kapasite Capacity Dilim/Saat Slice/Hour	Fiyatı Price Euro
		a	b	c				
EMP.3003	Baget Ekmek Dilimleyici Baget Bread Slicer	400x545x1001			30	0.22	8000	1.100

Türkçe

BAGET EKMEK DİLİMLEYİCİ

EMP.3003

- 0,60 Kw 220 V motor gücü.
- 10-80 mm dilim kalınlığı.
- 8000 dilim/saat kapasitesi.
- Paslanmaz çelik gövde.

English

BAGET BREAD SLICER

EMP.3003

- Motor power:0.60 Kw 220 V
- 10-80 mm slice thickness.
- 8000 slice /hour capacity.
- Stainless steel body.



Kod Code	Ürün Adı Description	Ebatlar Dimension mm			Ağırlık Weight kg	Net Net m³	Fiyatı Price Euro
		a	b	c			
EMP.3001	Ekmek Dilimleme Makinesi Bread Slicer	700x700x1100			132	0.54	1.320
EMP.3002	Trabzon Ekmek Dilimleme Makinesi Bread Slicer	700x800x1100			132	0.62	1.380

Türkçe

EKMEK DİLİMLEME MAKİNESİ

EMP.3001

- 0.37 kw - 220 V motor gücü.
- 500 mm ekmek uzunluğu.
- 140 mm ekmek yüksekliği.
- 16 mm dilim kalınlığı.
- 30 adet bıçak.
- Paslanmaz çelik bıçaklar.

EMP.3002

- 0.37 kw - 220 V motor gücü.
- 500 mm ekmek uzunluğu.
- 170 mm ekmek yüksekliği.
- 20 mm dilim kalınlığı.
- 24 adet bıçak.
- Paslanmaz çelik bıçaklar.

English

BREAD SLICER

EMP.3001

- Motor Power:0.37 kw - 220 V
- Bread lenght: 500 mm
- Bread height: 140 mm
- Slice thickness:16 mm
- Quantity of blades:30
- Stainless steel blades.

EMP.3002

- Motor Power:0.37 kw - 220 V
- Bread lenght: 500 mm
- Bread height: 170 mm
- Slice thickness:20 mm
- Quantity of blades: 24
- Stainless steel blades.



Kod Code	Ürün Adı Description	Ebatlar Dimension mm			Ağırlık Weight kg	Net Net m³	Fiyatı Price Euro
		a	b	c			
EMP.3004	Setüstü Ekmek Dilimleme Makinesi Bench Top Bread Slicer	650x650x700			120	0.30	1.450

Türkçe

EKMEK DİLİMLEME MAKİNESİ

EMP.3004

- 0.37 kw - 220 V motor gücü.
- 480 mm ekmek uzunluğu.
- 130 mm ekmek yüksekliği.
- 13 mm dilim kalınlığı.
- 30 adet bıçak.
- Paslanmaz çelik bıçaklar.

English

BREAD SLICER

EMP.3004

- Motor Power:0.37 kw - 220 V
- Bread lenght: 480 mm
- Bread height: 130 mm
- Slice thickness:13 mm
- Quantity of blades: 30
- Stainless steel blades.



Sıcak Banket Arabaları
Hot Banquet Trolleys

Kod Code	Ürün Adı Description	Ebatlar Dimension mm			Ağırlık Weight kg	Net Net m³	Güç Power kw	Kapasite Capacity	Fiyatı Price Euro
		a	b	c					
EMP.BQ1	Sıcak Banket Arabası Hot Banquet Trolley	717	888	1803	111	1.21	1.7	11xGN2/1	1.600



Kod Code	Ürün Adı Description	Ebatlar Dimension mm			Ağırlık Weight kg	Net Net m³	Güç Power kw	Kapasite Capacity	Fiyatı Price Euro
		a	b	c					
EMP.BQ2	Sıcak Banket Arabası Hot Banquet Trolley	1352	888	1803	200	2.17	3.4	2x(11xGN2/1)	3.100



Kod Code	Ürün Adı Description	Ebatlar Dimension mm			Ağırlık Weight kg	Net Net m³	Güç Power kw	Kapasite Capacity	Fiyatı Price Euro
		a	b	c					
EMP.BQ3	Sıcak Banket Arabası Hot Banquet Trolley	717	888	1245	60	0.79	1.7	6xGN2/1	1.300



Kod Code	Ürün Adı Description	Ebatlar Dimension mm			Ağırlık Weight kg	Net Net m³	Güç Power kw	Kapasite Capacity	Fiyatı Price Euro
		a	b	c					
EMP.BQ4	Sıcak Banket Arabası Hot Banquet Trolley	582	768	1684	85	0.75	1.7	15xGN1/1	1.350

Türkçe
SICAK BANKET ARABALARI

- 0°C - 90°C çalışma ısısı.
- 220 V çalışma voltajı.
- Dijital termostat kontrol ünitesi.
- İç ısı göstergesi.
- Nemlendirme.
- Çıkarılabilir kaset ve kolay temizleme.
- Mıknatıslı kilit.
- Kilitlenebilir tekerlekler ile sabitleyebilme özelliği.
- 40 kg/m3 yoğunluk poliüretan izolasyon.
- Pres baskı iç tepsi kızakları.
- Paslanmaz çelik gövde.

English
HOT BANQUET TROLLEYS

- 0°C - 90°C operating temperature.
- Operating voltage : 220 V
- Digital thermostat control unit.
- Interior heating indicator.
- Humidification system.
- Removable drawer and easy to clean.
- Magnetic locker.
- Lockable castors provide stabilizing.
- Isolation type:40 kg/m3 density polyurathane isolation.
- Pressed interior tray slides.
- Stainless steel body.



Soğuk Banket Arabaları Cold Banquet Trolleys



Kod Code	Ürün Adı Description	Ebatlar Dimension mm			Ağırlık Weight kg	Net Net m³	Güç Power kw	Kapasite Capacity	Fiyatı Price Euro
		a	b	c					
EMP.BQ1-S	Soğuk Banket Arabası Cold Banquet Trolley	720	885	1830	131	1.16	0.35	11xGN2/1	2.150



Kod Code	Ürün Adı Description	Ebatlar Dimension mm			Ağırlık Weight kg	Net Net m³	Güç Power kw	Kapasite Capacity	Fiyatı Price Euro
		a	b	c					
EMP.BQ2-S	Soğuk Banket Arabası Cold Banquet Trolley	1360	885	1830	240	2.20	0.7	2x(11xGN2/1)	4.000



Kod Code	Ürün Adı Description	Ebatlar Dimension mm			Ağırlık Weight kg	Net Net m³	Güç Power kw	Kapasite Capacity	Fiyatı Price Euro
		a	b	c					
EMP.BQ3-S	Soğuk Banket Arabası Cold Banquet Trolley	720	885	1250	80	0.79	0.35	6xGN2/1	1.750



Kod Code	Ürün Adı Description	Ebatlar Dimension mm			Ağırlık Weight kg	Net Net m³	Güç Power kw	Kapasite Capacity	Fiyatı Price Euro
		a	b	c					
EMP.BQ4-S	Soğuk Banket Arabası Cold Banquet Trolley	505	775	1830	105	0.71	0.35	15xGN1/1	1.800



Türkçe

SOĞUK BANKET ARABASI

- Çalışma aralığı; +0 ° C, + 5 ° C (tropikal 43° C)
- 220 V-230 V -1 +N -50 60 Hz elektrik gücü.
- "CFC Free", R-134 A soğutucu gaz.
- 220 V çalışma voltajı.
- Dijital termostat kontrol ünitesi.
- Miknatsız kilit.
- Kilitlenebilir tekerlekler ile sabitleyebilme özelliği.
- 40 kg/m3 yoğunluk poliüretan izolasyon.
- Pres baskı iç tepsi kızakları.
- Paslanmaz çelik gövde.

English

COLD BANQUET TROLLEY

- Working temperature; 0° C, + 5° C (at ambient temp.43° C)
- 220 V-230 V -1 +N -50 60 Hz electrical power.
- "CFC Free", R-134 A refrigerant gas.
- Operating voltage : 220 V
- Digital thermostat control unit.
- Magnetic locker.
- Lockable castors provide stabilizing.
- Isolation type:40 kg/m3 density polyurathane isolation.
- Pressed interior tray slides.
- Stainless steel body.

Sıcak - Soğuk Banket Arabası
Hot - Cold Banquet Trolley



Kod Code	Ürün Adı Description	Ebatlar Dimension mm			Ağırlık Weight kg	Net Net m ³	Güç Power kw	Kapasite Capacity	Fiyatı Price Euro
		a	b	c					
EMP.BQ5	Sıcak - Soğuk Banket Arabası Hot - Cold Banquet Trolley	1352	888	1803	220	2.17	4.1	2x(11xGN2/1)	3.750

Türkçe

SICAK - SOĞUK BANKET ARABALARI

- Bir modül soğuk bir modül sıcak olarak çalışır.
- 220 V çalışma voltajı.
- Dijital termostat kontrol ünitesi.
- İç ısı göstergesi.
- Nemlendirme.
- Çalışma aralığı; +0 ° C, + 5 ° C (tropikal 43° C)
- 220 V-230 V -1 +N -50 60 Hz elektrik gücü.
- "CFC Free", R-134 A soğutucu gaz.
- Dijital termostat kontrol ünitesi.
- Manyetik kilit.
- Kilitlenebilir tekerlekler ile sabitleyebilme özelliği.
- 40 kg/m³ yoğunluk poliüretan izolasyon.
- Pres baskı iç tepsi kızakları.
- Paslanmaz çelik gövde.

English

HOT - COLD BANQUET TROLLEYS

- One modul operates cold one modul operates hot.
- Operating voltage : 220 V
- Digital thermostat control unit.
- Interior heating indicator.
- Humiditication system.
- Working temperature; 0° C, + 5° C (at ambient temp.43° C)
- 220 V-230 V -1 +N -50 60 Hz electrical power.
- "CFC Free", R-134 A refrigerant gas.
- Digital thermostat control unit.
- Magnetic locker.
- Lockable castors provide stabilizing.
- Isolation type:40 kg/m³ density polyurathane isolation.
- Pressed interior tray slides.
- Stainless steel body.

Bıçak Sterilizatörü
Knife Sterilizer



Kod Code	Ürün Adı Description	Ebatlar Dimension mm			Ağırlık Weight kg	Net Net m³	Güç Power W	Kapasite Capacity Adet/Pieces	Fiyatı Price Euro
		a	b	c					
EMP.BST.001	Bıçak Sterilizatörü Knife Sterilizer	552x131x620			9	0.05	0.1	10	170
EMP.BST.002	Bıçak Sterilizatörü Knife Sterilizer	1022x131x620			13	0.09	0.2	20	250



Türkçe

BIÇAK STERİLİZATÖRÜ

- 0-120 dakika zaman ayarı.
- Renkli pleksiglas kapak.
- Paslanmaz çelik gövde.

English

KNIFE STERILIZER

- Timer:0-120 minutes.
- Plexiglass doors.
- Stainless steel body.

Dizden Kumandalı El Yıkama Eyesi
Knee Operating Handwash Basin



Kod Code	Ürün Adı Description	Ebatlar Dimension mm			Ağırlık Weight kg	Net Net m³	Fiyatı Price Euro
		a	b	c			
EMP.DKE.001	Dizden Kumanda El Yıkama Eyesi Knee Operating Handwash Basin	505x450x220			7	0.05	190

Türkçe

**DİZDEN KUMANDALI EL
YIKAMA EVYESİ**

- 15 saniye boyunca su akıtma özelliği.
- Duvara monte edilebilir.
- Paslanmaz çelik gövde.

English

**KNEE OPERATING
HANDWASH BASIN**

- 15 seconds water flow is available in every operation.
- Wall-mounted option.
- Stainless steel body.

Kumpir Fırınları
Potato Baking Ovens

 Gazlı Kumpir Fırını - Üç Çekmeceli
Gas Potato Baking Ovens - Three Drawers

 Elektrikli Kumpir Fırını - Üç Çekmeceli
Electrical Potato Baking Ovens - Three Drawers

Kod Code	Ürün Adı Description	Ebatlar Dimension mm			Ağırlık Weight kg	Net Net m³	Güç Power Kw	Kapasite Capacity Adet/Saat Pieces/Hour	Fiyatı Price Euro
		a	b	c					
EMP.KFE.020	Elektrikli Kumpir Fırını - İki Çekmeceli Electrical Potato Baking Ovens - Two Drawers	500	700	750	45	0.26	3	24-30	1.025
EMP.KFE.030	Elektrikli Kumpir Fırını - Üç Çekmeceli Electrical Potato Baking Ovens - Three Drawers	500	700	980	60	0.34	4.5	36-45	1.145
EMP.KFG.020	Gazlı Kumpir Fırını - İki Çekmeceli Gas Potato Baking Ovens - Two Drawers	500	700	950	55	0.33	4.9	24-30	1.025
EMP.KFG.030	Gazlı Kumpir Fırını - Üç Çekmeceli Gas Potato Baking Ovens - Three Drawers	500	700	1200	73	0.42	4.9	36-45	1.145

Türkçe
ELEKTRİKLİ KUMPIR FIRINI
EMP.KFE.020 - EMP.KFE.030

- EMP.KFE.020 için; 3 Kw 380V - 50 Hz güç.
- EMP.KFE.030 için; 4.5 Kw 380V - 50 Hz güç.
- Her çekmece için ayrı rezistans.
- Çift izolasyonlu gövde.
- Termostat kontrollü.
- Paslanmaz çelik çekmeceler.

GAZLI KUMPIR FIRINI
EMP.KFG.020 - EMP.KFG.030

- LPG ve NG ile çalışabilme özelliği.
- Her çekmece için ayrı brülör.
- Çift izolasyonlu gövde.
- Emniyet ventili ve piezo çakmak ile kontrol.
- Paslanmaz çelik çekmeceler.

English
ELECTRICAL POTATO BAKING OVENS
EMP.KFE.020 - EMP.KFE.030

- EMP.KFE.020 power; 3 Kw 380V - 50 Hz
- EMP.KFE.030 power; 4.5 Kw 380V - 50 Hz
- Separated resistance in each drawer.
- Double insulated body.
- Thermostat controlled.
- Stainless steel drawers.

GAS POTATO BAKING OVENS
EMP.KFG.020 - EMP.KFG.030

- LPG or Naturel gas.
- Separated burner in each drawer.
- Double insulated body.
- Piezoelectric ignition system and safety valve.
- Stainless steel drawers.



Profesyonel Duvar Tip Izgara Professional Wall Type Grill



EMP.PRG.01

Kod Code	Ürün Adı Description	Ebatlar Dimension mm			Ağırlık Weight kg	Net Net m³	Fiyatı Price Euro
		a	b	c			
EMP.PRG.01	Profesyonel Duvar Tipi Izgara Professional Wall Type Grill	1600x750x2350			455	2.82	3.200
EMP.PRG.02	Profesyonel Duvar Tipi Izgara Professional Wall Type Grill	2150x750x2350			600	3.79	4.100

Türkçe

PROFESYONEL DUVAR TİPİ IZGARA

EMP.PRG.01

- 400x500 mm kömür yakma haznesi.
- 2 adet yüksekliği ayarlanabilir 510x530 mm kömür haznesi.
- 20 cm paslanmaz çelik ön çalışma tablası.
- Ön yüzü çift cidarlı monoblok davlumbaz.
- Devrilir kömür saklama haznesi.
- Kül toplama çekmeceleri.
- Yanma işlemini hızlandıran ayarlanabilir hava penceresi.
- Ayarlanabilir havalandırma flapları.
- Dekoratif elektrostatik boyalı gövde.

EMP.PRG.02

- 400x500 mm kömür yakma haznesi.
- 3 adet yüksekliği ayarlanabilir 510x530 mm kömür haznesi.
- 20 cm paslanmaz çelik ön çalışma tablası.
- Ön yüzü çift cidarlı monoblok davlumbaz.
- Devrilir kömür saklama haznesi.
- Kül toplama çekmeceleri.
- Yanma işlemini hızlandıran ayarlanabilir hava penceresi.
- Ayarlanabilir havalandırma flapları.
- Dekoratif elektrostatik boyalı gövde.

English

PROFESSIONAL WALL TYPE GRILL

EMP.PRG.01

- 400x500 mm charcoal reservoir.
- Grill with two adjustable charcoal trays (510x530 mm).
- 20 cm stainless steel front worktop.
- Monoblock hood with double jacket on front surface.
- Tilting drawer for charcoal storage.
- Ash drawer.
- Adjustable air passage provides quick burning.
- Adjustable air circulating flaps.
- Decorative electrostatics dyed body.

EMP.PRG.02

- 400x500 mm charcoal reservoir.
- Grill with three adjustable charcoal trays (510x530 mm).
- 20 cm stainless steel front worktop.
- Monoblock hood with double jacket on front surface.
- Tilting drawer for charcoal storage.
- Ash drawer.
- Adjustable air passage provides quick burning.
- Adjustable air circulating flaps.
- Decorative electrostatics dyed body.



Tabak Kapatma Makinesi Meal Seal Machine



Kod Code	Ürün Adı Description	Ebatlar Dimension mm			Ağırlık Weight kg	Net Net m³	Güç Power Kw	Fiyatı Price Euro
		a	b	c				
EMP.TKM.01	Tabak Kapatma Makinesi Meal Seal Machine	320x650x310			21	0.06	1	1.200
	Standart Dışı Kalıp Fiyat Farkı Custom Made Mold Price Difference							350

Türkçe

TABAK KAPATMA MAKİNESİ

- 230 V. 50 Hz elektrik bağlantısı.
- 270x250 mm mühürleme ebadı.
- 200 mm film kalınlığı.
- Maksimum 245 mm film genişliği.
- Paslanmaz çelik gövde.

English

MEAL SEAL MACHINE

- 230 V. 50 Hz electric connection.
- Seal surface: 270x250 mm
- Roll thickness of the film: 200 mm
- Film width: 245 mm max.
- Stainless steel body.

Standart Kalıp Standard Mold

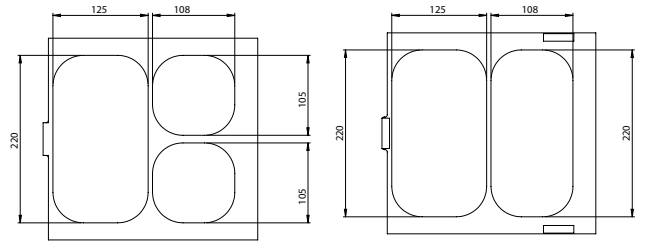

Streç Makinesi Stretching Machine

Kod Code	Ürün Adı Description	Ebatlar Dimension mm			Ağırlık Weight kg	Net Net m³	Güç Power Kw	Fiyatı Price Euro
		a	b	c				
EMP.SCM.01	Streç Makinesi Stretching Machine	550x520x250			7	0.07	0.17	170

Türkçe

STREÇ MAKİNESİ

- 220 V. 50-60 Hz elektrik bağlantısı.
- Filmin yabancı maddelerden korunmasını sağlayan koruma.
- 400 mm film boyu.
- Maksimum 90 °C ısıtıcı plaka sıcaklığı.
- Maksimum 150 °C kesici sıcaklığı.
- Paslanmaz çelik gövde.

English

STRETCHING MACHINE

- 220 V. 50-60 Hz electric connection.
- Top protector in order to provide damage on film.
- 400 mm film length.
- Maximum 90°C heating plate temperature.
- Maximum 150°C cutter temperature.
- Stainless steel body.

Vakum Makineleri Vacuum Machines



Kod Code	Ürün Adı Description	Ebatlar Dimension mm			Ağırlık Weight kg	Net Net m³	Güç Power Kw	Fiyatı Price Euro
		a	b	c				
EMP.VCM.01	Vakum Makinesi Vacuum Machine	496	343	454	36	0.05	0.4	1.650

Türkçe

VAKUM MAKİNELERİ

EMP.VCM.01

- 220 V. 50 Hz elektrik bağlantısı.
- İç Hazne: 280x385x50 mm
- Yapıştırma Ağızı: 250 mm
- 260x8 mm mühürleme ebadı.
- 10 m³/h pompa kapasitesi.
- Şeffaf üst kapak kapasitesi.
- Otomatik kontrol.
- Paslanmaz çelik gövde.

English

VACUUM MACHINES

EMP.VCM.01

- 220 V. 50 Hz electric connection.
- Interior Reservoir: 280x385x50 mm
- Vacuuming Area : 250 mm
- Seal surface: 260x8 mm
- Pump capacity: 10m³/h
- Translucent top cover.
- Automatic control.
- Stainless steel body.



Kod Code	Ürün Adı Description	Ebatlar Dimension mm			Ağırlık Weight kg	Net Net m³	Güç Power Kw	Fiyatı Price Euro
		a	b	c				
EMP.VCM.02	Vakum Makinesi Vacuum Machine	575	735	566	68	0.13	0.9	2.850

Türkçe

VAKUM MAKİNELERİ

EMP.VCM.02

- 220 V. 50 Hz elektrik bağlantısı.
- İç Hazne: 460x450x170 mm
- Yapıştırma Ağızı: 430 mm
- 430x8 mm mühürleme ebadı.
- 20 m³/h pompa kapasitesi.
- Şeffaf üst kapak kapasitesi.
- Otomatik kontrol.
- Paslanmaz çelik gövde.

English

VACUUM MACHINES

EMP.VCM.02

- 220 V. 50 Hz electric connection.
- Interior Reservoir: 460x450x170 mm
- Vacuuming Area : 430 mm
- Seal surface: 430x8 mm.
- Pump capacity: 20 m³/h.
- Translucent top cover.
- Automatic control.
- Stainless steel body.



**Sıvıların vakumlanması mümkün değildir.
Does not operate in purpose of vacuuming liquids.**





Hazırlık
Preparation



Piliç Kızartma Makineleri (Elektrikli) Electrical Chicken Rotisserie



Kod Code	Ürün Adı Description	Ebatlar Dimension mm			Ağırlık Weight kg	Net Net m ³	Güç Power kw	Kapasite Capacity adet-pieces	Fiyatı Price Euro
		a	b	c					
EMP.3EE	Piliç Kızartma Makinesi - Elektrikli Electrical Chicken Rotisserie	1098x480x820			80	0.44	9.9	18	2.765
EMP.5EE	Piliç Kızartma Makinesi - Elektrikli Electrical Chicken Rotisserie	1098x480x1170			104	0.62	16.5	30	3.600
EMP.8EE	Piliç Kızartma Makinesi - Elektrikli Electrical Chicken Rotisserie	1098x480x2020			183	1.07	26.4	48	5.100
EMP.8EED	Piliç Kızartma Makinesi - Elektrikli Electrical Chicken Rotisserie	1098x660x2020			220	1.47	26.4	48+48	7.000

Türkçe

PİLİÇ KIZARTMA MAKİNELERİ - ELEKTRİKLİ

- Pişirme tipi elektrikli olup, her rezistans ayrı ayrı kontrol edilebilir.
- Kapak camları temperlidir.
- Şiş ve cam kapak tutma kulpları ısıya dayanıklı bakalitir.
- Elektrik tesisatı yüksek ısıya dayanıklıdır.
- Çelik dişli sistemi sessiz bir çalışma imkanı sağlar.
- Paslanmaz çelik gövde.
- Bakımı ve temizliği kolaydır.
- Her şiş 6 piliç alır.

English

ELECTRICAL CHICKEN ROTISSERIE

- Roasting type operates electrically and each resistance may controlled separately.
- Heat resistant tempered glass doors.
- Spear and door handles are made of heat resistant bakelite.
- Steel gear system provides quiet operation.
- Electric system is resistant to high temperatures.
- Stainless steel body.
- Provides simple maintain and easy cleaning.
- Each spear takes 6 chicken.



Piliç Kızartma Makineleri (Gazlı)
Gas Chicken Rotisserie



Kod Code	Ürün Adı Description	Ebatlar Dimension mm			Ağırlık Weight kg	Net Net m³	Güç Power kw	Kapasite Capacity adet-pieces	Fiyatı Price Euro
		a	b	c					
EMP.3EG	Piliç Kızartma Makinesi - Gazlı Gas Chicken Rotisserie	1098x480x820			86	0.44	14.40	18	2.765
EMP.5EG	Piliç Kızartma Makinesi - Gazlı Gas Chicken Rotisserie	1098x480x1170			114	0.62	24.00	30	3.600
EMP.8EG	Piliç Kızartma Makinesi - Gazlı Gas Chicken Rotisserie	1098x480x2020			193	1.07	38.00	48	5.100
EMP.8EGD	Piliç Kızartma Makinesi - Gazlı Gas Chicken Rotisserie	1098x660x2020			230	1.47	38.00	48+48	7.000

Türkçe

PİLİÇ KIZARTMA MAKİNELERİ - GAZLI

- Lpg ve doğalgaza uyumludur.
- Kumanda muslukları emniyet ventillidir.
- Pişirme tipi radyanlı olup, her radyan ayrı ayrı kontrol edilebilir.
- Kapak camları temperlidir.
- Çelik dişli sistemi sessiz bir çalışma imkanı sağlar.
- Şiş ve cam kapak tutma kulpları ısıya dayanıklı bakalitir.
- Elektrik tesisatı yüksek ısıya dayanıklıdır.
- Paslanmaz çelik gövde.
- Bakımı ve temizliği kolaydır.
- Her şiş 6 piliç alır

English

GAS CHICKEN ROTISSERIE

- LPG or NG.
- Safety valve.
- Operates by radiant and each radiant can be controlled separately.
- Heat resistant tempered glass doors.
- Steel gear system provides quiet operation.
- Spear and door handles are made of heat resistant bakelite.
- Electrical fitting is durable to high temperatures.
- Stainless steel body.
- Easy cleaning.
- Each spear takes 6 chicken.





EMPERO

G|R|O|U|P

empero@empero.com.tr

Kafeterya
Cafe



empero@empero.com.tr

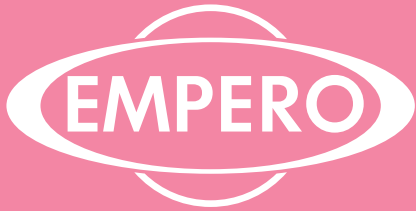

Portakal Sıkma Makinesi (Otomatik) / Orange Juicer (Automatic)

Çikolata Şelalesi / Chocolate

Sıcak Teşhir Ünitesi (Halojen Isıtıcı) / Hot Display Unit (Halogen Lamp)

Demlikli Çay Otomatı / Tea Maker With Pot

Çay ve Su Otomatları / Tea Maker & Hot Water Dispenser

Döner Ocakları (Gazlı) / Shawarma Machines, Gas

Altın Motorlu Camlı Döner Ocakları (Elektrikli - Gazlı) / Robax Glass Electrical - Gas Shawarma Machines (Motor at bottom)

Tost Makineleri (Elektrikli) / Toaster (Electrical)

Krep ve Waffle Makinesi / Crepe & Waffel Maker

Köpüklü Ayran Makinesi / Sparkling Ayran Maker

Elektrikli ve Gazlı Salamander Izgara / Electric & Gas Salamander Grill

Portakal Sıkma Makinesi (Otomatik)
Orange Juicer (Automatic)



Kod Code	Ürün Adı Description	Ebatlar Dimension mm			Ağırlık Weight kg	Net Net m³	Kapasite Capacity adet/dk-pcs/min	Fiyatı Price Euro
		a	b	c				
EMP.ORG.50	Otomatik Portakal Sıkma Makinesi Automatic Orange Juicer	580x600x830			81	0.28	25	2.250
EMP.ORG.51	Alt Stand Bottom Stand	600x630x880			31	0.33		550

Türkçe

OTOMATİK PORTAKAL SIKMA MAKİNESİ

ORG.50

- 0.25 kw 1500 D/Dk 220-240 V 50-60 Hz. sıkıcı motor gücü.
- 0.18 kw 1500 D/Dk 220-240 V 50-60 Hz. Üst hazne motor gücü.
- Güvenlik sensörü.
- Tek seferde 18 kg yükleme kapasitesi.
- 60-85 mm portakal çapı.
- Paslanmaz çelik alt stand.

English

ORANGE JUICER (AUTOMATIC)

ORG.50

- Squeezer motor power:0.25 kw 1500 rpm 220-240 V 50-60 Hz
- Top reservoir motor power:0.18 kw 1500 D/Dk 220-240 V 50-60 Hz
- Safety switch .
- Loading capacity:18 kg/time.
- Orange diameter: 60-85mm
- Stainless steel bottom stand.



Plastik hazne
fiyata dahil değildir.

Plastic container
is not included
is not in the price.

Çikolata Şelalesi Chocolate Fountain



Kod Code	Ürün Adı Description	Ebatlar Dimension mm		Ağırlık Weight kg	Net Net m³	Fiyatı Price Euro
		a	b			
EMP.CF.01	Çikolata Şelalesi Chocolate Fountain	350x880		30	0.2	750

Türkçe

ÇIKOLATA ŞELELESİ

- 0.18 Kw 220 V motor gücü.
- Limit termostat kontrol.
- Ortalama 45°C çalışma ısısı.
- 54 cm çikolata akma mesafesi.
- Kolay temizlik imkanı.
- Paslanmaz çelik gövde.

English

CHOCOLATE FOUNTAIN

- 0.18 Kw 220 V motor power.
- Safety thermostat.
- 45°C Operation degree.
- 54 cm chocolate flow distance.
- Easy cleaning.
- Stainless steel body.



Sıcak Teşhir Ünitesi (Halojen Isıtıcı) Hot Display Unit (Halogen Lamp)



Kod Code	Ürün Adı Description	Ebatlar Dimension mm			Ağırlık Weight kg	Net Net m³	Güç Power kw	Kapasite Capacity GN	Fiyatı Price Euro
		a	b	c					
EMP.STU.01	Sıcak Teşhir Ünitesi Hot Display Unit	725	570	562	15	0.23	1.3	2x1/1	550



Kod Code	Ürün Adı Description	Ebatlar Dimension mm			Ağırlık Weight kg	Net Net m³	Güç Power kw	Kapasite Capacity GN	Fiyatı Price Euro
		a	b	c					
EMP.STU.02	Sıcak Teşhir Ünitesi Hot Display Unit	1040	570	562	22	0.33	1.9	3x1/1	700

Türkçe

SICAK TEŞHİR ÜNİTESİ

- 220 V motor gücü.
- Termostat kontrollü.
- Pleksiglas üst raf.

English

HOT DISPLAY UNIT

- 220 V motor power.
- Safety thermostat.
- Plexiglass top shelf.

Demlikli Çay Otomatı
Tea Maker With Pot



EMP.DCY.250

EMP.DCY.120

Kod Code	Ürün Adı Description	Ebatlar Dimension mm			Ağırlık Weight kg	Net Net m ³	Güç Power kw	Kapasite Capacity adet/dk-pcs/min	Fiyatı Price Euro
		a	b	c					
EMP.DCY.120	Demlikli Çay Otomatı 120 Bardak Tea Maker With Pot 120 Cups	294x367x400			15	0.04	2	13	290
EMP.DCY.250	Demlikli Çay Otomatı 250 Bardak Tea Maker With Pot 250 Cups	352x425x440			20	0.06	2.5	23	330
EMP.DCY.350	Demlikli Çay Otomatı 350 Bardak Tea Maker With Pot 350 Cups	415x487x455			27	0.09	3.5	37	390

Türkçe

DEMLİKLİ ÇAY OTOMATI

- Termostat kontrol ünitesi.
- Isı yalıtımlı.
- İkaz lambası.
- Paslanmaz çelik iç hazne.

English

TEA MAKER WITH POT

- Thermostat control unit.
- Heating isolation.
- Warning lamp.
- Stainless steel interior reservoir.



EMP.DCY.350

Çay ve Su Otomatları
Tea Maker & Hot Water Dispenser

EMP.CY.80
Çay Otomatı
Tea Maker



EMP.SU.80
Su Otomatı
Hot Water Dispenser

Kod Code	Ürün Adı Description	Ebatlar Dimension mm	Ağırlık Weight kg	Net Net m ³	Güç Power kw	Kapasite Capacity lt	Fiyatı Price Euro
EMP.CY.80	Çay Otomatı 80 Bardak Tea Maker 80 Cups	Q 235x440	4	0.010	1.75	8	145
EMP.CY.120	Çay Otomatı 120 Bardak Tea Maker 120 Cups	Q 255x485	5	0.012	1.75	13	155
EMP.CY.250	Çay Otomatı 250 Bardak Tea Maker 250 Cups	Q 320x510	7	0.017	2.5	23	185
EMP.CY.400	Çay Otomatı 400 Bardak Tea Maker 400 Cups	Q 390x540	10	0.021	5	40	370
EMP.SU.80	Su Otomatı 80 Bardak Hot Water Dispenser 80 Cups	Q 235x440	3.5	0.010	1.75	8	130
EMP.SU.120	Su Otomatı 120 Bardak Hot Water Dispenser 120 Cups	Q 255x485	3.7	0.012	1.75	13	140
EMP.SU.250	Su Otomatı 250 Bardak Hot Water Dispenser 250 Cups	Q 320x510	5.5	0.017	2.5	23	170
EMP.SU.400	Su Otomatı 400 Bardak Hot Water Dispenser 400 Cups	Q 390x540	8	0.021	5	40	325

Türkçe

ÇAY VE SU OTOMATLARI

- Termostat kontrol ünitesi.
- Paslanmaz çelik gövde.

English

TEA MAKER & HOT
WATER DISPENSER

- Thermostat control unit.
- Stainless steel body.



Döner Ocakları (Gazlı) Shawarma Machines, Gas



Üstten motorlu Döner Ocakları - Gazlı / Gas- Shawarma Machines (Motor on Top)

Kod Code	Ürün Adı Description	Ebatlar Dimension mm			Ağırlık Weight kg	Net Net m³	Güç Power kw	Isıtıcı Burner	Fiyatı Price Euro
		a	b	c					
EMP.DN.220	Döner Ocağı - Gazlı Shawarma Machine - Gas	752x546x785			25	0.33	8.3	3	610
EMP.DN.221	Döner Ocağı - Gazlı Shawarma Machine - Gas	752x546x1152			31	0.39	11.1	4	700
EMP.DN.222	Döner Ocağı - Gazlı Shawarma Machine - Gas	760x546x1320			35	0.46	13.9	5	820

Türkçe

ÜSTTEN MOTORLU DÖNER OCAKLARI (GAZLI)

- Lpg veya doğalgazla çalışabilme imkanı.
- 220V-50Hz enerji.
- Magnet emniyet ventilli musluklar.
- Ayarlanabilir döner şişi.
- Çift yöne dönebilme özelliği.
- Hijyenik ve emniyetli.
- Paslanmaz çelik gövde.

English

SHAWARMA MACHINES, GAS (MOTOR ON TOP)

- Lpg or naturel gas.
- 220V-50Hz
- Magnet safety valve.
- Adjustable spear.
- Dual direction option.
- Hygienic and safe.
- Stainless steel body.



Alttan motorlu Döner Ocakları Gazlı / Gas- Shawarma Machines (Motor at Bottom)

Kod Code	Ürün Adı Description	Ebatlar Dimension mm			Ağırlık Weight kg	Net Net m³	Güç Power kw	Isıtıcı Burner	Fiyatı Price Euro
		a	b	c					
EMP.DN.150	Döner Ocağı - Gazlı Shawarma Machine - Gas	737x619x978			30	0.40	8.3	3	780
EMP.DN.151	Döner Ocağı - Gazlı Shawarma Machine - Gas	748x619x1047			38	0.46	11.1	4	860
EMP.DN.152	Döner Ocağı - Gazlı Shawarma Machine - Gas	726x621x1217			40	0.53	12.5	5	960

Türkçe

ALTTAN MOTORLU DÖNER OCAKLARI (GAZLI)

- Lpg veya doğalgazla çalışabilme imkanı.
- 220V-50Hz enerji.
- Magnet emniyet ventilli musluklar.
- Alttan hareketli kızaklar döner etinin ısıtıcıya yaklaşmasını sağlar.
- Ayarlanabilir döner şişi.
- Çift yöne dönebilme özelliği.
- Hijyenik ve emniyetli.
- Paslanmaz çelik gövde.

English

SHAWARMA MACHINES, GAS (MOTOR AT BOTTOM)

- Lpg or naturel gas.
- 220V-50Hz
- Magnet safety valve.
- Sliding bottom housing of the spear provides shawarma meat to get closer to burner.
- Adjustable spear.
- Dual direction option.
- Hygienic and safe.
- Stainless steel body.



Altan Motorlu Camlı Döner Ocakları (Elektrikli - Gazlı)

Robax Glass Electrical - Gas Shawarma Machines (Motor at bottom)



Altan motorlu Camlı Döner Ocakları - Elektrikli / Electric - Robax Shawarma Machines (Motor at Bottom)

Kod Code	Ürün Adı Description	Ebatlar Dimension mm			Ağırlık Weight kg	Net Net m³	Güç Power kw	Isıtıcı Burner	Fiyatı Price Euro
		a	b	c					
EMP.DN.170	Döner Ocağı - Elektrikli Shawarma Machine - Electrical	710	667	978	30	0.40	4.2	3	1.000
EMP.DN.171	Döner Ocağı - Elektrikli Shawarma Machine - Electrical	741	632	1143	40	0.46	5.6	4	1.130
EMP.DN.172	Döner Ocağı - Elektrikli Shawarma Machine - Electrical	738	667	1305	42.5	0.53	7	5	1.250

Türkçe

ALTAN MOTORLU CAMLI DÖNER OCAKLARI (ELEKTRİKLİ)

- Düşük ve yüksek 2 kademeli pişirme sıcaklığı.
- 380V-50Hz enerji.
- ROBAX Color S termal cam.
- Altan hareketli kızaklar döner etinin ısıtıcıya yaklaşmasını sağlar.
- Ayarlanabilir döner şişi.
- Çift yöne dönebilme özelliği.
- Hijyenik ve emniyetli.
- Paslanmaz çelik gövde.

English

ROBAX GLASS ELECTRICAL SHAWARMA MACHINES (MOTOR AT BOTTOM)

- Low and high two stage cooking temperature.
- 380V-50 Hz
- ROBAX Color S thermal glass.
- Sliding bottom housing of the spear provides shawarma meat to get closer to burner
- Adjustable spear
- Dual direction option.
- Hygienic and safe.
- Stainless steel body.



Altan motorlu Camlı Döner Ocakları - Gazlı / Gas - Robax Shawarma Machines (Motor at Bottom)

Kod Code	Ürün Adı Description	Ebatlar Dimension mm			Ağırlık Weight kg	Net Net m³	Güç Power kw	Isıtıcı Burner	Fiyatı Price Euro
		a	b	c					
EMP.DN.210	Döner Ocağı - Gazlı Shawarma Machine - Gas	737	667	978	31.5	0.40	8.3	3	1.000
EMP.DN.211	Döner Ocağı - Gazlı Shawarma Machine - Gas	737	667	1137	40	0.46	11.1	4	1.130
EMP.DN.212	Döner Ocağı - Gazlı Shawarma Machine - Gas	737	667	1305	42.5	0.53	13.9	5	1.250

Türkçe

ALTAN MOTORLU CAMLI DÖNER OCAKLARI (GAZLI)

- Lpg veya doğalgazla çalışabilme imkanı.
- 220V-50Hz enerji.
- ROBAX Color S termal cam.
- Magnet emniyet ventilli musluklar.
- Altan hareketli kızaklar döner etinin ısıtıcıya yaklaşmasını sağlar.
- Ayarlanabilir döner şişi.
- Çift yöne dönebilme özelliği.
- Hijyenik ve emniyetli.
- Paslanmaz çelik gövde.

English

ROBAX GLASS GAS SHAWARMA MACHINES (MOTOR AT BOTTOM)

- Lpg or naturel gas.
- 220V-50 Hz
- ROBAX Color S thermal glass.
- Magnet safety valves.
- Sliding bottom housing of the spear provides shawarma meat to get closer to burner
- Adjustable spear
- Dual direction option.
- Hygienic and safe.
- Stainless steel body.



Tost Makineleri (Elektrikli) Toaster (Electrical)



Kod Code	Ürün Adı Description	Ebatlar Dimension mm			Ağırlık Weight kg	Net Net m³	Güç Power kw	Fiyatı Price Euro
		a	b	c				
EMP.101	Tost Makineleri (Tekli) Toaster (Single)	400	360	210	30	0.03	1.75	330

Türkçe

TOST MAKİNELERİ (ELEKTRİKLİ)

- 220V 50 Hz enerji.
- Izgara olarak kullanabilme özelliği.
- Hijyenik ve emniyetli.
- Paslanmaz çelik gövde.

English

TOASTER (ELECTRICAL)

- 220V 50 Hz energy.
- Capable for operation as a grill.
- Hygienic and safe.
- Stainless steel body.



Kod Code	Ürün Adı Description	Ebatlar Dimension mm			Ağırlık Weight kg	Net Net m³	Güç Power kw	Fiyatı Price Euro
		a	b	c				
EMP.102	Tost Makineleri (Blok) Toaster (Block)	540	300	210	33	0.04	1.95	390

Türkçe

TOST MAKİNELERİ (ELEKTRİKLİ)

- 220V 50 Hz enerji.
- Izgara olarak kullanabilme özelliği.
- Hijyenik ve emniyetli.
- Paslanmaz çelik gövde.

English

TOASTER (ELECTRICAL)

- 220V 50 Hz energy.
- Capable for operation as a grill.
- Hygienic and safe.
- Stainless steel body.



Kod Code	Ürün Adı Description	Ebatlar Dimension mm			Ağırlık Weight kg	Net Net m³	Güç Power kw	Fiyatı Price Euro
		a	b	c				
EMP.103	Tost Makineleri (Çiftli) Toaster (Double)	540	300	210	35	0.04	2.95	465

Türkçe

TOST MAKİNELERİ (ELEKTRİKLİ)

- 220V 50 Hz enerji.
- Izgara olarak kullanabilme özelliği.
- Hijyenik ve emniyetli.
- Paslanmaz çelik gövde.

English

TOASTER (ELECTRICAL)

- 220V 50 Hz energy.
- Capable for operation as a grill.
- Hygienic and safe.
- Stainless steel body.



Konveyörlü Ekmek Kızartma Makinesi Conveyor Toaster

Kod Code	Ürün Adı Description	Ebatlar Dimension mm			Ağırlık Weight kg	Net Net m³	Güç Power kw	Fiyatı Price Euro
		a	b	c				
EMP.MEK010	Konveyörlü Ekmek Kızartma Makinesi Conveyor Toaster	478	600	420	35	0.12	3.5	870

Türkçe

KONVEYÖRLÜ EKMEK KIZARTMA MAKİNESİ

- 600 dilim / saat kapasitesi.
- Termostatik kontrol.
- Paslanmaz çelik taşıyıcı tel.
- Kolay temizlenebilen ve hijyeniktir.
- Paslanmaz çelik gövde.

English

CONVEYOR TOASTER

- Capacity: 600 bread slice / hour.
- Thermostatic controller.
- Stainless steel conveyor wire.
- Easy to clean and hygienic.
- Stainless steel body.

Kod Code	Elektrik Girişi Electric Input	Kablo Kesiti Cable Cross Section
EMP.MEK010	230 V.AC N PE	3 x 2.5



Krep ve Waffle Makinesi Crepe & Waffel Maker



Kod Code	Ürün Adı Description	Ebatlar Dimension mm	Ağırlık Weight kg	Net Net m³	Güç Power kw	Kapasite Capacity cm	Fiyatı Price Euro
EMP.KR.010	Krep Makinesi - Classico Crepe Maker - Classico	450x520x240	19	0.06	2,2	40 Ø	375

Türkçe

KREP MAKİNESİ

- 220 V 50 Hz. enerji.
- Estetik ve fonksiyonel tasarım.
- Üst ızgaralar teflon kaplama.
- Paslanmaz çelik gövde.

English

CREPE MAKER

- 220 V 50 Hz. energy.
- Functionel design.
- Stainlees steel body, baking plate mode of castiron.
- Stainlees steel body.



Kod Code	Ürün Adı Description	Ebatlar Dimension mm	Ağırlık Weight kg	Net Net m³	Güç Power kw	Kapasite Capacity cm	Fiyatı Price Euro
EMP.KR.020	Krep Makinesi - Classico Crepe Maker - Classico	900x520x240	37	0.12	2x2,2	2x(40 Ø)	675

Türkçe

KREP MAKİNESİ

- 220 V 50 Hz. enerji.
- Estetik ve fonksiyonel tasarım.
- Üst ızgaralar teflon kaplama.
- Paslanmaz çelik gövde.

English

CREPE MAKER

- 220 V 50 Hz. energy.
- Functionel design.
- Stainlees steel body, baking plate mode of castiron.
- Stainlees steel body.



Kod Code	Ürün Adı Description	Ebatlar Dimension mm	Ağırlık Weight kg	Net Net m³	Güç Power kw	Kapasite Capacity cm	Fiyatı Price Euro
EMP.WF.010	Waffle Makinesi - Waffelino Waffel Maker - Waffelino	300x320x300	31	0.03	2,2	2x(10x17)	330

Türkçe

WAFFLE MAKİNESİ

- 220 V 50 Hz. enerji.
- Estetik ve fonksiyonel tasarım.
- Üst ızgaralar teflon kaplama.
- Paslanmaz çelik gövde.

English

WAFFEL MAKER

- 220 V 50 Hz. energy.
- Functionel design.
- Stainlees steel body, baking plate mode of castiron.
- Stainlees steel.



Kod Code	Ürün Adı Description	Ebatlar Dimension mm	Ağırlık Weight kg	Net Net m³	Güç Power kw	Kapasite Capacity cm	Fiyatı Price Euro
EMP.WF.020	Waffle Makinesi - Waffelino Waffel Maker - Waffelino	600x320x300	63	0.06	2x2,2	4x(10x17)	550

Türkçe

WAFFLE MAKİNESİ

- 220 V 50 Hz. enerji.
- Estetik ve fonksiyonel tasarım.
- Üst ızgaralar teflon kaplama.
- Paslanmaz çelik gövde.

English

WAFFEL MAKER

- 220 V 50 Hz. energy.
- Functionel design.
- Stainlees steel body, baking plate mode of castiron.
- Stainlees steel.

Köpüklü Ayran Makinesi Sparkling Ayran Maker



Kod Code	Ürün Adı Description	Ebatlar Dimension mm			Ağırlık Weight kg	Net Net m³	Kapasite Capacity lt	Fiyatı Price Euro
		a	b	c				
EMP.AYR.40	Köpüklü Ayran Makinesi (Ahşap Kaplamalı) Sparkling Ayran Maker (Wooden Decorated)	600	600	1350	78	0.5	40	1.600

Türkçe

KÖPÜKLÜ AYRAN MAKİNESİ

- 220 V / 50 Hz
- 200 Watt.
- 40 litre kapasiteli.
- Kazan temizlik ve tahliye vanası.
- Bardak doldurma musluğu ve alt süzgeci.
- Köpüklü veya köpüksüz ayran doldurma seçeneği.
- İç aydınlatmalı.
- Gövde renk seçenekleri veya reklam & marka kaplama opsiyonu.

English

SPARKLING AYRAN MAKER

- 220 V/ 50 Hz
- 200 Watt.
- 40 lt.capacities.
- Tank cleaning and discharge valve.
- Glass filling sink and sub filter.
- Foomly or foamless yogurt drink options.
- Interior lighting.
- Body colour or brand & advertisement options.



Kod Code	Ürün Adı Description	Ebatlar Dimension mm			Ağırlık Weight kg	Net Net m³	Kapasite Capacity lt	Fiyatı Price Euro
		a	b	c				
EMP.AYR.40-P	Köpüklü Ayran Makinesi (Paslanmaz Çelik) Sparkling Ayran Maker (Stainless Steel)	600	600	1350	70	0.5	40	1.500

Türkçe

KÖPÜKLÜ AYRAN MAKİNESİ

- 220 V / 50 Hz
- 200 Watt.
- 40 litre kapasiteli.
- Kazan temizlik ve tahliye vanası.
- Bardak doldurma musluğu ve alt süzgeci.
- Köpüklü veya köpüksüz ayran doldurma seçeneği.
- İç aydınlatmalı.

English

SPARKLING AYRAN MAKER

- 220 V/ 50 Hz
- 200 Watt.
- 40 lt.capacities.
- Tank cleaning and discharge valve.
- Glass filling sink and sub filter.
- Foomly or foamless yogurt drink options.
- Interior lighting.



Elektrikli ve Gazlı Salamander Izgara

Electric & Gas Salamander Grill



Kod Code	Ürün Adı Description	Ebatlar Dimension mm			Ağırlık Weight kg	Net Net m³	Güç Power kw	Fiyatı Price Euro
		a	b	c				
EMP.PSE020	Elektrikli Salamander Izgara Electric Salamander Grill	660	530	470	62	0.16	3.4	870

Kod Code	Elektrik Girişi Electric Input	Kablo Kesiti Cable Cross Section
EMP.PSE020	230 V.AC 1N PE	3 x 2.5

Türkçe

ELEKTRİKLİ SALAMANDER IZGARA

- Termostatik kumanda.
- Isıtma sistemi yukarı ve aşağıya yakınlaştırılabilir.
- Kolay temizlenebilir ve hijyeniktir.
- Paslanmaz çelik gövde.

English

ELECTRIC SALAMANDER GRILL

- Thermostatic controller.
- Slides can be adjusted on a different height.
- Easy to clean and hygienic.
- Stainless steel body.



Kod Code	Ürün Adı Description	Ebatlar Dimension mm			Ağırlık Weight kg	Net Net m³	Güç Power kw	Fiyatı Price Euro
		a	b	c				
EMP.PSG.3	3 Brülörlü Gazlı Salamander Izgara 3 Burners Gas Salamander Grill	835	440	600	42	0.22	9	800
EMP.PSG.4	4 Brülörlü Gazlı Salamander Izgara 4 Burners Gas Salamander Grill	970	440	600	50	0.26	12	950
EMP.PSG.5	5 Brülörlü Gazlı Salamander Izgara 5 Burners Gas Salamander Grill	1105	440	600	59	0.30	15	1.100
EMP.PSG.6	6 Brülörlü Gazlı Salamander Izgara 6 Burners Gas Salamander Grill	1240	440	600	67	0.33	18	1.300

Kod Code	Gaz Tüketim Değeri Gas Consumption Ng	Gaz Tüketim Değeri Gas Consumption Lpg
EMP.PSG.3	1 m³/h	0.7 kg/h
EMP.PSG.4	1.3 m³/h	0.9 kg/h
EMP.PSG.5	1.6 m³/h	1.1 kg/h
EMP.PSG.6	1.9 m³/h	1.4 kg/h

Türkçe

GAZLI SALAMANDER IZGARA

- Isıtma sistemi yukarı ve aşağı yakınlaştırılabilir.
- Ventilli gaz musluğu aracılığıyla ısı derecesi ayarı.
- Cihaza nemlendirme özelliği katan hareketli alt tepsi.
- Paslanmaz çelik gövde.

English

GAS SALAMANDER GRILL

- Slides can be adjusted on a different height.
- Gas valve provides temperature control.
- Moisturizing option by the removable tray.
- Stainless steel body.

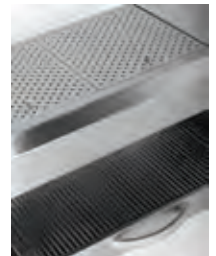

Bulařıkxane
Dishwasher



empero@empero.com.tr



Bardak Yıkama Makinesi / Glasswasher

Set Altı Bulaşık Makinesi / Undercounter Type Dishwasher

Giyotin Tipi Bulaşık Makinesi / Hood Type Dishwasher

Konveyörlü Bulaşık Makineleri (Kurutma Ünitesi) / Conveyor Type Dishwasher (Drying Unit)

Bardak Yıkama Makinesi Glasswasher



Kod Code	Ürün Adı Description	Ebatlar Dimension mm			Ağırlık Weight kg	Net Net m³	Kapasite Capacity bardak/saat-glass/Hour	Fiyatı Price Euro
		a	b	c				
EMP.1100	Bardak Yıkama Makinesi Glasswasher	480	580	720	41	0.02	1000	1.450

Türkçe

BARDAK YIKAMA MAKİNESİ

- Parlaticı pompası : Standart.
- Drenaj pompası : Standart.
- 3,2 kw makine gücü.
- 90°-120°,-180° C saniye olmak üzere 3 farklı program özelliği.
- 220 v işletim sistemi.
- 400x400 mm basket.

English

GLASSWASHER

- Built in rinse aid dispenser.
- Drain pump.
- Total Power:3,2 kw.
- Programme options: 90°,-120°,-180° C seconds.
- 220 v operating system.
- 400x400 mm basket dimension.



Set Altı Bulaşık Makinesi Undercounter Type Dishwasher

Kod Code	Ürün Adı Description	Ebatlar Dimension mm			Ağırlık Weight kg	Net Net m³	Kapasite Capacity tabak/saat-plate/hour	Fiyatı Price Euro
		a	b	c				
EMP.500	Set Altı Bulaşık Makinesi Undercounter Type Dishwasher	590	700	820	67	0.33	500	1.500
	Su Basınç Pompası Fiyat Farkı Price Difference for Water Pressure Pump							350

Su basınç pompası şebeke basıncının 2 bar'ın altında olduğu yerlerde kullanılır.

Water pressure pump is required for below 2 bar water connections.

Türkçe

SET ALTI BULAŞIK MAKİNESİ

- Drenaj pompası : Standart.
- 90°-120°,-180° C saniye olmak üzere 3 farklı program özelliği.
- 0.55 kw 2800 D/Dk motor gücü.
- 6 kw 220 V makine toplam gücü.
- 2.5 kw yıkama tankı gücü.
- 3 kw durulama tankı gücü.
- Paslanmaz çelik rezistans.
- 320 mm maksimum tabak çapı.
- 2.5 lt/sefer su sarfiyatı.
- Manyetik kapı güvenlik sensörü.
- Kapak kapandığında programın durduğu yerden başlatma özelliği.
- Tam ve otomatik yıkama 55° C gerçekleşirken sıcak su ile durulama işlemi 80°-85° C de gerçekleşir.
- Paslanmaz çelik gövde.

English

UNDERCOUNTER TYPE DISHWASHER

- Drainage pump : Standart.
- Programme options: 90°,-120°,-180° C seconds.
- Motor Power:0.55 kw 2800 rpm.
- Total Power:6 kw 220 V
- Tank heating power:2.5 kw
- Rinse boiler heating:3 kw
- Stainless steel resistance.
- Maximum plate diameter:320 mm
- Water consumption: 2.5 lt/time.
- Magnetic security switch.
- Programme continues the process by closing of the door.
- Full automatic washing operation at 55°C, rinsing operation with hot water at 80-85°C.
- Stainless steel body.



Giyotin Tipi Bulaşık Makinesi
Hood Type Dishwasher



Kod Code	Ürün Adı Description	Ebatlar Dimension mm			Ağırlık Weight kg	Net Net m³	Kapasite Capacity tabak/saat-plate/hour	Fiyatı Price Euro
		a	b	c				
EMP.1000	Giyotin Tipi Bulaşık Makinesi Hood Type Dishwasher	696x765x1485			120	0.79	1000	2.200
	Su Basınç Pompası Fiyat Farkı Price Difference for Water Pressure Pump							350

Kod Code	Ürün Adı Description	Ebatlar Dimension mm			Net Net m³	Fiyatı Price Euro
		a	b	c		
EMP.TB.01	Tabak Basketi Dish Basket	500x500x110			0.02	15
EMP.KC.01	Kaşık Çatal Basketi Cutlery Basket	500x500x110			0.02	14
EMP.BB.01	Bardak Basketi Glass Basket	500x500x110			0.02	14

Su basınç pompası şebeke basıncının 2 bar'ın altında olduğu yerlerde kullanılır.

Water pressure pump is required for below 2 bar water connections.

Türkçe

GIYOTİN TİPİ BULAŞIK MAKİNESİ

- 60°,-90°,-120°,-180° C saniye program özelliği.
- 0.55 kw 2800 D/Dk motor gücü.
- 9.5 kw 380 V makine toplam gücü.
- 2.8 kw tank ısıtma gücü.
- 6 kw durulama suyu boyler gücü.
- Paslanmaz çelik rezistans.
- Termostat kontrolü. (Yıkama ısısı 60°)
- 2.5 lt/sefer su sarfiyatı.
- Manyetik kapı güvenlik sensörü.
- Kapak kapandığında programın durduğu yerden başlatma özelliği.
- Tam ve otomatik yıkama 55° C gerçekleşirken sıcak su ile durulama işlemi 80°-85° C de gerçekleşir.
- Paslanmaz çelik gövde.

English

HOOD TYPE DISHWASHER

- 60°, 90°, 120°, 180° C seconds programme options.
- Motor Power:0.55 kw 2800 rpm.
- Total Power:9,5 kw 380 V
- Tank heating power:2.8 kw
- Rinse boiler heating:6 kw
- Stainless steel resistance.
- Thermostat control. (washing temperature:60°C)
- Water consumption: 2.5 lt/time.
- Magnetic security switch.
- Programme continues the process by closing of the door.
- Full automatic washing operation at 55° C rinsing operation with hot water at 80°-85° C.
- Stainless steel body.



Konveyörlü Bulaşık Makineleri (Kurutma Ünitesi) Conveyor Type Dishwasher (Drying Unit)

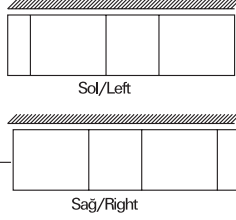

Lütfen Giriş Yönünü Belirtiniz.
Please Point Out the Inlet Direction.

Kod Code	Ürün Adı Description	Ebatlar Dimension mm			Ağırlık Weight kg	Net Net m ³	Kapasite Capacity kg/saat-kg/time	Fiyatı Price Euro
		a	b	c				
EMP.2000-SAG-R	Konveyörlü Bulaşık Makineleri Conveyor Type Dishwasher with Drying Tunnel	2040	830	1850	303	3.21	2000	7.000
EMP.2000-SOL-L	Konveyörlü Bulaşık Makineleri Conveyor Type Dishwasher with Drying Tunnel	2040	830	1850	303	3.21	2000	7.000
EMP.2000.ÖY- SAG-R	Konveyörlü Bulaşık Makineleri (Ön Yıkamalı) Conveyor Type Dishwasher with Drying Tunnel - (With Prewashing Unit)	2790	830	1850	378	4.6	2000	9.000
EMP.2000.ÖY- SOL-L	Konveyörlü Bulaşık Makineleri (Ön Yıkamalı) Conveyor Type Dishwasher with Drying Tunnel - (With Prewashing Unit)	2790	830	1850	378	4.6	2000	9.000

Türkçe

KONVEYÖRLÜ BULAŞIK MAKİNELERİ

- Kurutma tüneli : Standart.
- İki hızlı konveyör bandı.
- İki adet yıkama motoru.
- 27 KW boyler gücü.
- 9 KW tank gücü.
- 9 KW kurutma ünitesi motor gücü.
- Ön yıkamasız makineler için motor gücü ;
0.35 Kw 2800 D/Dk x 2
- Ön yıkamalı makineler için motor gücü ;
0.35 Kw 2800 D/Dk x 3
- 50 Kw 380 V makine toplam gücü.
- Tam ve otomatik yıkama 55° C gerçekleşirken sıcak su ile durulama işlemi 80°-85° C de gerçekleşir.
- 24 voltluk kontrol akımı kullanım süresince emniyet temin eder.
- Manyetik kapı güvenlik sensörü.
- Paslanmaz çelik rezistanlar.
- Paslanmaz çelik gövde.

English

CONVEYOR TYPE DISHWASHER DRYING TUNNEL

- Drying Tunnel:Standart.
- Two speed conveyor band.
- Two pieces of washing motors.
- Boiler power: 27 KW
- Tank Power: 9 KW
- Drying unit motor power: 9 KW
- Motor property for conveyor type dishwasher without prewashing unit types
0.35 kw 2800 rpm x 2
- Motor property for pre-washing machines
0.35 kw 2800 rpm x 3
- Total power: 50 kw 380 V
- Full automatic washing operation at 55° C, rinsing operation with hot water at 80-85° C.
- 24 v controlling current provides security during the operation.
- Magnetic security switch.
- Stainless steel resistances.
- Stainless steel body.



EMPERO

G|R|O|U|P

empero@empero.com.tr

Piřirme-Snack Serisi
Cooking-Snack Series



empero@empero.com.tr



Davlumbazsız Pişirme İstasyonu / Multi Cooking Station (Hoodles)

Gazlı ve Elektrikli Ocaklar / Gas & Electric Ranges

Elektrikli Fritözler / Electric Fryers

Elektrikli Makarna Haşlama-Patates Dinlendirme / Electric Pasta Cooker-Chips Scuttle

Gazlı Izgaralar / Gas Grills

Elektrikli Izgaralar / Electric Grills

Gazlı Lavataşlı Izgaralar / Gas Lavastone Grills

Gazlı Sulu Izgara / Gas Vapor Grill

Elektrikli Benmariler / Electric Bain maries

Set Altı ve Ara Tezgahlar / Worktop and Undercounter Cabinet

Set Altı ve Ara Tezgahlar / Worktop and Undercounter Cabinet

Davlumbazsız Pişirme İstasyonu
Multi Cooking Station (Hoodles)



Kod Code	Ürün Adı Description	Ebatlar Dimensions mm			Ağırlık Weight kg	Net Net m³	Güç Power kw	Fiyatı Price Euro
		a	b	c				
EMP.MCS.01	Davlumbazsız Pişirme İstasyonu Multi Cooking Station (Hoodles)	1000x850x1200			290	1.02	15	7.250
EMP.MCS.02	Davlumbazsız Pişirme İstasyonu Multi Cooking Station (Hoodles)	1400x850x1200			345	1.4	15	8.250

Kod Code	Elektrik Girişi Electric Input	Kablo Kesiti Cable Cross Section mm²
EMP.MCS.01	400 V. AC 3N PE	5x2,5
EMP.MCS.02	400 V. AC 3N PE	5x2,5

	Ürün Adı Description	Fiyatı Price Euro
Y.EMP.MCS.001	Karbon Filtre Carbon filter	60
Y.EMP.MCS.002	Zt filtre Zt filtre	120

Türkçe

DAVLUMBABZSIZ PİŞİRME İSTASYONU

- 15 Kw-380 V makine toplam gücü.
- Koku ve dumanı engelleyen özel filtre sistemi ozon teknolojili davlumbazsız pişirme ünitesi.
- Dijital ayarlanabilir hava emiş gücü.
- Tek tuşla ortam havasını temizleme fonksiyonu.
- Kendi içinde kaçak akım rölesi.
- Dijital kontrol paneli.
- Çıkarılabilir yağ toplama haznesi.
- Kolay temizlenebilir ve hijyenik.
- Paslanmaz çelik gövde.

English

MULTI COOKING STATION (HOODLES)

- 15Kw-380 V total power.
- Smokeless and odorless filter system ozon technology without using exhaust hood.
- Digital adjustable air absorption power.
- Just environment air cleaning with one button.
- Inside residual current device.
- Digital control panel.
- Detachable grease cup.
- Easy cleaning.
- Stainless steel body.

- Ünite içerisindeki ürünler fiyata dahil değildir.
- Products on unit are not included in price.



EMP.MCS.01+EMP.6IE020+EMP.6SE010



EMP.MCS.01+EMP.6SE010
EMP.6ME010+EMP.6KE010

GAZLI ve ELEKTRİKLİ OCAKLAR
 Gas & Electric Ranges

Kod Code	Ürün Adı Description	Ebatlar Dimension mm			Ağırlık Weight kg	Net Net m³	Güç Power kw	Fiyatı Price Euro
		a	b	c				
EMP.6KG010	2 Brülör'lü Gazlı Ocak 2 Burner Gas Range	400	635	285	24	0.11	5.3	410

Kod Code	Gaz Tüketim Değeri Gas Consumption Ng	Gaz Tüketim Değeri Gas Consumption Lpg
EMP.6KG010	0,6 m³/h	0,4 kg/h



Kod Code	Ürün Adı Description	Ebatlar Dimension mm			Ağırlık Weight kg	Net Net m³	Güç Power kw	Fiyatı Price Euro
		a	b	c				
EMP.6KG020	4 Brülör'lü Gazlı Ocak 4 Burner Gas Range	600	635	285	44	0.17	10.6	675

Kod Code	Gaz Tüketim Değeri Gas Consumption Ng	Gaz Tüketim Değeri Gas Consumption Lpg
EMP.6KG020	1,1 m³/h	0,8 kg/h



Kod Code	Ürün Adı Description	Ebatlar Dimension mm			Ağırlık Weight kg	Net Net m³	Güç Power kw	Fiyatı Price Euro
		a	b	c				
EMP.6KE010	2 Pleyt'li Elektrikli Ocak 2 Hot Plate Electric Range	400	635	285	20	0.11	3.5	330

Kod Code	Elektrik Girişi Electric Input	Kablo Kesiti Cable Cross Section mm²
EMP.6KE010	230 V. AC 1N PE	3 X 2,5



Kod Code	Ürün Adı Description	Ebatlar Dimension mm			Ağırlık Weight kg	Net Net m³	Güç Power kw	Fiyatı Price Euro
		a	b	c				
EMP.6KE020	4 Pleyt'li Elektrikli Ocak 4 Hot Plate Electric Range	600	635	285	34	0.17	7	575

Kod Code	Elektrik Girişi Electric Input	Kablo Kesiti Cable Cross Section mm²
EMP.6KE020	400 V. AC 3N PE	5 X 2,5

Türkçe
GAZLI OCAKLAR

- Lpg ve Ng ile çalışabilme özelliği.
- Magnet emniyet ventilli musluklar.
- Özel emaye kaplı güçlü ızgara.
- Kademeli şalter.
- Çift yanışlı brülör.
- Her brülör için piezzo çakmak ile kontrol.
- Kolay temizlenebilir ve hijyeniktir.
- Paslanmaz çelik gövde.

ELEKTRİKLİ OCAKLAR

- 6 kademeli şalter.
- Kolay temizlenebilir ve hijyeniktir.
- Paslanmaz çelik gövde.

English
GAS RANGES

- Lpg or Natural Gas.
- Magnet safety valves.
- Solid enamelled cast iron.
- Positioned switch.
- Double ring burner.
- Piezo electric ignition system for each module.
- Easy to clean and hygienic.
- Stainless steel body.

ELECTRIC RANGES

- 6 position switch.
- Easy to clean and hygienic.
- Stainless steel body.



EMP.6KG020+EMP.TS020



EMP.6KE010+EMP.TS010-K

Elektrikli Fritözler
Electric Fryers



Kod Code	Ürün Adı Description	Ebatlar Dimensions mm			Ağırlık Weight kg	Net Net m ³	Güç Power kw	Kapasite Capacity lt	Fiyatı Price Euro
		a	b	c					
EMP.6FE010	Elektrikli Fritöz Electric Fryer	400x635x285			26	0.11	7.2	10	675

Kod Code	Elektrik Girişi Electric Input	Kablo Kesiti Cable Cross Section mm ²
EMP.6FE010	400 V. AC 3N PE	5 X 2,5



Kod Code	Ürün Adı Description	Ebatlar Dimensions mm			Ağırlık Weight kg	Net Net m ³	Güç Power kw	Kapasite Capacity lt	Fiyatı Price Euro
		a	b	c					
EMP.6FE020	Elektrikli Fritöz Electric Fryer	600x635x285			42	0.17	14.4	2x10	1.200

Kod Code	Elektrik Girişi Electric Input	Kablo Kesiti Cable Cross Section mm ²
EMP.6FE020	400 V. AC 3N PE	5 X 2,5



Türkçe

ELEKTRİKLİ FRİTÖZLER

- Termostatik kontrol.
- Paslanmaz çelik sepetler.
- Hareketli ısıtıcılar kolay temizlik imkanı sağlar.
- Tahliye musluğu ile emniyetli yağ boşaltma.
- Limit termostat.
- Kolay temizlenebilir ve hijyeniktir.
- Paslanmaz çelik gövde.

English

ELECTRIC FRYERS

- Thermostatic controller.
- Stainless steel baskets.
- Moving heaters provide easy cleaning.
- Front oil drainage valve.
- Safety thermostat for overheating protection.
- Easy to clean and hygienic.
- Stainless steel body.



EMP.6FE010+EMP.TS010-K



EMP.6FE020+EMP.TS020

Elektrikli Makarna Haşlama-Patates Dinlendirme

Electric Pasta Cooker-Chips Scuttle



Kod Code	Ürün Adı Description	Ebatlar Dimensions mm			Ağırlık Weight kg	Net Net m ³	Güç Power kw	Kapasite Capacity	Fiyatı Price Euro
		a	b	c					
EMP.6ME010	Elektrikli Makarna Haşlama Electric Pasta Cooker	400x635x285			26	0.11	4.5	10 lt	825

Kod Code	Elektrik Girişi Electric Input	Kablo Kesiti Cable Cross Section mm ²
EMP.6ME010	400 V. AC 3N PE	5 X 2,5



Kod Code	Ürün Adı Description	Ebatlar Dimensions mm			Ağırlık Weight kg	Net Net m ³	Güç Power kw	Kapasite Capacity lt	Fiyatı Price Euro
		a	b	c					
EMP.6DE010	Patates Dinlendirme Chips Scuttle	400x635x285			18	0.11	0.65	GN 1/1x150 mm	350

Kod Code	Elektrik Girişi Electric Input	Kablo Kesiti Cable Cross Section mm ²
EMP.6DE010	230 V. AC N PE	3 X 1,5

Türkçe

ELEKTRİKLİ MAKARNA HAŞLAMA-PATATES DİNLENDİRME

EMP.6ME010

- Termostatik kontrol.
- Paslanmaz çelik sepetler.
- Su doldurma musluğu.
- Tahliye musluğu ile su boşaltma.
- Taşan su tahliye sistemi.
- Kolay temizlenebilir ve hijyeniktir.
- Paslanmaz çelik gövde.

EMP.6DE010

- Kızartılmış patateslerin sıcak bekletilmesinde ve yağların süzülmesinde kullanılır.
- Infrared seramik ısıtıcı.
- Havuzda kızartma yağının süzülmesi için maksimum verim sağlayan özel form.
- Kolay temizlenebilir ve hijyeniktir.
- Paslanmaz çelik gövde.

English

ELECTRIC PASTA COOKER-CHIPS SCUTTLE

EMP.6ME010

- Thermostatic controller.
- Stainless steel baskets.
- Water filling tap.
- Discharge valve.
- Overflow drainage system.
- Easy to clean and hygienic.
- Stainless steel body.

EMP.6DE010

- Operates in order to keep fries warm and drain oil.
- Infrared ceramic heater.
- Special form on the container, provides maximum efficiency in order to drain oil.
- Easy to clean and hygienic.
- Stainless steel body.

Gazlı Izgaralar
Gas Grills



Kod Code	Ürün Adı Description	Ebatlar Dimension mm			Ağırlık Weight kg	Net Net m³	Güç Power kw	Fiyatı Price Euro
		a	b	c				
EMP.6IG010	Gazlı Izgara-Düz Gas Grill-Smooth	400x635x285			47	0.11	6.3	500
EMP.6IG010-K	EMP.6IG010 İçin Krom Kaplama Farkı Chrome Coating Price Difference for EMP.6IG010							315

Kod Code	Gaz Tüketim Değeri Gas Consumption Ng	Gaz Tüketim Değeri Gas Consumption Lpg
EMP.6IG010	0,7 m³/h	0,5 kg/h

Kod Code	Ürün Adı Description	Ebatlar Dimension mm			Ağırlık Weight kg	Net Net m³	Güç Power kw	Fiyatı Price Euro
		a	b	c				
EMP.6IG020	Gazlı Izgara-Düz Gas Grill-Smooth	600x635x285			64	0.17	12.6	800
EMP.6IG022	Gazlı Izgara-Düz+Oluklu Gas Grill-Smooth+Ribbed	600x635x285			65	0.17	12.6	900
EMP.6IG020-K	EMP.6IG020 ve EMP.6IG022 İçin Krom Kaplama Farkı Chrome Coating Price Difference for EMP.6IG020 and EMP.6IG022							425

Kod Code	Gaz Tüketim Değeri Gas Consumption Ng	Gaz Tüketim Değeri Gas Consumption Lpg
EMP.6IG020	1,3 m³/h	1 kg/h
EMP.6IG022	1,3 m³/h	1 kg/h



Düz
Smooth



Düz+Oluklu
Smooth+Ribbed

Kod Code	Ürün Adı Description	Ebatlar Dimension mm			Ağırlık Weight kg	Net Net m³	Güç Power kw	Fiyatı Price Euro
		a	b	c				
EMP.6IG030	Gazlı Izgara-Düz Gas Grill-Smooth	900x635x285			83	0.24	18.9	1.100
EMP.6IG032	Gazlı Izgara-Düz+Oluklu Gas Grill-Smooth+Ribbed	900x635x285			85	0.24	18.9	1.120
EMP.6IG030-K	EMP.6IG030 ve EMP.6IG032 İçin Krom Kaplama Farkı Chrome Coating Price Difference for EMP.6IG030 and EMP.6IG032							575

Kod Code	Gaz Tüketim Değeri Gas Consumption Ng	Gaz Tüketim Değeri Gas Consumption Lpg
EMP.6IG030	2 m³/h	1,4 kg/h
EMP.6IG032	2 m³/h	1,4 kg/h



Düz
Smooth



Düz+Oluklu
Smooth+Ribbed



EMP.6IG010+EMP.TS010

EMP.6IG020+EMP.TS020-K

Türkçe

GAZLI IZGARALAR

- Lpg ve Ng ile çalışabilme özelliği.
- Magnet emniyet ventili ve pilotlu musluklar.
- Tam modüllerde iki bölge pişirme.
- Her brülör için piezzo çakmak ile kontrol.
- Çıkarılabilir yağ toplama haznesi.
- Kolay temizlenebilir ve hijyeniktir.
- Paslanmaz çelik gövde.

English

GAS GRILLS

- Lpg or Natural Gas.
- Magnet safety valves with pilot.
- Two separate heating zones.
- Piezoelectric ignition system for each module.
- Removable oil collection drawer.
- Easy to clean and hygienic.
- Stainless steel body.

Elektrikli Izgaralar
Electric Grills



Kod Code	Ürün Adı Description	Ebatlar Dimension mm			Ağırlık Weight kg	Net Net m³	Güç Power kw	Fiyatı Price Euro
		a	b	c				
EMP.61E010	Elektrikli Izgara-Düz Electric Grill-Smooth	400x635x285			49	0.11	3.6	500
EMP.61E010-K	EMP.61E010 İçin Krom Kaplama Farkı Chrome Coating Price Difference for EMP.61E010							315

Kod Code	Elektrik Girişi Electric Input	Kablo Kesiti Cable Cross Section mm²
EMP.61E010	400 V. AC 3N PE	5 X 2,5



Kod Code	Ürün Adı Description	Ebatlar Dimension mm			Ağırlık Weight kg	Net Net m³	Güç Power kw	Fiyatı Price Euro
		a	b	c				
EMP.61E020	Elektrikli Izgara-Düz Electric Grill-Smooth	600x635x285			66	0.17	7.2	800
EMP.61E022	Elektrikli Izgara-Düz+Oluklu Electric Grill-Smooth+Ribbed	600x635x285			66	0.17	7.2	900
EMP.61E020-K	EMP.61E020 ve EMP.61E022 İçin Krom Kaplama Farkı Chrome Coating Price Difference for EMP.61E020 and EMP.61E022							425

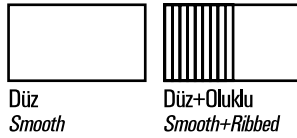

Kod Code	Elektrik Girişi Electric Input	Kablo Kesiti Cable Cross Section mm²
EMP.61E020	400 V. AC 3N PE	5 X 2,5
EMP.61E022	400 V. AC 3N PE	5 X 2,5



Kod Code	Ürün Adı Description	Ebatlar Dimension mm			Ağırlık Weight kg	Net Net m³	Güç Power kw	Fiyatı Price Euro
		a	b	c				
EMP.61E030	Elektrikli Izgara-Düz Electric Grill-Smooth	900x635x285			74	0.24	10.8	1.100
EMP.61E032	Elektrikli Izgara-Düz+Oluklu Electric Grill-Smooth+Ribbed	900x635x285			74	0.24	10.8	1.200
EMP.61E030-K	EMP.61E030 ve EMP.61E032 İçin Krom Kaplama Farkı Chrome Coating Price Difference for EMP.61E030 and EMP.61E032							575

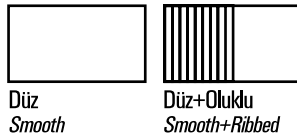

Kod Code	Elektrik Girişi Electric Input	Kablo Kesiti Cable Cross Section mm²
EMP.61E030	400 V. AC 3N PE	5 X 4
EMP.61E032	400 V. AC 3N PE	5 X 4

Türkçe

ELEKTRİKLİ IZGARALAR

- Termostatik kontrol.
- Tam modüllerde iki bölgeyi ısıtma.
- Çıkarılabilir yağ toplama haznesi.
- Kolay temizlenebilir ve hijyeniktir.
- Paslanmaz çelik gövde.

English

ELECTRIC GRILLS

- Thermostatic controller.
- Two separate heating zones.
- Removable oil collection drawer
- Easy to clean and hygienic.
- Stainless steel body.

Gazlı Lavatařlı Izgaralar Gas Lavastone Grills



Kod Code	Ürün Adı Description	Ebatlar Dimension mm			Ağırlık Weight kg	Net Net m³	Güç Power kw	Fiyatı Price Euro
		a	b	c				
EMP.6LG010	Lavatařlı Izgara - Gazlı Lavastone Grills - Gas	400x635x285			46	0.11	6.3	495

Kod Code	Gaz Tüketim Deęeri Gas Consumption Ng	Gaz Tüketim Deęeri Gas Consumption Lpg
EMP.6LG010	0,7 m³/h	0,5 kg/h



Kod Code	Ürün Adı Description	Ebatlar Dimension mm			Ağırlık Weight kg	Net Net m³	Güç Power kw	Fiyatı Price Euro
		a	b	c				
EMP.6LG020	Lavatařlı Izgara - Gazlı Lavastone Grills - Gas	600x635x285			95	0.17	12.6	765

Kod Code	Gaz Tüketim Deęeri Gas Consumption Ng	Gaz Tüketim Deęeri Gas Consumption Lpg
EMP.6LG020	1,3 m³/h	1 kg/h



Kod Code	Ürün Adı Description	Ebatlar Dimension mm			Ağırlık Weight kg	Net Net m³	Güç Power kw	Fiyatı Price Euro
		a	b	c				
EMP.6LG030	Lavatařlı Izgara - Gazlı Lavastone Grills - Gas	900x635x285			120	0.24	18.9	1.125

Kod Code	Gaz Tüketim Deęeri Gas Consumption Ng	Gaz Tüketim Deęeri Gas Consumption Lpg
EMP.6LG030	2 m³/h	1,4 kg/h



Döküm üst izgara Cast iron top



EMP.6LG020+EMP.TS020-K EMP.6LG030+EMP.TS030

Türkçe

GAZLI LAVATAŘLI IZGARALAR

- Lpg ve Ng ile çalışabilme özellięi.
- Magnet emniyet ventilli ve pilotlu musluklar.
- Tam modüllerde iki bölgeyi ısıtma.
- Her brülör için piezzo çakmak ile kontrol.
- Çıkarılabilir yağ toplama haznesi.
- Kolay temizlenebilir ve hijyeniktir.
- Paslanmaz çelik gövde.

English

GAS LAVASTONE GRILLS

- Lpg or Natural Gas.
- Magnet safety valves with pilot.
- Two separate heating zones.
- Piezoelectric ignition system for each module.
- Removable oil collection drawer.
- Easy to clean and hygienic.
- Stainless steel body.

Gazlı Sulu Izgara
Gas Vapor Grill



Kod Code	Ürün Adı Description	Ebatlar Dimension mm			Ağırlık Weight kg	Net Net m³	Güç Power kw	Fiyatı Price Euro
		a	b	c				
EMP.6LG010-S	Gazlı Sulu Izgara Gas Vapor Grill	400x730x285			45	0.11	6.5	650

Kod Code	Gaz Tüketim Değeri Gas Consumption Ng	Gaz Tüketim Değeri Gas Consumption Lpg
EMP.6LG010-S	0,7 m³/h	0,5 kg/h



Kod Code	Ürün Adı Description	Ebatlar Dimension mm			Ağırlık Weight kg	Net Net m³	Güç Power kw	Fiyatı Price Euro
		a	b	c				
EMP.6LG020-S	Gazlı Sulu Izgara Gas Vapor Grill	800x730x285			90	0.17	13	1.050

Kod Code	Gaz Tüketim Değeri Gas Consumption Ng	Gaz Tüketim Değeri Gas Consumption Lpg
EMP.6LG020-S	1,4 m³/h	1 kg/h



Kod Code	Ürün Adı Description	Ebatlar Dimension mm			Ağırlık Weight kg	Net Net m³	Güç Power kw	Fiyatı Price Euro
		a	b	c				
EMP.6LG030-S	Gazlı Sulu Izgara Gas Vapor Grill	1200x730x285			135	0.25	19.5	1.500

Kod Code	Gaz Tüketim Değeri Gas Consumption Ng	Gaz Tüketim Değeri Gas Consumption Lpg
EMP.6LG030-S	2,10 m³/h	1,57 kg/h

Türkçe

GAZLI SULU IZGARA

- Buharlaştırma kabini sayesinde daha verimli piştirme.
- Lpg ve Ng ile çalışabilme özelliği.
- Magnet emniyet ventilli ve pilotlu musluklar.
- Tam modüllerde iki bölgeyi ısıtma.
- Her brülör için piezzo çakmak ile kontrol.
- Pık döküm ızgara.
- Kolay temizlenebilir ve hijyeniktir.
- Paslanmaz çelik gövde.

English

GAS VAPOR GRILL

- Steamer cabinet provides fertile cooking.
- Lpg or Natural Gas.
- Magnet safety valves with pilot.
- Two seperate heating zones.
- Piezoelectric ignition system for each module.
- Cast iron plate.
- Easy to clean and hygienic.
- Stainless steel body.

Elektrikli Benmariler

Electric Bain maries



Kod Code	Ürün Adı Description	Ebatlar Dimension mm			Ağırlık Weight kg	Net Net m ³	Güç Power kw	Fiyatı Price Euro
		a	b	c				
EMP.6SE010	Elektrikli Benmari Electric Bain marie	400x635x285			23	0.11	1.5	450

Kod Code	Elektrik Girişi Electric Input	Kablo Kesiti Cable Cross Section mm ²
EMP.6SE010	230 V. AC N PE	3 X 1,5



Kod Code	Ürün Adı Description	Ebatlar Dimension mm			Ağırlık Weight kg	Net Net m ³	Güç Power kw	Fiyatı Price Euro
		a	b	c				
EMP.6SE020	Elektrikli Benmari Electric Bain marie	600x635x285			32	0.17	3	550

Kod Code	Elektrik Girişi Electric Input	Kablo Kesiti Cable Cross Section mm ²
EMP.6SE020	230 V. AC N PE	3 X 2,5



Türkçe

ELEKTRİKLİ BENMARİLER

- Termostatik kontrol.
- Yarım modül 1 adet GN 2/3 + 2 adet GN 1/6 kapasitelidir .
- Tam modül ise 1 adet GN 1/1 + 2 adet 1/4 kapasitelidir.
- Tahliye musluğu.
- Su alma musluğu.
- Kolay temizlenebilir ve hijyeniktir.
- Paslanmaz çelik gövde.

*Standart üretimimizde küvet bulunmamaktadır.

English

ELECTRIC BAIN MARIES

- Thermostatic controller.
- Capacity of half modul ; 1 piece of GN 2/3 + 2 pieces of GN 1/6.
- Capacity of full modul ; 1 piece of GN 1/1 + 2 pieces of 1/4.
- Drainage valve.
- Water inlet valve.
- Easy to clean and hygienic.
- Stainless steel body.

*Standart product does not have containers.

Set Altı ve Ara Tezgahlar
 Worktop and Undercounter Cabinet

Kod Code	Ürün Adı Description	Ebatlar Dimension mm			Ağırlık Weight kg	Net Net m³	Fiyatı Price Euro
		a	b	c			
EMP.6TN010	Ara Tezgah 1/2 Mod Worktop 1/2 Module	400	635	285	15	0.11	140



Kod Code	Ürün Adı Description	Ebatlar Dimension mm			Ağırlık Weight kg	Net Net m³	Fiyatı Price Euro
		a	b	c			
EMP.6TN020	Ara Tezgah / 1 Mod Worktop 1 Module	600	635	285	22	0.17	200



Kod Code	Ürün Adı Description	Ebatlar Dimension mm			Ağırlık Weight kg	Net Net m³	Fiyatı Price Euro
		a	b	c			
EMP.TS010	Set Altı Tezgah - Kapaklı Undercounter Cabinet - With Door	400	570	565	21	0.15	190



Kod Code	Ürün Adı Description	Ebatlar Dimension mm			Ağırlık Weight kg	Net Net m³	Fiyatı Price Euro
		a	b	c			
EMP.TS020	Set Altı Tezgah - Kapaklı Undercounter Cabinet - With Door	600	570	565	30	0.22	275



Kod Code	Ürün Adı Description	Ebatlar Dimension mm			Ağırlık Weight kg	Net Net m³	Fiyatı Price Euro
		a	b	c			
EMP.TS030	Set Altı Tezgah - Kapaklı Undercounter Cabinet - With Door	900	570	565	38	0.33	430

Türkçe
SET ALTI VE ARA TEZGAHLAR

- Tezgahlar 60 seri cihazların altına kullanılabilecek uygun modüler ölçülerdedir.
- Kolay temizlenebilir ve hijyeniktir.
- Paslanmaz çelik gövde.

English
WORKTOP and UNDERCOUNTER CABINET

- Under-Set Counters are suitable to use under each kind of 60's serie equipments.
- Easy to clean and hygienic.
- Stainless steel body.

Set Altı ve Ara Tezgahlar

Worktop and Undercounter Cabinet



Kod Code	Ürün Adı Description	Ebatlar Dimension mm			Ağırlık Weight kg	Net Net m³	Fiyatı Price Euro
		a	b	c			
EMP.TS010-K	Set Altı Tezgah - Kapaksız Undercounter Cabinet - Without Door	400	570	565	21	0.15	155



Kod Code	Ürün Adı Description	Ebatlar Dimension mm			Ağırlık Weight kg	Net Net m³	Fiyatı Price Euro
		a	b	c			
EMP.TS020-K	Set Altı Tezgah - Kapaksız Undercounter Cabinet - Without Door	600	570	565	30	0.22	200



Kod Code	Ürün Adı Description	Ebatlar Dimension mm			Ağırlık Weight kg	Net Net m³	Fiyatı Price Euro
		a	b	c			
EMP.TS030-K	Set Altı Tezgah - Kapaksız Undercounter Cabinet - Without Door	900	570	565	38	0.33	335





EMPERO

G|R|O|U|P

empero@empero.com.tr

700 Serisi
700 Serie



empero@empero.com.tr



Gazlı Ocaklar / Gas Cookers

Gazlı Wok Ocakları / Gas Wok Ranges

Elektrikli Ocaklar- Yuvarlak Pleyt / Electric Cookers - Circle Hot Plate

Elektrikli Ocaklar - Kare Pleyt / Electric Cookers - Square Hot Plate

Elektrikli Fritözler / Electric Fryers

Gazlı Fritözler / Gas Fryers

Elektrikli Makarna Haşlama - Patates Dinlendirme / Electric Pasta Cooker - Chips Cuttle

Gazlı Izgaralar / Gas Grills

Elektrikli Izgaralar / Electric Grills

Gazlı Lavataşlı Izgaralar / Gas Lavastone Grills

Gazlı Sulu Izgara / Gas Vapor Grill

Elektrikli Benmariler / Electric Bain maries

Ara Tezgahlar / Work Top with Cabinets

Set Altı Tezgah - Kapaklı / Undercounter Cabinet - With Door

Set Altı Tezgah - Kapaksız / Undercounter Cabinet - Without Door

Set Altı Fırınlar - Gazlı / Ovens - Gas

Set Altı Fırınlar - Elektrikli / Ovens - Electric

Devrilir Tavalalar / Tilting Pans

Kaynatma Tencereleri (İndirekt) / Boiling Pans (Indirect)

Gazlı Ocaklar
Gas Cookers



Kod Code	Ürün Adı Description	Ebatlar Dimension mm			Ağırlık Weight kg	Net Net m³	Güç Power kw	Fiyatı Price Euro
		a	b	c				
EMP.7KG010	2 Brülör'lü Gazlı Ocak 2 Burner Gas Cooker	400	730	285	24	0.8	12.6	625

Setüstü / Countertop

Kod Code	Gaz Tüketim Değeri Gas Consumption Ng	Gaz Tüketim Değeri Gas Consumption Lpg
EMP.7KG010	1,3 m³/h	1 kg/h



Kod Code	Ürün Adı Description	Ebatlar Dimension mm			Ağırlık Weight kg	Net Net m³	Güç Power kw	Fiyatı Price Euro
		a	b	c				
EMP.7KG020	4 Brülör'lü Gazlı Ocak 4 Burner Gas Cooker	800	730	285	49	0.17	25.3	1.150

Setüstü / Countertop

Kod Code	Gaz Tüketim Değeri Gas Consumption Ng	Gaz Tüketim Değeri Gas Consumption Lpg
EMP.7KG020	2,6 m³/h	1,9 kg/h



Kod Code	Ürün Adı Description	Ebatlar Dimension mm			Ağırlık Weight kg	Net Net m³	Güç Power kw	Fiyatı Price Euro
		a	b	c				
EMP.7KG030	6 Brülör'lü Gazlı Ocak 6 Burner Gas Cooker	1200	730	285	73	0.25	37.9	1.650

Setüstü / Countertop

Kod Code	Gaz Tüketim Değeri Gas Consumption Ng	Gaz Tüketim Değeri Gas Consumption Lpg
EMP.7KG030	4,0 m³/h	2,9 kg/h



Türkçe

GAZLI OCAKLAR

- Lpg ve Ng ile çalışabilme özelliği.
- Magnet emniyet ventilli musluklar.
- Darbelere karşı dayanıklı üst döküm.
- Her brülör için piezzo çakmak ile kontrol.
- Kolay temizlenebilir ve hijyeniktir.
- Paslanmaz çelik gövde.

English

GAS COOKERS

- Lpg or Natural Gas.
- Magnet safety gas valve and thermocouple.
- Heavy duty top cast iron.
- Piezoelectric ignition system for each burner.
- Easy to clean and hygienic.
- Stainless steel body.



EMP.7KG030+EMP.7FRG03



EMP.7KG020+EMP.7TS020



EMP.7KG010+EMP.7TS010-K

Gazlı Wok Ocakları
 Gas Wok Cookers

Kod Code	Ürün Adı Description	Ebatlar Dimension mm			Ağırlık Weight kg	Net Net m³	Güç Power kw	Fiyatı Price Euro
		a	b	c				
EMP.7WK010	1 Brülörlü Gazlı Wok Ocağı 1 Burner Gas Wok Cooker	400	730	285	36	0.08	18	550

Setüstü / Countertop

Kod Code	Gaz Tüketim Değeri Gas Consumption Ng	Gaz Tüketim Değeri Gas Consumption Lpg
EMP.7WK010	1,9 m³/h	1,4 kg/h



Kod Code	Ürün Adı Description	Ebatlar Dimension mm			Ağırlık Weight kg	Net Net m³	Güç Power kw	Fiyatı Price Euro
		a	b	c				
EMP.7WK020	2 Brülörlü Gazlı Wok Ocağı 2 Burner Gas Wok Cooker	800	730	285	66	0.17	2x18	950

Setüstü / Countertop

Kod Code	Gaz Tüketim Değeri Gas Consumption Ng	Gaz Tüketim Değeri Gas Consumption Lpg
EMP.7WK020	3,8 m³/h	2,8 kg/h

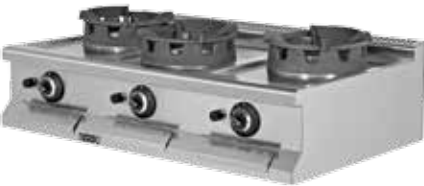

Kod Code	Ürün Adı Description	Ebatlar Dimension mm			Ağırlık Weight kg	Net Net m³	Güç Power kw	Fiyatı Price Euro
		a	b	c				
EMP.7WK030	3 Brülörlü Gazlı Wok Ocağı 3 Burner Gas Wok Cooker	1200	730	285	97	0.25	3x18	1.250

Setüstü / Countertop

Kod Code	Gaz Tüketim Değeri Gas Consumption Ng	Gaz Tüketim Değeri Gas Consumption Lpg
EMP.7WK030	5,6 m³/h	4,1 kg/h

Türkçe
GAZLI WOK OCAKLARI

- Lpg ve Ng ile çalışabilme özelliği.
- Magnet emniyet ventilli musluklar.
- Darbelere karşı dayanıklı üst döküm.
- Her brülör için piezzo çakmak ile kontrol.
- Kolay temizlenebilir ve hijyeniktir.
- Paslanmaz çelik gövde.

English
GAS WOK COOKERS

- Lpg or Natural Gas.
- Magnet safety gas valve and thermocouple.
- Heavy duty top cast iron.
- Piezoelectric ignition system for each burner.
- Easy to clean and hygienic.
- Stainless steel body.



EMP.7WK010+EMP.7TS010

EMP.7WK010+EMP.7TS010-K

Elektrikli Ocaklar- Yuvarlak Pleyt Electric Cookers - Circle Hot Plate



Kod Code	Ürün Adı Description	Ebatlar Dimension mm			Ağırlık Weight kg	Net Net m ³	Güç Power kw	Fiyatı Price Euro
		a	b	c				
EMP.7KE010	2 Pleyt'li Elektrikli Ocak 2 Hot Plate Electric Cooker	400	730	285	20	0.08	4	400

Setüstü / Countertop

Kod Code	Elektrik Girişi Electric Input	Kablo Kesiti Cable Cross Section mm ²
EMP.7KE010	200 V. AC N PE	3 X 2,5



Kod Code	Ürün Adı Description	Ebatlar Dimension mm			Ağırlık Weight kg	Net Net m ³	Güç Power kw	Fiyatı Price Euro
		a	b	c				
EMP.7KE020	4 Pleyt'li Elektrikli Ocak 4 Hot Plate Electric Cooker	800	730	285	41	0.17	8	625

Setüstü / Countertop

Kod Code	Elektrik Girişi Electric Input	Kablo Kesiti Cable Cross Section mm ²
EMP.7KE020	400 V. AC 3N PE	5 X 2,5



Kod Code	Ürün Adı Description	Ebatlar Dimension mm			Ağırlık Weight kg	Net Net m ³	Güç Power kw	Fiyatı Price Euro
		a	b	c				
EMP.7KE030	6 Pleyt'li Elektrikli Ocak 6 Hot Plate Electric Cooker	1200	730	285	84	0.25	12	990

Setüstü / Countertop

Kod Code	Elektrik Girişi Electric Input	Kablo Kesiti Cable Cross Section mm ²
EMP.7KE030	400 V. AC 3N PE	5 X 4



Türkçe

ELEKTRİKLİ OCAKLAR YUVARLAK PLEYT

- 6 kademeli şalter.
- Kolay temizlenebilir ve hijyeniktir.
- Paslanmaz çelik gövde.

English

ELECTRIC COOKERS - CIRCLE HOT PLATE

- 6 position switches
- Easy to clean and hygienic.
- Stainless steel body.



Elektrikli Ocaklar - Kare Pleyt
 Electric Cookers - Square Hot Plate

Kod Code	Ürün Adı Description	Ebatlar Dimension mm			Ağırlık Weight kg	Net Net m ³	Güç Power kw	Fiyatı Price Euro
		a	b	c				
EMP.7KE010-K	2 Pleyt'li Elektrikli Ocak 2 Hot Plate Electric Cooker	400	730	285	20	0.08	4.5	520

Setüstü / Countertop

Kod Code	Elektrik Girişi Electric Input	Kablo Kesiti Cable Cross Section mm ²
EMP.7KE010	200 V. AC N PE	3 X 2,5



Kod Code	Ürün Adı Description	Ebatlar Dimension mm			Ağırlık Weight kg	Net Net m ³	Güç Power kw	Fiyatı Price Euro
		a	b	c				
EMP.7KE020-K	4 Pleyt'li Elektrikli Ocak 4 Hot Plate Electric Cooker	800	730	285	41	0.17	9	950

Setüstü / Countertop

Kod Code	Elektrik Girişi Electric Input	Kablo Kesiti Cable Cross Section mm ²
EMP.7KE020	400 V. AC 3N PE	5 X 2,5



Kod Code	Ürün Adı Description	Ebatlar Dimension mm			Ağırlık Weight kg	Net Net m ³	Güç Power kw	Fiyatı Price Euro
		a	b	c				
EMP.7KE030-K	6 Pleyt'li Elektrikli Ocak 6 Hot Plate Electric Cooker	1200	730	285	84	0.25	13.5	1.400

Setüstü / Countertop

Kod Code	Elektrik Girişi Electric Input	Kablo Kesiti Cable Cross Section mm ²
EMP.7KE030	400 V. AC 3N PE	5 X 4

Türkçe
ELEKTRİKLİ OCAKLAR - KARE PLEYT

- 6 kademeli şalter.
- Kolay temizlenebilir ve hijyeniktir.
- Paslanmaz çelik gövde.

English
ELECTRIC COOKERS - SQUARE HOT PLATE

- 6 position switches
- Easy to clean and hygienic.
- Stainless steel body.

Elektrikli Fritözler Electric Fryers



Kod Code	Ürün Adı Description	Ebatlar Dimension mm			Ağırlık Weight kg	Net Net m³	Güç Power kw	Kapasite Capacity lt	Fiyatı Price Euro
		a	b	c					
EMP.7FE010	Elektrikli Fritöz Electric Fryer	400	730	285	23	0.08	11	18	800

Setüstü / Countertop

Kod Code	Elektrik Girişi Electric Input	Kablo Kesiti Cable Cross Section mm²
EMP.7FE010	400 V. AC 3N PE	5 X 4



Kod Code	Ürün Adı Description	Ebatlar Dimension mm			Ağırlık Weight kg	Net Net m³	Güç Power kw	Kapasite Capacity lt	Fiyatı Price Euro
		a	b	c					
EMP.7FE020	Elektrikli Fritöz Electric Fryer	800	730	285	51	0.17	22	2x18	1.415

Setüstü / Countertop

Kod Code	Elektrik Girişi Electric Input	Kablo Kesiti Cable Cross Section mm²
EMP.7FE020	400 V. AC 3N PE	5 X 4

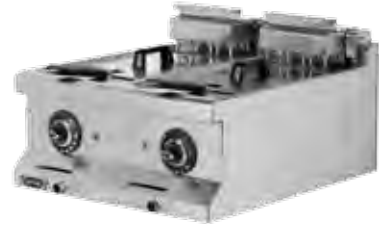

Türkçe

ELEKTRİKLİ FRİTÖZLER

- Termostatik kontrol.
- Paslanmaz çelik sepetler.
- Hareketli ısıtıcılar kolay temizlik imkanı sağlar.
- Tahliye musluğu ile emniyetli yağ boşaltma.
- Limit termostat.
- Kolay temizlenebilir ve hijyeniktir.
- Paslanmaz çelik gövde.

English

ELECTRIC FRYERS

- Thermostatic control.
- Stainless steel baskets.
- Moving heaters provide easy cleaning.
- Safe oil drainage from the bottom via valve.
- Safety thermostat for overheating protection.
- Easy to clean and hygienic.
- Stainless steel body.



Gazlı Fritözler
 Gas Fryers

Kod Code	Ürün Adı Description	Ebatlar Dimension mm			Ağırlık Weight kg	Net Net m ³	Güç Power kw	Kapasite Capacity lt	Fiyatı Price Euro
		a	b	c					
EMP.7FG010	Gazlı Fritöz Gas Fryer	400	730	850	63	0.26	11.5	18	1.050

Dolaplı / With Cupboard

Kod Code	Gaz Tüketim Değeri Gas Consumption Ng	Gaz Tüketim Değeri Gas Consumption Lpg
EMP.7FG010	1,2 m ³ /h	0,9 kg/h



Kod Code	Ürün Adı Description	Ebatlar Dimension mm			Ağırlık Weight kg	Net Net m ³	Güç Power kw	Kapasite Capacity lt	Fiyatı Price Euro
		a	b	c					
EMP.7FG020	Gazlı Fritöz Gas Fryer	800	730	850	96	0.52	23	2x18	2.000

Dolaplı / With Cupboard

Kod Code	Gaz Tüketim Değeri Gas Consumption Ng	Gaz Tüketim Değeri Gas Consumption Lpg
EMP.7FG020	2,4 m ³ /h	1,8 kg/h

Türkçe
GAZLI FRİTÖZLER

- Lpg ve Ng ile çalışabilme özelliği.
- 220 V 50 Hz çalışma voltajı.
- Termostatik kumanda.
- Paslanmaz çelik sepetler.
- Magnet emniyet ventilli musluklar.
- Boşaltma borusu ile emniyetli yağ boşaltma.
- Limit termostat.
- Kolay temizlenebilir ve hijyeniktir.
- Paslanmaz çelik gövde.

English
GAS FRYERS

- Lpg or Natural Gas
- Operating voltage: 220 V 50 Hz
- Thermostatic control.
- Stainless steel baskets.
- Magnet safety gas valve and thermocouple.
- Safe oil drainage from the bottom via valve.
- Safety thermostat for overheating protection.
- Easy to clean and hygienic.
- Stainless steel body.



Elektrikli Makarna Haşlama - Patates Dinlendirme Electric Pasta Cooker - Chips Cuttle



Kod Code	Ürün Adı Description	Ebatlar Dimension mm			Ağırlık Weight kg	Net Net m ³	Güç Power kw	Fiyatı Price Euro
		a	b	c				
EMP.7ME010	Elektrikli Makarna Haşlama Electric Pasta Cooker	400x730x285			20	0.08	10.5	975

Setüstü / Countertop

Kod Code	Gaz Tüketim Değeri Gas Consumption Ng	Gaz Tüketim Değeri Gas Consumption Lpg
EMP.7ME010	400 V. AC 3N PE	5 X 4



Kod Code	Ürün Adı Description	Ebatlar Dimension mm			Ağırlık Weight kg	Net Net m ³	Güç Power kw	Kapasite Capacity	Fiyatı Price Euro
		a	b	c					
EMP.7DE010	Patates Dinlendirme Chips Scuttle	400x730x285			15	0.26	0.08	GN 1/1X150 mm	400

Setüstü / Countertop

Kod Code	Elektrik Girişi Electric Input	Kablo Kesiti Cable Cross Section mm ²
EMP.7DE010	230 V. AC N PE	3 X 1,5



Türkçe

ELEKTRİKLİ MAKARNA HAŞLAMA

- Termostatik kontrol.
- Paslanmaz çelik sepetler.
- Su doldurma musluğu.
- Tahliye musluğu ile su boşaltma.
- Taşan su tahliye sistemi.
- Kolay temizlenebilir ve hijyeniktir.
- Paslanmaz çelik gövde.

PATATES DİNLENDİRME

- Kızartılmış patateslerin sıcak bekletilmesinde ve yağların süzülmesinde kullanılır.
- Infrared seramik ısıtıcı.
- Havuzda kızartma yağının süzülmesi için maksimum verim sağlayan özel form.
- Kolay temizlenebilir ve hijyeniktir.
- Paslanmaz çelik gövde.

English

ELECTRIC PASTA COOKER

- Thermostatic control.
- Stainless steel baskets.
- Water filling tap.
- Discharge valve.
- Overflow drainage system.
- Easy to clean and hygienic.
- Stainless steel body.

CHIPS SCUTTLE

- Operates in order to keep fries warm and drain oil.
- Infrared ceramic heater.
- Special form on the container, provides maximum efficiency in order to drain oil.
- Easy to clean and hygienic.
- Stainless steel body.



Gazlı Izgaralar
 Gas Grills

Kod Code	Ürün Adı Description	Ebatlar Dimension mm			Ağırlık Weight kg	Net Net m³	Güç Power kw	Fiyatı Price Euro
		a	b	c				
EMP.71G010	Gazlı Izgara-Düz Gas Grill-Smooth	400x730x285			40	0.08	7.2	550
EMP.71G010-K	EMP.71G010 İçin Krom Kaplama Farkı Chrome Coating Price Difference for EMP.71G010							335

Setüstü / Countertop

Kod Code	Gaz Tüketim Değeri Gas Consumption Ng	Gaz Tüketim Değeri Gas Consumption Lpg
EMP.71G010	0,8 m³/h	0,6 kg/h



Kod Code	Ürün Adı Description	Ebatlar Dimension mm			Ağırlık Weight kg	Net Net m³	Güç Power kw	Fiyatı Price Euro
		a	b	c				
EMP.71G020	Gazlı Izgara-Düz Gas Grill-Smooth	800x730x285			60	0.17	14.4	875
EMP.71G022	Gazlı Izgara-Düz+Oluklu Gas Grill-Smooth+Ribbed	800x730x285			60	0.17	14.4	950
EMP.71G020-K	EMP.71G020 ve EMP.71G022 İçin Krom Kaplama Farkı Chrome Coating Price Difference for EMP.71G020 and EMP.71G022							450

Setüstü / Countertop

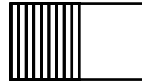
 Düz
Smooth

 Düz+Oluklu
Smooth+Ribbed

Kod Code	Gaz Tüketim Değeri Gas Consumption Ng	Gaz Tüketim Değeri Gas Consumption Lpg
EMP.71G020	1,5 m³/h	1,1 kg/h

Türkçe
GAZLI IZGARALAR

- Lpg ve Ng ile çalışabilme özelliği.
- Magnet emniyet ventilli ve pilotlu musluklar.
- Tam modüllerde iki bölgeyi ısıtma.
- Her brülör için piezo çakmak ile kontrol.
- Çıkarılabilir yağ toplama haznesi.
- Kolay temizlenebilir ve hijyeniktir.
- Paslanmaz çelik gövde.

English
GAS GRILLS

- Lpg or Natural Gas.
- Magnet safety gas valve and pilot flame.
- Two separate heating zones.
- Piezoelectric ignition system for each burner.
- Removable oil collection drawer.
- Easy to clean and hygienic.
- Stainless steel body.



EMP.71G010+EMP.7TS010



EMP.71G020+EMP.7TS020-K

Elektrikli Izgaralar
Electric Grills



Kod Code	Ürün Adı Description	Ebatlar Dimension mm			Ağırlık Weight kg	Net Net m³	Güç Power kw	Fiyatı Price Euro
		a	b	c				
EMP.71E010	Elektrikli Izgara-Düz Electric Grill-Smooth	400x730x285			45	0.08	3.6	575
EMP.71E010-K	EMP.71E010 için Krom Kaplama Farkı Chrome Coating Price Difference for EMP.71E010							335



Setüstü / Countertop

Kod Code	Gaz Tüketim Değeri Gas Consumption Ng	Gaz Tüketim Değeri Gas Consumption Lpg
EMP.71E010	400 V. AC 3N PE	5 X 2,5

Kod Code	Ürün Adı Description	Ebatlar Dimension mm			Ağırlık Weight kg	Net Net m³	Güç Power kw	Fiyatı Price Euro
		a	b	c				
EMP.71E020	Elektrikli Izgara-Düz Electric Grill-Smooth	800x730x285			70	0.17	7.2	975
EMP.71E022	Elektrikli Izgara-Düz+Oluklu Electric Grill-Smooth+Ribbed	800x730x285			70	0.17	7.2	1.050
EMP.71E020-K	EMP.71E020 ve EMP.71E022 için Krom Kaplama Farkı Chrome Coating Price Difference for EMP.71E020 and EMP.71E022							450



Setüstü / Countertop

Kod Code	Gaz Tüketim Değeri Gas Consumption Ng	Gaz Tüketim Değeri Gas Consumption Lpg
EMP.71E020	400 V. AC 3N PE	5 X 2,5

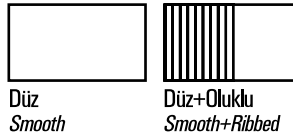

Türkçe

ELEKTRİKLİ IZGARALAR

- Termostatik kumanda.
- Tam modüllerde iki bölgeyi ısıtma.
- Çıkarılabilir yağ toplama haznesi
- Kolay temizlenebilir ve hijyeniktir.
- Paslanmaz çelik gövde.

English

ELECTRIC GRILLS

- Thermostatic control.
- Two separate heating zones.
- Removable oil collection drawer.
- Easy to clean and hygienic.
- Stainless steel body.



EMP.71E010+EMP.7TS010

EMP.71E020+EMP.7TS020-K

Gazlı Lavataşlı Izgaralar
 Gas Lavastone Grills

Kod Code	Ürün Adı Description	Ebatlar Dimension mm			Ağırlık Weight kg	Net Net m³	Güç Power kw	Fiyatı Price Euro
		a	b	c				
EMP.7LG010	Gazlı Lavataşlı Izgaralar Gas Lavastone Grills	400	730	285	45	0.08	6.7	565

Setüstü / Countertop

Kod Code	Gaz Tüketim Değeri Gas Consumption Ng	Gaz Tüketim Değeri Gas Consumption Lpg
EMP.7LG010	0,7 m³/h	0,5 kg/h



Kod Code	Ürün Adı Description	Ebatlar Dimension mm			Ağırlık Weight kg	Net Net m³	Güç Power kw	Fiyatı Price Euro
		a	b	c				
EMP.7LG020	Gazlı Lavataşlı Izgaralar Gas Lavastone Grills	800	730	285	65	0.17	13.4	930

Setüstü / Countertop

Kod Code	Gaz Tüketim Değeri Gas Consumption Ng	Gaz Tüketim Değeri Gas Consumption Lpg
EMP.7LG020	1,4 m³/h	1 kg/h

Türkçe
GAZLI LAVATAŞLI IZGARALAR

- Lpg ve Ng ile çalışabilme özelliği.
- Magnet emniyet ventilli ve pilotlu musluklar.
- Tam modüllerde iki bölgeyi ısıtma.
- Her brülör için piezo çakmak ile kontrol.
- Çıkarılabilir yağ toplama haznesi.
- Kolay temizlenebilir ve hijyeniktir.
- Paslanmaz çelik gövde.

English
GAS LAVASTONE GRILLS

- Lpg or Natural Gas.
- Safety gas valve and pilot flame.
- Two separate heating zones.
- Piezoelectric ignition system for each burner.
- Removable oil collection drawer.
- Easy to clean and hygienic.
- Stainless steel body.

Döküm üst izgara
Cast iron top

EMP.7LG020+EMP.7TS020



EMP.7LG010+EMP.7TS010-K

Gazlı Sulu Izgara Gas Vapor Grill



Kod Code	Ürün Adı Description	Ebatlar Dimension mm			Ağırlık Weight kg	Net Net m³	Güç Power kw	Fiyatı Price Euro
		a	b	c				
EMP.7LG010-S	Gazlı Sulu Izgara Gas Vapor Grill	400	730	285	50	0.08	6.5	650

Setüstü / Countertop

Kod Code	Gaz Tüketim Değeri Gas Consumption Ng	Gaz Tüketim Değeri Gas Consumption Lpg
EMP.7LG010-S	0,7 m³/h	0,5 kg/h

Kod Code	Ürün Adı Description	Ebatlar Dimension mm			Ağırlık Weight kg	Net Net m³	Güç Power kw	Fiyatı Price Euro
		a	b	c				
EMP.7LG020-S	Gazlı Sulu Izgara Gas Vapor Grill	800	730	285	90	0.17	13	1.050

Setüstü / Countertop

Kod Code	Gaz Tüketim Değeri Gas Consumption Ng	Gaz Tüketim Değeri Gas Consumption Lpg
EMP.7LG020-S	1,4 m³/h	1 kg/h

Kod Code	Ürün Adı Description	Ebatlar Dimension mm			Ağırlık Weight kg	Net Net m³	Güç Power kw	Fiyatı Price Euro
		a	b	c				
EMP.7LG030-S	Gazlı Sulu Izgara Gas Vapor Grill	1200	730	285	140	0.78	19.5	1.500

Setüstü / Countertop

Kod Code	Gaz Tüketim Değeri Gas Consumption Ng	Gaz Tüketim Değeri Gas Consumption Lpg
EMP.7LG030-S	2,10 m³/h	1,57 kg/h



Türkçe

GAZLI SULU IZGARA

- Buharlaştırma kabini sayesinde daha verimli pişirme.
- Lpg ve Ng ile çalışabilme özelliği.
- Magnet emniyet ventilli ve pilotlu musluklar.
- Tam modüllerde iki bölge ısıtma.
- Her brülör için piezo çakmak ile kontrol.
- Pık döküm ızgara.
- Kolay temizlenebilir ve hijyeniktir.
- Paslanmaz çelik gövde.

English

GAS VAPOR GRILL

- Steamer cabinet provides fertile cooking.
- Lpg or Natural Gas.
- Magnet safety gas valve and pilot flame.
- Two separate heating zones.
- Piezoelectric ignition system for each burner.
- Cast iron plate.
- Easy to clean and hygienic.
- Stainless steel body.

Elektrikli Benmariler
 Electric Bain maries

Kod Code	Ürün Adı Description	Ebatlar Dimension mm			Ağırlık Weight kg	Net Net m ³	Güç Power kw	Fiyatı Price Euro
		a	b	c				
EMP.7SE010	Elektrikli Benmari Electric Bain marie	400x730x285			15	0.08	1.5	485

Setüstü / Countertop

Kod Code	Gaz Tüketim Değeri Gas Consumption Ng	Gaz Tüketim Değeri Gas Consumption Lpg
EMP.7SE010	230 V. AC N PE	3 X 1,5



Kod Code	Ürün Adı Description	Ebatlar Dimension mm			Ağırlık Weight kg	Net Net m ³	Güç Power kw	Fiyatı Price Euro
		a	b	c				
EMP.7SE020	Elektrikli Benmari Electric Bain marie	800x730x285			33	0.17	3	850

Setüstü / Countertop

Kod Code	Gaz Tüketim Değeri Gas Consumption Ng	Gaz Tüketim Değeri Gas Consumption Lpg
EMP.7SE020	230 V. AC N PE	3 X 2,5

Türkçe
ELEKTRİKLİ BENMARİLER

- Termostatik kumanda.
- Yarım modül de 1 adet GN1/1.
- Tam modül de ise 2 adet GN1/1.
- Tahliye musluğu.
- Su alma musluğu.
- Kolay temizlenebilir ve hijyeniktir.
- Paslanmaz çelik gövde.

*Standart üretimimizde küvet bulunmamaktadır.

English
ELECTRIC BAIN MARIES

- Thermostatic control.
- Capacity of half modul ; 1 piece of GN1/1.
- Capacity of full modul ; 2 pieces of GN1/1.
- Drainage valve.
- Water inlet valve.
- Easy to clean and hygienic.
- Stainless steel body.

*Standart product does not have containers.



EMP.7SE020+EMP.7TS020



EMP.7SE010+EMP.7TS010-K

Ara Tezgahlar Work Top



Tablo/Table

Kod Code	Ürün Adı Description	Ebatlar Dimension mm			Ağırlık Weight kg	Net Net m ³	Güç Power kw	Fiyatı Price Euro
		a	b	c				
EMP.7TN010	Ara Tezgah Work Top	400	730	285	15	0.08	400	160

Setüstü / Countertop



Kod Code	Ürün Adı Description	Ebatlar Dimension mm			Ağırlık Weight kg	Net Net m ³	Güç Power kw	Fiyatı Price Euro
		a	b	c				
EMP.7TN020	Ara Tezgah Work Top	800	730	285	32	0.17	525	225

Setüstü / Countertop



Türkçe

ARA TEZGAHLAR

- Tezgah üst yüzeyleri ara ya da ön hazırlıklar için idealdir.
- Kolay temizlenebilir ve hijyeniktir.
- Paslanmaz çelik gövde.

English

WORK TOP

- Provides preliminary preparation by upper surfaces.
- Easy to clean and hygienic.
- Stainless steel body.



Set Altı Tezgah - Kapaklı
Undercounter Cabinet - With Door



Kod Code	Ürün Adı Description	Ebatlar Dimension mm			Ağırlık Weight kg	Net Net m³	Fiyatı Price Euro
		a	b	c			
EMP.7TS010	Set Altı Tezgah - Kapaklı Undercounter Cabinet - With Door	400	680	565	21	0.14	200



Kod Code	Ürün Adı Description	Ebatlar Dimension mm			Ağırlık Weight kg	Net Net m³	Fiyatı Price Euro
		a	b	c			
EMP.7TS020	Set Altı Tezgah - Kapaklı Undercounter Cabinet - With Door	800	680	565	30	0.27	285



Kod Code	Ürün Adı Description	Ebatlar Dimension mm			Ağırlık Weight kg	Net Net m³	Fiyatı Price Euro
		a	b	c			
EMP.7TS030	Set Altı Tezgah - Kapaklı Undercounter Cabinet - With Door	1200	680	565	38	0.41	450

Set Altı Tezgah - Kapaksız
Undercounter Cabinet - Without Door



Tablo/Table

Kod Code	Ürün Adı Description	Ebatlar Dimension mm			Ağırlık Weight kg	Net Net m³	Fiyatı Price Euro
		a	b	c			
EMP.7TS010-K	Set Altı Tezgah - Kapaksız Undercounter Cabinet - Without Door	400x680x565			21	0.14	165



Kod Code	Ürün Adı Description	Ebatlar Dimension mm			Ağırlık Weight kg	Net Net m³	Fiyatı Price Euro
		a	b	c			
EMP.7TS020-K	Set Altı Tezgah - Kapaksız Undercounter Cabinet - Without Door	800x680x565			30	0.27	210



Kod Code	Ürün Adı Description	Ebatlar Dimension mm			Ağırlık Weight kg	Net Net m³	Fiyatı Price Euro
		a	b	c			
EMP.7TS030-K	Set Altı Tezgah - Kapaksız Undercounter Cabinet - Without Door	1200x680x565			38	0.41	345



Set Altı Fırınlar - Gazlı
Ovens - Gas



Kod Code	Ürün Adı Description	Ebatlar Dimension mm			Ağırlık Weight kg	Net Net m ³	Güç Power kw	Fiyatı Price Euro
		a	b	c				
EMP.7FRG01	Set Altı Fırınlar - Gazlı Ovens - Gas	800	680	565	50	0.27	9	800



Kod Code	Ürün Adı Description	Ebatlar Dimension mm			Ağırlık Weight kg	Net Net m ³	Güç Power kw	Fiyatı Price Euro
		a	b	c				
EMP.7FRG02	Set Altı Fırınlar - Gazlı Ovens - Gas	1200	680	565	70	0.41	9	975



Kod Code	Ürün Adı Description	Ebatlar Dimension mm			Ağırlık Weight kg	Net Net m ³	Güç Power kw	Fiyatı Price Euro
		a	b	c				
EMP.7FRG03	Set Altı Maxi Fırınlar - Gazlı Maxi Ovens - Gas	1200	680	565	80	0.41	18	1.250

Türkçe

SET ALTI FIRINLAR - GAZLI

- Lpg ve Ng ile çalışabilme özelliği.
- 2xGN 2/1 tepsi kapasiteli paslanmaz çelik fırın iç haznesi.
- Termostatik ayarlı fırın gaz ventili.

English

OVENS - GAS

- Lpg or Natural Gas.
- 2xGN 2/1 capacity, stainless steel internal chamber.
- For oven: temperature control with thermostatic gas valve.

Set Altı Fırınlar - Elektrikli Ovens - Electric



Kod Code	Ürün Adı Description	Ebatlar Dimension mm			Ağırlık Weight kg	Net Net m³	Güç Power kw	Fiyatı Price Euro
		a	b	c				
EMP.7FRE01	Set Altı Fırınlar - Elektrikli Ovens - Electric	800	680	565	50	0.27	9	700



Kod Code	Ürün Adı Description	Ebatlar Dimension mm			Ağırlık Weight kg	Net Net m³	Güç Power kw	Fiyatı Price Euro
		a	b	c				
EMP.7FRE02	Set Altı Fırınlar - Elektrikli Ovens - Electric	1200	680	565	70	0.41	9	800



Kod Code	Ürün Adı Description	Ebatlar Dimension mm			Ağırlık Weight kg	Net Net m³	Güç Power kw	Fiyatı Price Euro
		a	b	c				
EMP.7FRE03	Set Altı Maxi Fırınlar - Elektrikli Maxi Ovens - Electric	1200	680	565	80	0.41	15	1.050



Türkçe

SET ALTI FIRINLAR - ELEKTRİKLİ

- 2xGN 2/1 tepsi kapasiteli paslanmaz çelik fırın iç haznesi.

English

OVENS - ELECTRIC

- 2xGN 2/1 capacity, stainless steel internal chamber.

Devrilir Tavalar
Tilting Pans

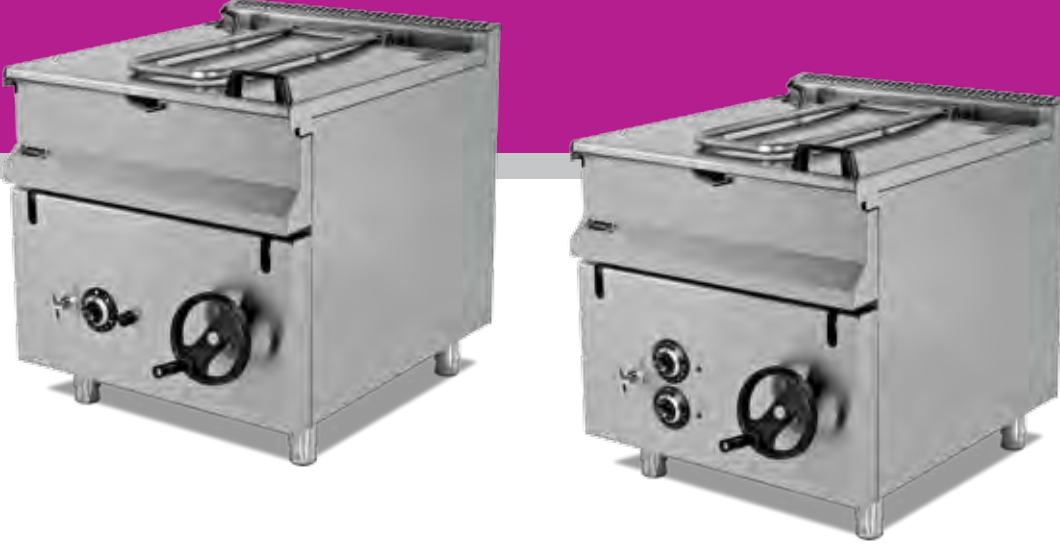

Kod Code	Ürün Adı Description	Ebatlar Dimension mm			Ağırlık Weight kg	Net Net m ³	Güç Power kw	Kapasite Capacity lt	Fiyatı Price Euro
		a	b	c					
EMP.DTG.50	Devrilir Tava (Gazlı) Tilting Pan (Gas)	800x730x850			125	0.70	8.1	50	2.250
EMP.DTE.50	Devrilir Tava (Elektrikli) Tilting Pan (Electrical)	800x730x850			138	0.70	9	50	2.250

Kod Code	Elektrik Girişi Electric Input V	Kablo Kesiti Cable Cross Section mm ²
EMP.DTE.50	380	5x4

Kod Code	Gaz Tüketim Değeri Gas Consumption Ng	Gaz Tüketim Değeri Gas Consumption Lpg
EMP.DTG.50	0,8 m ³ /h	0,6 kg/h

Türkçe

DEVİRİLİR TAVALAR (GAZLI)

- Lpg ve Ng ile çalışabilme özelliği.
- Magnet emniyet ventilli termokulp ve termostat.
- Manuel kaldırma mekanizması.
- Karşı ağırlıklı kapak.
- Güvenlik sensörü.
- Kolay temizlenebilir ve hijyeniktir.
- Paslanmaz çelik gövde.

DEVİRİLİR TAVALAR (ELEKTRİKLİ)

- Magnet emniyet ventilli termokulp ve termostat.
- Manuel kaldırma mekanizması.
- Karşı ağırlıklı kapak.
- Güvenlik sensörü.
- Kolay temizlenebilir ve hijyeniktir.
- Paslanmaz çelik gövde.

English

TILTING PANS (GAS)

- Lpg or Natural Gas.
- Safety gas valve thermocouple and thermostat.
- Manuel lift system.
- Counterweighted hinged lid.
- Safety switch.
- Easy to clean and hygienic.
- Stainless steel body.

TILTING PANS (ELECTRICAL)

- Safety valve thermocouple and thermostat.
- Manuel lift system.
- Counterweighted hinged lid.
- Safety switch.
- Easy to clean and hygienic.
- Stainless steel body.



Kaynatma Tencereleri (İndirekt)

Boiling Pans (Indirect)



Kod Code	Ürün Adı Description	Ebatlar Dimension mm			Ağırlık Weight kg	Net Net m³	Güç Power kw	Kapasite Capacity lt	Fiyatı Price Euro
		a	b	c					
EMP.KTG.70	Kaynatma Tenceresi (Gazlı) Boiling Pan (Gas)	800x730x850			112	0.70	11.5	70	3.750
EMP.KTE.70	Kaynatma Tenceresi (Elektrikli) Boiling Pan (Electrical)	800x730x850			80	0.70	12	70	3.750

Kod Code	Elektrik Girişi Electric Input V	Kablo Kesiti Cable Cross Section mm²
EMP.KTE.70	380	5x4

Kod Code	Gaz Tüketim Değeri Gas Consumption Ng	Gaz Tüketim Değeri Gas Consumption Lpg
EMP.KTG.70	1,2 m³/h	0,9 kg/h



Türkçe

KAYNATMA TENCERELERİ (GAZLI)

- Lpg ve Ng ile çalışabilme özelliği.
- Magnet emniyet ventilli termokulp ve termostat.
- Aşırı basınç valfi ve manometre.
- Soğuk, sıcak su doldurma musluğu.
- Tahliye musluğu.
- Karşı ağırlıklı kapak.
- Çift cidarlı ceket.
- Kolay temizlenebilir ve hijyeniktir.
- Paslanmaz çelik gövde.

KAYNATMA TENCERELERİ (ELEKTRİKLİ)

- Aşırı basınç valfi ve manometre.
- Soğuk, sıcak su doldurma musluğu.
- Tahliye musluğu.
- Karşı ağırlıklı kapak.
- Çift cidarlı ceket.
- Kolay temizlenebilir ve hijyeniktir.
- Paslanmaz çelik gövde.

English

BOILING PANS (GAS)

- Lpg or Natural Gas.
- Safety gas valve thermocouple and thermostat.
- Over pressure safety valve and manometer.
- Cold, hot water inlet valve.
- Drainage valve.
- Counterweighted hinged lid.
- Double jacket pan.
- Easy to clean and hygienic.
- Stainless steel body.

BOILING PANS (ELECTRICAL)

- Over pressure safety valve and manometer.
- Cold, hot water inlet valve.
- Drainage valve.
- Counterweighted hinged lid.
- Double jacket pan.
- Easy to clean and hygienic.
- Stainless steel body.



EMPERO

G|R|O|U|P

empero@empero.com.tr

700 Plus Serisi
700 Plus Serie



empero@empero.com.tr



Gazlı Ocaklar / Gas Cookers

Gazlı Wok Ocakları / Gas Wok Ranges

Elektrikli Ocaklar / Electric Cookers

Elektrikli Fritözler / Electric Fryers

Gazlı Fritözler / Gas Fryers

Elektrikli Makarna Haşlama - Patates Dinlendirme / Electric Pasta Cooker - Chips Cuttle

Gazlı Izgaralar / Gas Grills

Elektrikli Izgaralar / Electric Grills

Gazlı Sulu Izgara / Gas Vapor Grill

Gazlı Lavataşlı Izgaralar / Gas Lavastone Grills

Elektrikli Benmariler / Electric Bain maries

Ara Tezgahlar / Work Top with Cabinets

Set Altı / Worktop

Set Altı Fırınlr - Gazlı / Ovens - Gas

Set Altı Fırınlr - Elektrikli / Ovens - Electric

Devrilir Tavalr / Tilting Pans

Kaynatma Tencereleri (İndirekt) / Boiling Pans (Indirect)

Cantilever Hat / Cantilever Line

Paslanmaz Alt Bazalar / Stainless Steel Box Spring

Gazlı Ocaklar
Gas Cookers



Kod Code	Ürün Adı Description	Ebatlar Dimension mm			Ağırlık Weight kg	Net Net m³	Güç Power kw	Fiyatı Price Euro
		a	b	c				
EMP.PLS.7KG010	2 Brülör'lü Gazlı Ocak 2 Burner Gas Cooker	400	730	300	40	0.09	17	750

Setüstü / Countertop

Kod Code	Gaz Tüketim Değeri Gas Consumption Ng	Gaz Tüketim Değeri Gas Consumption Lpg
EMP.PLS.7KG010	1,8 m³/h	1,3 kg/h



Kod Code	Ürün Adı Description	Ebatlar Dimension mm			Ağırlık Weight kg	Net Net m³	Güç Power kw	Fiyatı Price Euro
		a	b	c				
EMP.PLS.7KG020	4 Brülör'lü Gazlı Ocak 4 Burner Gas Cooker	800	730	300	70	0.18	34	1.380

Setüstü / Countertop

Kod Code	Gaz Tüketim Değeri Gas Consumption Ng	Gaz Tüketim Değeri Gas Consumption Lpg
EMP.PLS.7KG020	3,5 m³/h	2,6 kg/h



Kod Code	Ürün Adı Description	Ebatlar Dimension mm			Ağırlık Weight kg	Net Net m³	Güç Power kw	Fiyatı Price Euro
		a	b	c				
EMP.PLS.7KG030	6 Brülör'lü Gazlı Ocak 6 Burner Gas Cooker	1200	730	300	90	0.26	51	1.980

Setüstü / Countertop

Kod Code	Gaz Tüketim Değeri Gas Consumption Ng	Gaz Tüketim Değeri Gas Consumption Lpg
EMP.PLS.7KG030	5,3 m³/h	3,9 kg/h



2 mm üst tabla kalınlığı
2 mm top thickness



EMP.PLS.7KG030+EMP.PLS.7FRG03

EMP.PLS.7KG020+EMP.PLS.7FRG01

EMP.PLS.7KG010+EMP.PLS.7TS010

Türkçe

GAZLI OCAKLAR

- Lpg ve Ng ile çalışabilme özelliği.
- Magnet emniyet ventilli musluklar.
- Darbelere karşı dayanıklı üst döküm.
- Her brülör için piezzo çakmak ile kontrol.
- Kolay temizlenebilir ve hijyeniktir.
- Paslanmaz çelik gövde.

English

GAS COOKERS

- Lpg or Natural Gas.
- Magnet safety gas valve and thermocouple.
- Heavy duty top cast iron.
- Piezoelectric ignition system for each burner.
- Easy to clean and hygienic.
- Stainless steel body.

Gazlı Wok Ocakları
 Gas Wok Cookers

Kod Code	Ürün Adı Description	Ebatlar Dimension mm			Ağırlık Weight kg	Net Net m ³	Güç Power kw	Fiyatı Price Euro
		a	b	c				
EMP.PLS.7WK010	1 Brülörlü Gazlı Wok Ocağı 1 Burner Gas Wok Cooker	400	730	300	37	0.09	18	660

Setüstü / Countertop

Kod Code	Gaz Tüketim Değeri Gas Consumption Ng	Gaz Tüketim Değeri Gas Consumption Lpg
EMP.PLS.7WK010	1,9 m ³ /h	1,4 kg/h



Kod Code	Ürün Adı Description	Ebatlar Dimension mm			Ağırlık Weight kg	Net Net m ³	Güç Power kw	Fiyatı Price Euro
		a	b	c				
EMP.PLS.7WK020	2 Brülörlü Gazlı Wok Ocağı 2 Burner Gas Wok Cooker	800	730	300	72	0.18	2x18	1.150

Setüstü / Countertop

Kod Code	Gaz Tüketim Değeri Gas Consumption Ng	Gaz Tüketim Değeri Gas Consumption Lpg
EMP.PLS.7WK020	3,8 m ³ /h	2,8 kg/h



Kod Code	Ürün Adı Description	Ebatlar Dimension mm			Ağırlık Weight kg	Net Net m ³	Güç Power kw	Fiyatı Price Euro
		a	b	c				
EMP.PLS.7WK030	3 Brülörlü Gazlı Wok Ocağı 3 Burner Gas Wok Cooker	1200	730	300	110	0.26	3x18	1.500

Setüstü / Countertop

Kod Code	Gaz Tüketim Değeri Gas Consumption Ng	Gaz Tüketim Değeri Gas Consumption Lpg
EMP.PLS.7WK030	5,6 m ³ /h	4,1 kg/h

Türkçe
GAZLI WOK OCAKLARI

- Lpg ve Ng ile çalışabilme özelliği.
- Magnet emniyet ventilli musluklar.
- Darbelere karşı dayanıklı üst döküm.
- Her brülör için piezzo çakmak ile kontrol.
- Kolay temizlenebilir ve hijyeniktir.
- Paslanmaz çelik gövde.

English
GAS WOK COOKERS

- Lpg or Natural Gas.
- Magnet safety gas valve and thermocouple.
- Heavy duty top cast iron.
- Piezoelectric ignition system for each burner.
- Easy to clean and hygienic.
- Stainless steel body.

2 mm üst tabla kalınlığı
2 mm top thickness

EMP.PLS.7WK010+EMP.PLS.7TS010

EMP.PLS.7WK020+EMP.PLS.7TS020

Elektrikli Ocakları
Electric Cookers



Kod Code	Ürün Adı Description	Ebatlar Dimension mm			Ağırlık Weight kg	Net Net m ³	Güç Power kw	Fiyatı Price Euro
		a	b	c				
EMP.PLS.7KE010	2 Pleyt'li Elektrikli Ocak 2 Hot Plate Electric Cooker	400	730	300	37	0.09	4.5	625

Setüstü / Countertop

Kod Code	Elektrik Girişi Electric Input	Kablo Kesiti Cable Cross Section mm ²
EMP.PLS.7KE010	200 V. AC N PE	3 X 2,5



Kod Code	Ürün Adı Description	Ebatlar Dimension mm			Ağırlık Weight kg	Net Net m ³	Güç Power kw	Fiyatı Price Euro
		a	b	c				
EMP.PLS.7KE020	4 Pleyt'li Elektrikli Ocak 4 Hot Plate Electric Cooker	800	730	300	65	0.18	9	1.150

Setüstü / Countertop

Kod Code	Elektrik Girişi Electric Input	Kablo Kesiti Cable Cross Section mm ²
EMP.PLS.7KE020	400 V. AC 3N PE	5 X 2,5



Kod Code	Ürün Adı Description	Ebatlar Dimension mm			Ağırlık Weight kg	Net Net m ³	Güç Power kw	Fiyatı Price Euro
		a	b	c				
EMP.PLS.7KE030	6 Pleyt'li Elektrikli Ocak 6 Hot Plate Electric Cooker	1200	730	300	84	0.26	13.5	1.700

Setüstü / Countertop

Kod Code	Elektrik Girişi Electric Input	Kablo Kesiti Cable Cross Section mm ²
EMP.PLS.7KE030	400 V. AC 3N PE	5 X 4



2 mm üst tabla kalınlığı
2 mm top thickness

Türkçe

ELEKTRİKLİ OCAKLARI

- 6 kademeli şalter.
- Kolay temizlenebilir ve hijyeniktir.
- Paslanmaz çelik gövde.

English

ELECTRIC COOKERS

- 6 position switches.
- Easy to clean and hygienic.
- Stainless steel body.



EMP.PLS.7KE030+EMP.PLS.7FRE020

EMP.PLS.7KE020+EMP.PLS.7TS020

EMP.PLS.7KE010+EMP.PLS.7TS010

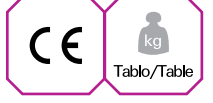
Elektrikli Fritözler
 Electric Fryers

Kod Code	Ürün Adı Description	Ebatlar Dimension mm			Ağırlık Weight kg	Net Net m ³	Güç Power kw	Kapasite Capacity lt	Fiyatı Price Euro
		a	b	c					
EMP.PLS.7FE010	Elektrikli Fritöz Electric Fryer	400	730	850	65	0.09	12	18	1.200

Dolaplı / With Cupboard

Kod Code	Elektrik Girişi Electric Input	Kablo Kesiti Cable Cross Section mm ²
EMP.PLS.7FE010	400 V. AC 3N PE	5 X 4

Kod Code	Ürün Adı Description	Ebatlar Dimension mm			Ağırlık Weight kg	Net Net m ³	Güç Power kw	Kapasite Capacity lt	Fiyatı Price Euro
		a	b	c					
EMP.PLS.7FE020	Elektrikli Fritöz Electric Fryer	800	730	850	110	0.18	24	2x18	2.050

Dolaplı / With Cupboard

Kod Code	Elektrik Girişi Electric Input	Kablo Kesiti Cable Cross Section mm ²
EMP.PLS.7FE020	400 V. AC 3N PE	5 X 4

Türkçe
ELEKTRİKLİ FRİTÖZLER

- Termostatik kontrol.
- Paslanmaz çelik sepetler.
- Hareketli ısıtıcılar kolay temizlik imkanı sağlar.
- Tahliye musluğu ile emniyetli yağ boşaltma.
- Limit termostat.
- Kolay temizlenebilir ve hijyeniktir.
- Paslanmaz çelik gövde.

2 mm üst tabla kalınlığı
2 mm top thickness
English
ELECTRIC FRYERS

- Thermostatic control.
- Stainless steel baskets.
- Moving heaters provide easy cleaning.
- Safe oil drainage from the bottom via valve.
- Safety thermostat for overheating protection.
- Easy to clean and hygienic.
- Stainless steel body.



Gazlı Fritözler
Gas Fryers



Kod Code	Ürün Adı Description	Ebatlar Dimension mm			Ağırlık Weight kg	Net Net m³	Güç Power kw	Kapasite Capacity lt	Fiyatı Price Euro
		a	b	c					
EMP.PLS.7FG010	Gazlı Fritöz Gas Fryer	400	730	850	70	0.26	10.5	18	1.350

Dolaplı / With Cupboard

Kod Code	Gaz Tüketim Değeri Gas Consumption Ng	Gaz Tüketim Değeri Gas Consumption Lpg
EMP.PLS.7FG010	1,1 m³/h	0,8 kg/h

Kod Code	Ürün Adı Description	Ebatlar Dimension mm			Ağırlık Weight kg	Net Net m³	Güç Power kw	Kapasite Capacity lt	Fiyatı Price Euro
		a	b	c					
EMP.PLS.7FG020	Gazlı Fritöz Gas Fryer	800	730	850	130	0.52	21	2x18	2.250

Dolaplı / With Cupboard

Kod Code	Gaz Tüketim Değeri Gas Consumption Ng	Gaz Tüketim Değeri Gas Consumption Lpg
EMP.PLS.7FG020	2,2 m³/h	1,6 kg/h



2 mm üst tabla kalınlığı
2 mm top thickness

Türkçe

GAZLI FRİTÖZLER

- Lpg ve Ng ile çalışabilme özelliği.
- 220 V 50 Hz. çalışma voltajı.
- Termostatik kumanda.
- Paslanmaz çelik sepetler.
- Magnet emniyet ventilli musluklar.
- Boşaltma borusu ile emniyetli yağ boşaltma.
- Limit termostat.
- Kolay temizlenebilir ve hijyeniktir.
- Paslanmaz çelik gövde.

English

GAS FRYERS

- Lpg or Natural Gas.
- Operating voltage: 220 V 50 Hz.
- Thermostatic control.
- Stainless steel baskets.
- Magnet safety gas valve and thermocouple.
- Safe oil drainage from the bottom via valve.
- Safety thermostat for overheating protection.
- Easy to clean and hygienic.
- Stainless steel body.



Elektrikli Makarna Haşlama - Patates Dinlendirme

Electric Pasta Cooker - Chips Scuttle



Kod Code	Ürün Adı Description	Ebatlar Dimension mm			Ağırlık Weight kg	Net Net m³	Güç Power kw	Kapasite Capacity lt	Fiyatı Price Euro
		a	b	c					
EMP.PLS.7ME010	Elektrikli Makarna Haşlama Electric Pasta Cooker	400x730x850			60	0.09	10.5	10.5	1.400

Dolaplı / With Cupboard

Kod Code	Elektrik Girişi Electric Input	Kablo Kesiti Cable Cross Section mm²
EMP.PLS.7ME010	400 V. AC 3N PE	5 X 4



Kod Code	Ürün Adı Description	Ebatlar Dimension mm			Ağırlık Weight kg	Net Net m³	Güç Power kw	Kapasite Capacity lt	Fiyatı Price Euro
		a	b	c					
EMP.PLS.7DE010	Patates Dinlendirme Chips Scuttle	400x730x300			39	0.09	0.65	GN 1/1X150 mm	480

Setüstü / Countertop

Kod Code	Elektrik Girişi Electric Input	Kablo Kesiti Cable Cross Section mm²
EMP.PLS.7DE010	230 V. AC N PE	3 X 1,5

2 mm üst tabla kalınlığı
2 mm top thickness

Türkçe

ELEKTRİKLİ MAKARNA HAŞLAMA

- Termostatik kontrol.
- Paslanmaz çelik sepetler.
- Su doldurma musluğu.
- Tahliye musluğu ile su boşaltma.
- Taşan su tahliye sistemi.
- Kolay temizlenebilir ve hijyeniktir.
- Paslanmaz çelik gövde.

PATATES DİNLENDİRME

- Kızartılmış patateslerin sıcak bekletilmesinde ve yağların süzülmesinde kullanılır.
- Infrared seramik ısıtıcı.
- Havuzda kızartma yağının süzülmesi için maksimum verim sağlayan özel form.
- Kolay temizlenebilir ve hijyeniktir.
- Paslanmaz çelik gövde.

English

ELECTRIC PASTA COOKER

- Thermostatic control.
- Stainless steel baskets.
- Water filling tap.
- Discharge valve.
- Overflow drainage system.
- Easy to clean and hygienic.
- Stainless steel body.

CHIPS SCUTTLE

- Operates in order to keep fries warm and drain oil.
- Infrared ceramic heater.
- Special form on the container, provides maximum efficiency in order to drain oil.
- Easy to clean and hygienic.
- Stainless steel body.



EMP.PLS.7DE010+EMP.PLS.7TS010

Gazlı Izgaralar
Gas Grills



Kod Code	Ürün Adı Description	Ebatlar Dimension mm			Ağırlık Weight kg	Net Net m³	Güç Power kw	Fiyatı Price Euro
		a	b	c				
EMP.PLS.7IG010	Gazlı Izgara-Düz Gas Grill-Smooth	400	730	300	45	0.09	9	1.050

Setüstü / Countertop

Kod Code	Gaz Tüketim Değeri Gas Consumption Ng	Gaz Tüketim Değeri Gas Consumption Lpg
EMP.PLS.7IG010	0,9 m³/h	0,7 kg/h



Kod Code	Ürün Adı Description	Ebatlar Dimension mm			Ağırlık Weight kg	Net Net m³	Güç Power kw	Fiyatı Price Euro
		a	b	c				
EMP.PLS.7IG020	Gazlı Izgara-Düz Gas Grill-Smooth	800	730	300	90	0.18	18	1.600
EMP.PLS.7IG022	Gazlı Izgara-Düz+Oluklu Gas Grill- Smooth+Ribbed	800	730	300	92	0.18	18	1.700

Setüstü / Countertop

Kod Code	Gaz Tüketim Değeri Gas Consumption Ng	Gaz Tüketim Değeri Gas Consumption Lpg
EMP.PLS.7IG020	1,9 m³/h	1,4 kg/h
EMP.PLS.7IG022	1,9 m³/h	1,4 kg/h



2 mm üst tabla kalınlığı
2 mm top thickness



EMP.PLS.7IG020+EMP.PLS.7TS020 EMP.PLS.7IG010+EMP.PLS.7TS010

Türkçe

GAZLI IZGARALAR

- Lpg ve Ng ile çalışabilme özelliği.
- Magnet emniyet ventilli ve pilotlu musluklar.
- Tam modüllerde iki bölge ısıtma.
- Her brülör için piezo çakmak ile kontrol.
- Çıkarılabilir yağ toplama haznesi.
- Kolay temizlenebilir ve hijyeniktir.
- Paslanmaz çelik gövde.

Krom Tablalı
Chrome Plate

English

GAS GRILLS

- Lpg or Natural Gas.
- Magnet safety gas valve and pilot flame.
- Two separate heating zones.
- Piezoelectric ignition system for each burner.
- Removable oil collection drawer.
- Easy to clean and hygienic.
- Stainless steel body.

Elektrikli Izgaralar
Electric Grills



Kod Code	Ürün Adı Description	Ebatlar Dimension mm			Ağırlık Weight kg	Net Net m ³	Güç Power kw	Fiyatı Price Euro
		a	b	c				
EMP.PLS.71E010	Elektrikli Izgara-Düz Electric Grill-Smooth	400	730	300	47	0.09	4.2	1.050

Setüstü / Countertop

Kod Code	Gaz Tüketim Değeri Gas Consumption Ng	Gaz Tüketim Değeri Gas Consumption Lpg
EMP.PLS.71E010	400 V. AC 3N PE	5 X 2,5



Kod Code	Ürün Adı Description	Ebatlar Dimension mm			Ağırlık Weight kg	Net Net m ³	Güç Power kw	Fiyatı Price Euro
		a	b	c				
EMP.PLS.71E020	Elektrikli Izgara-Düz Electric Grill-Smooth	800	730	300	92	0.18	8.4	1.700
EMP.PLS.71E022	Elektrikli Izgara-Düz+Oluklu Electric Grill-Smooth+Ribbed	800	730	300	95	0.18	8.4	1.800

Setüstü / Countertop

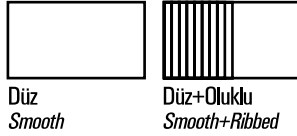

Kod Code	Gaz Tüketim Değeri Gas Consumption Ng	Gaz Tüketim Değeri Gas Consumption Lpg
EMP.PLS.71E020	400 V. AC 3N PE	5 X 2,5
EMP.PLS.71E022	400 V. AC 3N PE	5 X 2,5

2 mm üst tabla kalınlığı
2 mm top thickness

Krom Tablalı
Chrome Plate



EMP.PLS.71E020+EMP.PLS.7TS020

EMP.PLS.71E010+EMP.PLS.7TS010

Türkçe

ELEKTRİKLİ IZGARALAR

- Termostatik kumanda.
- Tam modüllerde iki bölgeyi ısıtma.
- Çıkarılabilir yağ toplama haznesi
- Kolay temizlenebilir ve hijyeniktir.
- Paslanmaz çelik gövde.

English

ELECTRIC GRILLS

- Thermostatic control.
- Two separate heating zones.
- Removable oil collection drawer.
- Easy to clean and hygienic.
- Stainless steel body.

Gazlı Sulu Izgara
Gas Vapor Grill



Kod Code	Ürün Adı Description	Ebatlar Dimension mm			Ağırlık Weight kg	Net Net m³	Güç Power kw	Fiyatı Price Euro
		a	b	c				
EMP.PLS.7LG010-S	Gazlı Sulu Izgara Gas Vapor Grill	400	730	300	45	0.09	7	750

Setüstü / Countertop

Kod Code	Gaz Tüketim Değeri Gas Consumption Ng	Gaz Tüketim Değeri Gas Consumption Lpg
EMP.PLS.7LG010-S	0,72 m³/h	0,53 kg/h



Kod Code	Ürün Adı Description	Ebatlar Dimension mm			Ağırlık Weight kg	Net Net m³	Güç Power kw	Fiyatı Price Euro
		a	b	c				
EMP.PLS.7LG020-S	Gazlı Sulu Izgara Gas Vapor Grill	800	730	300	90	0.18	14	1.250

Setüstü / Countertop

Kod Code	Gaz Tüketim Değeri Gas Consumption Ng	Gaz Tüketim Değeri Gas Consumption Lpg
EMP.PLS.7LG020-S	1,5 m³/h	1,1 kg/h



Kod Code	Ürün Adı Description	Ebatlar Dimension mm			Ağırlık Weight kg	Net Net m³	Güç Power kw	Fiyatı Price Euro
		a	b	c				
EMP.PLS.7LG030-S	Gazlı Sulu Izgara Gas Vapor Grill	1200	730	300	135	0.26	21	1.700

Setüstü / Countertop

Kod Code	Gaz Tüketim Değeri Gas Consumption Ng	Gaz Tüketim Değeri Gas Consumption Lpg
EMP.PLS.7LG030-S	2,2 m³/h	1,6 kg/h



EMP.PLS.7LG030-S+EMP.PLS.7TS030

2 mm üst tabla kalınlığı
2 mm top thickness

Türkçe

GAZLI SULU IZGARA

- Buharlaştırma kabini sayesinde daha verimli pişirme.
- Lpg ve Ng ile çalışabilme özelliği.
- Magnet emniyet ventilli ve pilotlu musluklar.
- Tam modüllerde iki bölgeyi ısıtma.
- Her brülör için piezo çakmak ile kontrol.
- Pısk döküm ızgara.
- Kolay temizlenebilir ve hijyeniktir.
- Paslanmaz çelik gövde.

English

GAS VAPOR GRILL

- Steamer cabinet provides fertile cooking.
- Lpg or Natural Gas.
- Magnet safety gas valve and pilot flame .
- Two separate heating zones .
- Piezoelectric ignition system for each burner.
- Cast iron plate.
- Easy to clean and hygienic.
- Stainless steel body.

Gazlı Lavataşlı Izgaralar
 Gas Lavastone Grills

Kod Code	Ürün Adı Description	Ebatlar Dimension mm			Ağırlık Weight kg	Net Net m ³	Güç Power kw	Fiyatı Price Euro
		a	b	c				
EMP.PLS.7LG010	Lavataşlı Izgara - Gazlı Lavastone Grills - Gas	400	730	300	68	0.09	6	675

Setüstü / Countertop

Kod Code	Gaz Tüketim Değeri Gas Consumption Ng	Gaz Tüketim Değeri Gas Consumption Lpg
EMP.PLS.7LG010	0,6 m ³ /h	0,5 kg/h



Kod Code	Ürün Adı Description	Ebatlar Dimension mm			Ağırlık Weight kg	Net Net m ³	Güç Power kw	Fiyatı Price Euro
		a	b	c				
EMP.PLS.7LG020	Lavataşlı Izgara - Gazlı Lavastone Grills - Gas	800	730	300	107	0.18	12	1.100

Setüstü / Countertop

Kod Code	Gaz Tüketim Değeri Gas Consumption Ng	Gaz Tüketim Değeri Gas Consumption Lpg
EMP.PLS.7LG020	1,3 m ³ /h	0,9 kg/h

2 mm üst tabla kalınlığı
2 mm top thickness
Türkçe
GAZLI LAVATAŞLI IZGARALAR

- Lpg ve Ng ile çalışabilme özelliği.
- Magnet emniyet ventilli ve pilotlu musluklar.
- Tam modüllerde iki bölgeyi ısıtma.
- Her brülör için piezo çakmak ile kontrol.
- Çıkarılabilir yağ toplama haznesi.
- Kolay temizlenebilir ve hijyeniktir.
- Paslanmaz çelik gövde.

English
GAS LAVASTONE GRILLS

- Lpg or Natural Gas.
- Safety gas valve and pilot flame.
- Two separate heating zones.
- Piezoelectric ignition system for each burner.
- Removable oil collection drawer.
- Easy to clean and hygienic.
- Stainless steel body.

Döküm üst ızgara
Cast iron top

EMP.PLS.7LG020+EMP.PLS.7TS020 EMP.PLS.7LG010+EMP.PLS.7TS010

Elektrikli Benmariler
Electric Bain maries



Kod Code	Ürün Adı Description	Ebatlar Dimension mm			Ağırlık Weight kg	Net Net m³	Güç Power kw	Fiyatı Price Euro
		a	b	c				
EMP.PLS.7SE010	Elektrikli Benmari Electric Bain marie	400	730	850	65	0.09	1.5	825

Dolaplı / With Cupboard

Kod Code	Elektrik Girişi Electric Input	Kablo Kesiti Cable Cross Section mm²
EMP.PLS.7SE010	230 V. AC N PE	3 X 1,5

Kod Code	Ürün Adı Description	Ebatlar Dimension mm			Ağırlık Weight kg	Net Net m³	Güç Power kw	Fiyatı Price Euro
		a	b	c				
EMP.PLS.7SE020	Elektrikli Benmari Electric Bain marie	800	730	850	115	0.18	3	1.350

Dolaplı / With Cupboard

Kod Code	Elektrik Girişi Electric Input	Kablo Kesiti Cable Cross Section mm²
EMP.PLS.7SE020	230 V. AC N PE	3 X 2,5

2 mm üst tabla kalınlığı
2 mm top thickness



Türkçe

ELEKTRİKLİ BENMARİLER

- Termostatik kumanda.
- Yarım modül de 1 adet GN1/1.
- Tam modül de ise 2 adet GN1/1.
- Tahliye musluğu.
- Su alma musluğu.
- Kolay temizlenebilir ve hijyeniktir.
- Paslanmaz çelik gövde.

*Standart üretimimizde kuvvet bulunmamaktadır.

English

ELECTRIC BAIN MARIES

- Thermostatic control.
- Capacity of half modul ; 1 piece of GN1/1.
- Capacity of full modul ; 2 pieces of GN1/1.
- Drainage valve.
- Water inlet valve.
- Easy to clean and hygienic.
- Stainless steel body.

*Standart product does not have containers.

Ara Tezgahlar
Undercounter Cabinet



Kod Code	Ürün Adı Description	Ebatlar Dimension mm			Ağırlık Weight kg	Net Net m³	Fiyatı Price Euro
		a	b	c			
EMP.PLS.7TN010	Ara Tezgah 1/2 Mod Worktop 1/2 Module	400x730x300			17	0.09	240

Setüstü / Countertop



Kod Code	Ürün Adı Description	Ebatlar Dimension mm			Ağırlık Weight kg	Net Net m³	Fiyatı Price Euro
		a	b	c			
EMP.PLS.7TN020	Ara Tezgah / 1 Mod Worktop 1 Module	800x730x300			30	0.18	380

Setüstü / Countertop

2 mm üst tabla kalınlığı
2 mm top thickness

Türkçe

ARA TEZGAHLAR

- Tezgahlar 60 seri cihazların altına kullanılabilecek uygun modüler ölçülerdedir.
- Kolay temizlenebilir ve hijyeniktir.
- Paslanmaz çelik gövde.

English

UNDERCOUNTER CABINET

- Under-Set Counters are suitable to use under each kind of 60's serie equipments.
- Easy to clean and hygienic.
- Stainless steel body.



EMP.PLS.7TN020+EMP.PLS.7TS020



EMP.PLS.7TN010+EMP.PLS.7TS010

Set Altı
Worktop



Kod Code	Ürün Adı Description	Ebatlar Dimension mm			Ağırlık Weight kg	Net Net m³	Fiyatı Price Euro
		a	b	c			
EMP.PLS.7TS010	Set Altı Tezgah Undercounter Cabinet	400	620	550	21	0.09	300



Kod Code	Ürün Adı Description	Ebatlar Dimension mm			Ağırlık Weight kg	Net Net m³	Fiyatı Price Euro
		a	b	c			
EMP.PLS.7TS020	Set Altı Tezgah Undercounter Cabinet	800	620	550	30	0.18	450



Kod Code	Ürün Adı Description	Ebatlar Dimension mm			Ağırlık Weight kg	Net Net m³	Fiyatı Price Euro
		a	b	c			
EMP.PLS.7TS030	Set Altı Tezgah Undercounter Cabinet	1200	620	550	38	0.26	700

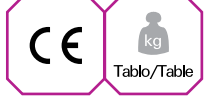

Set Altı Fırınlar - Gazlı
 Ovens - Gas

Kod Code	Ürün Adı Description	Ebatlar Dimension mm			Ağırlık Weight kg	Net Net m³	Güç Power kw	Fiyatı Price Euro
		a	b	c				
EMP.PLS.7FRG01	Set Altı Fırınlar - Gazlı Ovens - Gas	800	620	550	60	0.27	9	880



Kod Code	Ürün Adı Description	Ebatlar Dimension mm			Ağırlık Weight kg	Net Net m³	Güç Power kw	Fiyatı Price Euro
		a	b	c				
EMP.PLS.7FRG02	Set Altı Fırınlar - Gazlı Ovens - Gas	1200	620	550	80	0.41	9	1.075



Kod Code	Ürün Adı Description	Ebatlar Dimension mm			Ağırlık Weight kg	Net Net m³	Güç Power kw	Fiyatı Price Euro
		a	b	c				
EMP.PLS.7FRG03	Set Altı Maxi Fırınlar - Gazlı Maxi Ovens - Gas	1200	620	550	90	0.41	18	1.375

Türkçe
SET ALTI FIRINLAR - GAZLI

- Lpg ve Ng ile çalışabilme özelliği.
- 2xGN 2/1 tepsi kapasiteli paslanmaz çelik fırın iç haznesi.
- Termostatik ayarlı fırın gaz ventili.

English
OVENS - GAS

- Lpg or Natural Gas
- 2xGN 2/1 capacity, stainless steel internal chamber.
- For oven: temperature control with thermostatic gas valve.

Set Altı Fırınlar - Elektrikli
Ovens - Electric



Kod Code	Ürün Adı Description	Ebatlar Dimension mm			Ağırlık Weight kg	Net Net m³	Güç Power kw	Fiyatı Price Euro
		a	b	c				
EMP.PLS.7FRE01	Set Altı Fırınlar - Elektrikli Ovens - Electric	800	620	550	60	0.27	9	770



Kod Code	Ürün Adı Description	Ebatlar Dimension mm			Ağırlık Weight kg	Net Net m³	Güç Power kw	Fiyatı Price Euro
		a	b	c				
EMP.PLS.7FRE02	Set Altı Fırınlar - Elektrikli Ovens - Electric	1200	620	550	80	0.41	9	880



Kod Code	Ürün Adı Description	Ebatlar Dimension mm			Ağırlık Weight kg	Net Net m³	Güç Power kw	Fiyatı Price Euro
		a	b	c				
EMP.PLS.7FRE03	Set Altı Maxi Fırınlar - Elektrikli Maxi Ovens - Electric	1200	620	550	90	0.41	15	1.155



Türkçe

SET ALTI FIRINLAR - ELEKTRİKLİ

- 2xGN 2/1 tepsi kapasiteli paslanmaz çelik fırın iç haznesi.

English

OVENS - ELECTRIC

- 2xGN 2/1 capacity, stainless steel internal chamber.

Devrilir Tavalar
Tilting Pans



Kod Code	Ürün Adı Description	Ebatlar Dimension mm			Ağırlık Weight kg	Net Net m³	Güç Power kw	Kapasite Capacity lt	Fiyatı Price Euro
		a	b	c					
EMP.PLS.DTG.50	Devrilir Tava (Gazlı) Tilting Pan (Gas)	800x730x850			125	0.70	13	50	2.475
EMP.PLS.DTE.50	Devrilir Tava (Elektrikli) Tilting Pan (Electrical)	800x730x850			138	0.70	9	50	2.475

Kod Code	Elektrik Girişi Electric Input V	Kablo Kesiti Cable Cross Section mm²
EMP.PLS.DTE.50	380	5x4

Kod Code	Gaz Tüketim Değeri Gas Consumption Ng	Gaz Tüketim Değeri Gas Consumption Lpg
EMP.PLS.DTG.50	0,4 m³/h	0,3 kg/h

Türkçe

DEVİRİLİR TAVALAR (GAZLI)

- Lpg ve Ng ile çalışabilme özelliği.
- Magnet emniyet ventilli termokulp ve termostat.
- Manuel kaldırma mekanizması.
- Karşı ağırlıklı kapak.
- Güvenlik sensörü.
- Kolay temizlenebilir ve hijyeniktir.
- Paslanmaz çelik gövde.

DEVİRİLİR TAVALAR (ELEKTRİKLİ)

- Magnet emniyet ventilli termokulp ve termostat.
- Manuel kaldırma mekanizması.
- Karşı ağırlıklı kapak.
- Güvenlik sensörü.
- Kolay temizlenebilir ve hijyeniktir.
- Paslanmaz çelik gövde.

English

TILTING PANS (GAS)

- Lpg or Natural Gas.
- Safety gas valve thermocouple and thermostat.
- Manuel lift system.
- Counterweighted hinged lid.
- Safety switch.
- Easy to clean and hygienic.
- Stainless steel body.

TILTING PANS (ELECTRICAL)

- Safety valve thermocouple and thermostat.
- Manuel lift system.
- Counterweighted hinged lid.
- Safety switch.
- Easy to clean and hygienic.
- Stainless steel body.

Kaynatma Tencereleri (İndirekt)
Boiling Pans (Indirect)



Kod Code	Ürün Adı Description	Ebatlar Dimension mm			Ağırlık Weight kg	Net Net m³	Güç Power kw	Kapasite Capacity lt	Fiyatı Price Euro
		a	b	c					
EMP.PLS.KTG.70	Kaynatma Tenceresi (Gazlı) Boiling Pan (Gas)	800x730x850			112	0.70	15	70	4.125
EMP.PLS.KTE.70	Kaynatma Tenceresi (Elektrikli) Boiling Pan (Electrical)	800x730x850			80	0.70	12	70	4.125

Kod Code	Elektrik Girişi Electric Input v	Kablo Kesiti Cable Cross Section mm²
EMP.PLS.KTE.70	380	5x4

Kod Code	Gaz Tüketim Değeri Gas Consumption Ng	Gaz Tüketim Değeri Gas Consumption Lpg
EMP.PLS.KTG.70	0,64 m³/h	0,48 kg/h



Türkçe

KAYNATMA TENCERELERİ (GAZLI)

- Lpg ve Ng ile çalışabilme özelliği.
- Magnet emniyet ventilli termokulp ve termostat.
- Aşırı basınç valfi ve manometre.
- Soğuk, sıcak su doldurma musluğu.
- Tahliye musluğu.
- Karşı ağırlıklı kapak.
- Çift cidarlı ceket.
- Kolay temizlenebilir ve hijyeniktir.
- Paslanmaz çelik gövde.

KAYNATMA TENCERELERİ (ELEKTRİKLİ)

- Aşırı basınç valfi ve manometre.
- Soğuk, sıcak su doldurma musluğu.
- Tahliye musluğu.
- Karşı ağırlıklı kapak.
- Çift cidarlı ceket.
- Kolay temizlenebilir ve hijyeniktir.
- Paslanmaz çelik gövde.

English

BOILING PANS (GAS)

- Lpg or Natural Gas.
- Safety gas valve thermocouple and thermostat.
- Over pressure safety valve and manometer.
- Cold, hot water inlet valve.
- Drainage valve.
- Counterweighted hinged lid.
- Double jacket pan.
- Easy to clean and hygienic.
- Stainless steel body.

BOILING PANS (ELECTRICAL)

- Over pressure safety valve and manometer.
- Cold, hot water inlet valve.
- Drainage valve.
- Counterweighted hinged lid.
- Double jacket pan.
- Easy to clean and hygienic.
- Stainless steel body.

Cantilever Hat
Cantilever Line

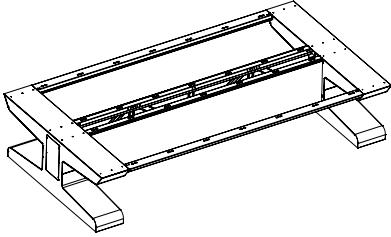

Kod Code	Ürün Adı Description	Ebatlar Dimension mm			Fiyatı Price Euro
		a	b	c	
EMP.PLS.7CTV240	Cantilever Hat Cantilever Line	2400	1370	550	3.240

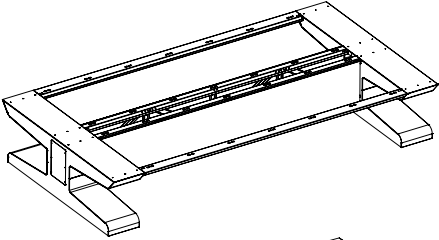

Kod Code	Ürün Adı Description	Ebatlar Dimension mm			Fiyatı Price Euro
		a	b	c	
EMP.PLS.7CTV280	Cantilever Hat Cantilever Line	2800	1370	550	3.950

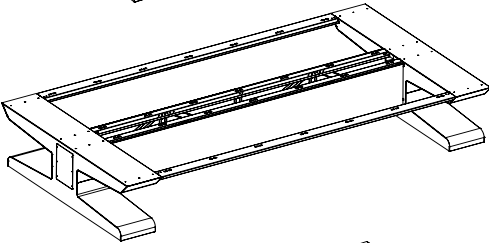

Kod Code	Ürün Adı Description	Ebatlar Dimension mm			Fiyatı Price Euro
		a	b	c	
EMP.PLS.7CTV320	Cantilever Hat Cantilever Line	3200	1370	550	4.320

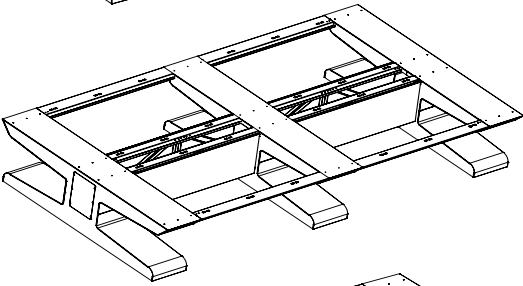

Kod Code	Ürün Adı Description	Ebatlar Dimension mm			Fiyatı Price Euro
		a	b	c	
EMP.PLS.7CTV360	Cantilever Hat Cantilever Line	3600	1370	550	5.040

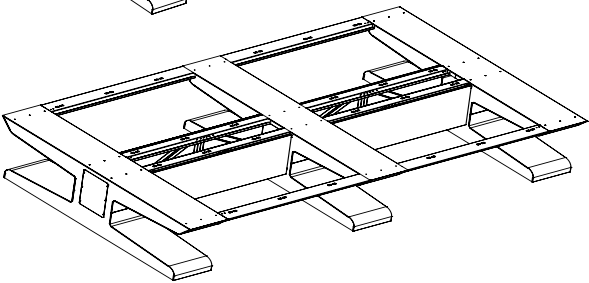

Kod Code	Ürün Adı Description	Ebatlar Dimension mm			Fiyatı Price Euro
		a	b	c	
EMP.PLS.7CTV400	Cantilever Hat Cantilever Line	4000	1370	550	5.400

Gazlı fritözler, Elektrikli fritözler, Elektrikli Benmariler, Elektrikli Makarna Haşlamalar ürünlerinde ALT KISIM dolaplı olarak gelmektedir.

For Gas Fryers , Electrical Fryers , Electrical Bainmaries and Electrical Pasta Cookers BOTTOM SIDE includes Cabinet.

Paslanmaz Alt Bazalar
Stainless Steel Box Spring



Tablo/Table

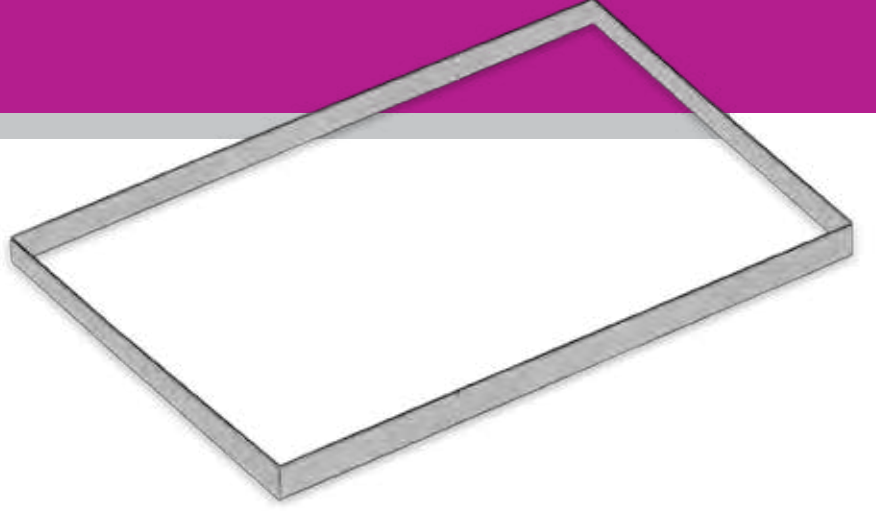

Kod Code	Ürün Adı Description	Fiyatı Price Euro
EMP.PLS.7SBP240	Paslanmaz Alt Bazalar - 240 cm Stainless Steel Box Spring - 240 cm	500

Kod Code	Ürün Adı Description	Fiyatı Price Euro
EMP.PLS.7SBP280	Paslanmaz Alt Bazalar - 280 cm Stainless Steel Box Spring - 280 cm	600

Kod Code	Ürün Adı Description	Fiyatı Price Euro
EMP.PLS.7SBP320	Paslanmaz Alt Bazalar - 320 cm Stainless Steel Box Spring - 320 cm	700

Kod Code	Ürün Adı Description	Fiyatı Price Euro
EMP.PLS.7SBP360	Paslanmaz Alt Bazalar - 360 cm Stainless Steel Box Spring - 360 cm	800

Kod Code	Ürün Adı Description	Fiyatı Price Euro
EMP.PLS.7SBP400	Paslanmaz Alt Bazalar - 400 cm Stainless Steel Box Spring - 400 cm	900



EMPERO

GROUP

empero@empero.com.tr

900 Serisi
900 Serie



empero@empero.com.tr



Gazlı Kuzineler Fırınlı / Gas Ranges with Oven

Yer Ocakları / Single Ranges

Yer Ocakları 4 Yanışlı / Single Ranges- 4 Ring

Gazlı Ocaklar / Gas Cookers

Gazlı Ocaklar / Gas Cookers

Gazlı Wok Ocakları / Gas Wok Ranges

Elektrikli Ocaklar / Electric Cookers

Elektrikli Fritözler / Electric Fryers

Gazlı Fritözler / Gas Fryers

Elektrikli Makarna Haşlama - Patates Dinlendirme / Electric Pasta Cooker - Chips Cuttle

Gazlı Izgaralar / Gas Grills

Elektrikli Izgaralar / Electric Grills

Gazlı Lavataşlı Izgaralar / Gas Lavastone Grills

Gazlı Sulu Izgara / Gas Vapor Grill

Elektrikli Benmariler / Electric Bain maries

Ara Tezgahlar / Work Top with Cabinets

Set Altı Tezgah - Kapaklı / Undercounter Cabinet - With Door

Set Altı Tezgah - Kapaksız / Undercounter Cabinet - Without Door

Set Altı Fırınlar - Gazlı / Ovens - Gas

Set Altı Fırınlar - Elektrikli / Ovens - Electric

Kaynatma Tencereleri (İndirekt) / Boiling Pans (Indirect)

Devrilir Tavalar / Tilting Pans

Gazlı Kuzineler - Fırınlı
Gas Ranges with Oven



Kod Code	Ürün Adı Description	Ebatlar Dimension mm			Ağırlık Weight kg	Net Net m³	Güç Power kw	Fiyatı Price Euro
		a	b	c				
EMP.9KG.021	4 Brülör'lü Fırınlı Gazlı Kuzine-Ventilli 4 Burner Gas Range-With Oven,Valve	1000x1000x850			155	0.85	37.3	1.300
EMP.K2.100	4 Brülör'lü Fırınlı Gazlı Kuzine-Ventilsiz 4 Burner Gas Range-With Oven,Without Valve	1000x1000x850			130	0.85	40	1.150

Kod Code	Gaz Tüketim Değeri Gas Consumption Ng	Gaz Tüketim Değeri Gas Consumption Lpg
EMP.K2.100	-	3,75 kg/h
EMP.9KG.021	5 m³/h	-

Kontrol Paneli
Control Panel



Türkçe

GAZLI KUZINELER - FIRINLI

- Lpg ve Ng ile çalışabilme özelliği.
- 2xGN 2/1 tepsi kapasiteli paslanmaz çelik fırın haznesi.
- Magnet emniyet ventilli musluklar.
- Darbelere karşı dayanıklı üst döküm.
- Kolay temizlenebilir ve hijyeniktir.
- Paslanmaz çelik gövde.

English

GAS RANGES WITH OVEN

- Lpg or Natural Gas.
- 2xGN 2/1 capacity, stainless steel internal chamber.
- Magnet safety valves.
- Heavy duty top cast iron.
- Easy to clean and hygienic.
- Stainless steel body.

Emniyet ventili olmayan gazlı kuzineler açık havada kullanılmak üzere üretilmiştir. Kapalı alanda kullanılamaz.
Gas Ranges without safety valve produced in intent to operate outdoor. Do not operate indoor.

Yer Ocakları
Single Ranges



Kod Code	Ürün Adı Description	Ebatlar Dimension mm			Ağırlık Weight kg	Net Net m ³	Güç Power kw	Fiyatı Price Euro
		a	b	c				
EMP.YRG.50	Yer Ocağı-Ventilsiz Gas Stock Pot Stove-Without Valve	600	800	500	60	0.24	9.3	450

Kod Code	Gaz Tüketim Değeri Gas Consumption Ng	Gaz Tüketim Değeri Gas Consumption Lpg
EMP.YRG.50	-	0,7 kg/h



Kod Code	Ürün Adı Description	Ebatlar Dimension mm			Ağırlık Weight kg	Net Net m ³	Güç Power kw	Fiyatı Price Euro
		a	b	c				
EMP.YRG.60	Yer Ocağı-Ventilli Gas Stock Pot Stove-With Valve	600	800	500	60	0.24	9.3	500

Kod Code	Gaz Tüketim Değeri Gas Consumption Ng	Gaz Tüketim Değeri Gas Consumption Lpg
EMP.YRG.60	1 m ³ /h	-



Kod Code	Ürün Adı Description	Ebatlar Dimension mm			Ağırlık Weight kg	Net Net m ³	Güç Power kw	Fiyatı Price Euro
		a	b	c				
EMP.YRE.60	Elektrikli Yer Ocağı Electric Stock Pot Stove	600	800	500	60	0.24	4	600

Kod Code	Elektrik Girişi Electric Input V	Kablo Kesiti Cable Cross Section mm ²
EMP.YRE.60	220-380	3x2.5

Türkçe

YER OCAKLARI

- Lpg ve Ng ile çalışabilme özelliği.
- Magnet emniyet ventilli musluklar.
- Darbelere karşı dayanıklı üst döküm.
- Kolay temizlenebilir ve hijyeniktir.
- Paslanmaz çelik gövde.

English

SINGLE RANGES

- Lpg or Natural Gas.
- Magnet safety valves.
- Heavy duty top cast iron.
- Easy to clean and hygienic.
- Stainless steel body.

Emniyet ventili olmayan yer ocakları açık havada kullanılmak üzere üretilmiştir. Kapalı alanda kullanılamaz.
Gas Stock Pot Stove without safety valve produced in intent to operate outdoor. Do not operate indoor.

Yer Ocakları - 4 Yanıřlı
Single Ranges - 4 Ring



Kod Code	Ürün Adı Description	Ebatlar Dimension mm			Ağırlık Weight kg	Net Net m³	Güç Power kw	Fiyatı Price Euro
		a	b	c				
EMP.YRG.70	Yer Ocağı 4 Yanıřlı-Ventilsiz 4 Ring Stock Pot Stove-Without	700x800x500			80	0.28	32	650

Kod Code	Gaz Tüketim Değeri Gas Consumption Ng	Gaz Tüketim Değeri Gas Consumption Lpg
EMP.YRG.70	-	2,4 kg/h



Kod Code	Ürün Adı Description	Ebatlar Dimension mm			Ağırlık Weight kg	Net Net m³	Güç Power kw	Fiyatı Price Euro
		a	b	c				
EMP.YRG.80	Yer Ocağı 4 Yanıřlı-Ventilli 4 Ring Stock Pot Stove-With Valve	700x800x500			80	0.28	32	750

Kod Code	Gaz Tüketim Değeri Gas Consumption Ng	Gaz Tüketim Değeri Gas Consumption Lpg
EMP.YRG.80	3,3 m³/h	-



4 YANIřLI BRULÖR
4 RING HIGH POWER BURNER

Türkçe

YER OCAKLARI 4 YANIřLI

- Lpg ve Ng ile çalışabilme özelliđi.
- Magnet emniyet ventilli musluklar.
- Darbelere karşı dayanıklı üst döküm.
- Kolay temizlenebilir ve hijyeniktir.
- Paslanmaz çelik gövde.

Emniyet ventili olmayan yer ocakları açık havada kullanılmak üzere üretilmiştir. Kapalı alanda kullanılamaz. Gas Stock Pot Stove without safety valve produced in intent to operate outdoor. Do not operate indoor.

English

SINGLE RANGES - 4 RING

- Lpg or Natural Gas.
- Magnet safety valves.
- Heavy duty top cast iron.
- Easy to clean and hygienic.
- Stainless steel body.

GAZLI OCAKLAR
Gas Cookers



Kod Code	Ürün Adı Description	Ebatlar Dimension mm			Ağırlık Weight kg	Net Net m ³	Güç Power kw	Fiyatı Price Euro
		a	b	c				
EMP.9KG010	2 Brülör'lü Gazlı Ocak 2 Burner Gas Cooker	400	900	285	35	0.10	15.2	720

Setüstü / C countertop

Kod Code	Gaz Tüketim Değeri Gas Consumption Ng	Gaz Tüketim Değeri Gas Consumption Lpg
EMP.9KG010	1,6 m ³ /h	1,2 kg/h



Kod Code	Ürün Adı Description	Ebatlar Dimension mm			Ağırlık Weight kg	Net Net m ³	Güç Power kw	Fiyatı Price Euro
		a	b	c				
EMP.9KG020	4 Brülör'lü Gazlı Ocak 4 Burner Gas Cooker	800	900	285	65	0.21	30.4	1.325

Setüstü / C countertop

Kod Code	Gaz Tüketim Değeri Gas Consumption Ng	Gaz Tüketim Değeri Gas Consumption Lpg
EMP.9KG020	3,2 m ³ /h	2,3 kg/h

Türkçe

GAZLI OCAKLAR

- Lpg ve Ng ile çalışabilme özelliği.
- Magnet emniyet ventilli musluklar.
- Darbelere karşı dayanıklı üst döküm.
- Her brülör için piezzo çakmak ile kontrol.
- Kolay temizlenebilir ve hijyeniktir.
- Paslanmaz çelik gövde.

English

GAS COOKERS

- Lpg or Natural Gas.
- Magnet safety valves.
- Heavy duty top cast iron.
- Piezoelectric ignition system for each burner.
- Easy to clean and hygienic.
- Stainless steel body.



EMP.9KG020+EMP.9FRG020



EMP.9KG020+EMP.9TS020



EMP.9KG010+EMP.9TS010-K

Gazlı Ocaklar
Gas Cookers



Kod Code	Ürün Adı Description	Ebatlar Dimension mm			Ağırlık Weight kg	Net Net m³	Güç Power kw	Fiyatı Price Euro
		a	b	c				
EMP.9KG030	6 Brülör'lü Gazlı Ocak 6 Burner Gas Cooker	1200	900	285	92	0.31	45.6	1.900

Setüstü / Countertop

Kod Code	Gaz Tüketim Değeri Gas Consumption Ng	Gaz Tüketim Değeri Gas Consumption Lpg
EMP.9KG030	4,8 m³/h	3,5 kg/h



Kod Code	Ürün Adı Description	Ebatlar Dimension mm			Ağırlık Weight kg	Net Net m³	Güç Power kw	Fiyatı Price Euro
		a	b	c				
EMP.9YRG80	4 Yanışlı Ocak 4 Ring Cooker	800	900	285	70	0.21	32	1.050

Setüstü / Countertop

Kod Code	Gaz Tüketim Değeri Gas Consumption Ng	Gaz Tüketim Değeri Gas Consumption Lpg
EMP.9YRG80	3,3 m³/h	2,4 kg/h



4 YANIŞLI BRULÖR
4 RING HIGH POWER BURNER

Türkçe

GAZLI OCAKLAR

- Lpg ve Ng ile çalışabilme özelliği.
- Magnet emniyet ventilli musluklar.
- Darbelere karşı dayanıklı üst döküm.
- Her brülör için piezzo çakmak ile kontrol.
- Kolay temizlenebilir ve hijyeniktir.
- Paslanmaz çelik gövde.

English

GAS COOKERS

- Lpg or Natural Gas.
- Magnet safety valves.
- Heavy duty top cast iron.
- Piezoelectric ignition system for each burner.
- Easy to clean and hygienic.
- Stainless steel body.



EMP.9KG030+EMP.9FRG03



EMP.9YRG80+EMP.9TS020

Gaslı Wok Ocakları
 Gas Wok Cookers

Kod Code	Ürün Adı Description	Ebatlar Dimension mm			Ağırlık Weight kg	Net Net m³	Güç Power kw	Fiyatı Price Euro
		a	b	c				
EMP.9WK010	1 Brülörlü Gazlı Wok Ocağı 1 Burner Gas Wok Cooker	400	900	285	35	0.10	18	635

Setüstü / Countertop

Kod Code	Gaz Tüketim Değeri Gas Consumption Ng	Gaz Tüketim Değeri Gas Consumption Lpg
EMP.9WK010	1,9 m³/h	1,4 kg/h



Kod Code	Ürün Adı Description	Ebatlar Dimension mm			Ağırlık Weight kg	Net Net m³	Güç Power kw	Fiyatı Price Euro
		a	b	c				
EMP.9WK020	2 Brülörlü Gazlı Wok Ocağı 2 Burner Gas Wok Cooker	800	900	285	71	0.21	2x18	1.090

Setüstü / Countertop

Kod Code	Gaz Tüketim Değeri Gas Consumption Ng	Gaz Tüketim Değeri Gas Consumption Lpg
EMP.9WK020	3,8 m³/h	2,8 kg/h

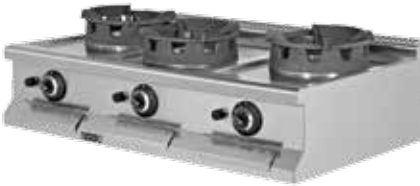

Kod Code	Ürün Adı Description	Ebatlar Dimension mm			Ağırlık Weight kg	Net Net m³	Güç Power kw	Fiyatı Price Euro
		a	b	c				
EMP.9WK030	3 Brülörlü Gazlı Wok Ocağı 3 Burner Gas Wok Cooker	1200	900	285	105	0.31	3x18	1.450

Setüstü / Countertop

Kod Code	Gaz Tüketim Değeri Gas Consumption Ng	Gaz Tüketim Değeri Gas Consumption Lpg
EMP.9WK030	5,6 m³/h	4,1 kg/h

Türkçe
GAZLI WOK OCAKLARI

- Lpg ve Ng ile çalışabilme özelliği.
- Magnet emniyet ventilli musluklar.
- Darbelere karşı dayanıklı üst döküm.
- Her brülör için piezzo çakmak ile kontrol.
- Kolay temizlenebilir ve hijyeniktir.
- Paslanmaz çelik gövde.

English
GAS WOK COOKERS

- Lpg or Natural Gas.
- Magnet safety gas valve and thermocouple.
- Heavy duty top cast iron.
- Piezoelectric ignition system for each burner.
- Easy to clean and hygienic.
- Stainless steel body.



EMP.9WK010+EMP.9TS010 EMP.9WK010+EMP.9TS010-K

Elektrikli Ocaklar
Electric Cookers

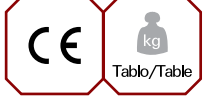

Kod Code	Ürün Adı Description	Ebatlar Dimension mm			Ağırlık Weight kg	Net Net m³	Güç Power kw	Fiyatı Price Euro
		a	b	c				
EMP.9KE010	2 Pleytli Elektrikli Ocak 2 Hot Plate Electric Cooker	400x900x285			32	0.10	8	820



Setüstü / Countertop

Kod Code	Elektrik Girişi Electric Input	Kablo Kesiti Cable Cross Section mm²
EMP.9KE010	400 V. AC 3N PE	5 X 2,5

Kod Code	Ürün Adı Description	Ebatlar Dimension mm			Ağırlık Weight kg	Net Net m³	Güç Power kw	Fiyatı Price Euro
		a	b	c				
EMP.9KE020	4 Pleytli Elektrikli Ocak 4 Hot Plate Electric Cooker	800x900x285			75	0.21	16	1.375



Setüstü / Countertop

Kod Code	Elektrik Girişi Electric Input	Kablo Kesiti Cable Cross Section mm²
EMP.9KE020	400 V. AC 3N PE	5 X 4

Kod Code	Ürün Adı Description	Ebatlar Dimension mm			Ağırlık Weight kg	Net Net m³	Güç Power kw	Fiyatı Price Euro
		a	b	c				
EMP.9KE030	6 Pleytli Elektrikli Ocak 6 Hot Plate Electric Cooker	1200x900x285			122	0.31	24	2.185



Setüstü / Countertop

Kod Code	Elektrik Girişi Electric Input	Kablo Kesiti Cable Cross Section mm²
EMP.9KE030	400 V. AC 3N PE	5 X 6

Türkçe

ELEKTRİKLİ OCAKLAR

- 6 kademeli şalter.
- Kolay temizlenebilir ve hijyeniktir.
- Paslanmaz çelik gövde.

English

ELECTRIC COOKERS

- 6 position switch.
- Easy to clean and hygienic.
- Stainless steel body.



EMP.9KE020+EMP.9TS020-K

EMP.9KE010+EMP.9TS010

EMP.9KE030+EMP.9FRE02

Elektrikli Fritözler Electric Fryers



Kod Code	Ürün Adı Description	Ebatlar Dimension mm			Ağırlık Weight kg	Net Net m³	Güç Power kw	Kapasite Capacity lt	Fiyatı Price Euro
		a	b	c					
EMP.9FE010	Elektrikli Fritöz Electric Fryer	400	900	850	61	0.10	12	24	1.150

Dolaplı / With Cupboard

Kod Code	Elektrik Girişi Electric Input	Kablo Kesiti Cable Cross Section mm²
EMP.9FE010	400 V. AC 3N PE	5 X 4



Kod Code	Ürün Adı Description	Ebatlar Dimension mm			Ağırlık Weight kg	Net Net m³	Güç Power kw	Kapasite Capacity lt	Fiyatı Price Euro
		a	b	c					
EMP.9FE020	Elektrikli Fritöz Electric Fryer	800	900	850	138	0.21	24	2X24	1.955

Dolaplı / With Cupboard

Kod Code	Elektrik Girişi Electric Input	Kablo Kesiti Cable Cross Section mm²
EMP.9FE020	400 V. AC 3N PE	5 X 6



Kod Code	Ürün Adı Description	Ebatlar Dimension mm			Ağırlık Weight kg	Net Net m³	Güç Power kw	Kapasite Capacity lt	Fiyatı Price Euro
		a	b	c					
EMP.9FE010-K	Elektrikli Fritöz Electric Fryer	400	900	850	51	0.10	12	24	1.115

Dolaplı / With Cupboard

Kod Code	Elektrik Girişi Electric Input	Kablo Kesiti Cable Cross Section mm²
EMP.9FE010-K	400 V. AC 3N PE	5 X 4



Kod Code	Ürün Adı Description	Ebatlar Dimension mm			Ağırlık Weight kg	Net Net m³	Güç Power kw	Kapasite Capacity lt	Fiyatı Price Euro
		a	b	c					
EMP.9FE020-K	Elektrikli Fritöz Electric Fryer	800	900	850	128	0.21	24	2X24	1.885

Dolaplı / With Cupboard

Kod Code	Elektrik Girişi Electric Input	Kablo Kesiti Cable Cross Section mm²
EMP.9FE020-K	400 V. AC 3N PE	5 X 6

Türkçe

ELEKTRİKLİ FRİTÖZLER

- Termostatik kumanda.
- Paslanmaz çelik sepetler.
- Hareketli ısıtıcılar kolay temizlik imkanı sağlar.
- Boşaltma borusu ile emniyetli yağ boşaltma.
- Limit termostat.
- Kolay temizlenebilir ve hijyeniktir.
- Paslanmaz çelik gövde.

English

ELECTRIC FRYERS

- Thermostatic control.
- Stainless steel baskets.
- Moving heaters provide easy cleaning.
- Safe oil drainage from the bottom via valve.
- Safety thermostat for overheating protection.
- Easy to clean and hygienic.
- Stainless steel body.

Gazlı Fritözler
Gas Fryers

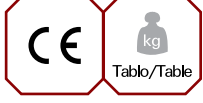

Kod Code	Ürün Adı Description	Ebatlar Dimension mm			Ağırlık Weight kg	Net Net m³	Güç Power kw	Kapasite Capacity lt	Fiyatı Price Euro
		a	b	c					
EMP.9FG010	Gazlı Fritöz Gas Fryer	400	900	850	80	0.31	15.3	24	1.250

Dolaplı / With Cupboard

Kod Code	Gaz Tüketim Değeri Gas Consumption Ng	Gaz Tüketim Değeri Gas Consumption Lpg
EMP.9FG010	1,6 m³/h	1,2 kg/h



Kod Code	Ürün Adı Description	Ebatlar Dimension mm			Ağırlık Weight kg	Net Net m³	Güç Power kw	Kapasite Capacity lt	Fiyatı Price Euro
		a	b	c					
EMP.9FG020	Gazlı Fritöz Gas Fryer	800	900	850	138	0.62	30.6	2X24	2.155

Dolaplı / With Cupboard

Kod Code	Gaz Tüketim Değeri Gas Consumption Ng	Gaz Tüketim Değeri Gas Consumption Lpg
EMP.9FG020	3,2 m³/h	2,3 kg/h



Türkçe

GAZLI FRİTÖZLER

- Lpg ve Ng ile çalışabilme özelliği.
- 220 V 50 Hz. çalışma voltajı.
- Termostatik kumanda.
- Paslanmaz çelik sepetler.
- Magnet emniyet ventilli musluklar.
- Boşaltma borusu ile emniyetli yağ boşaltma.
- Limit termostat.
- Kolay temizlenebilir ve hijyeniktir.
- Paslanmaz çelik gövde.

English

GAS FRYERS

- Lpg or Ng.
- Operating voltage: 220V 50 Hz
- Thermostatic control.
- Stainless steel baskets.
- Magnet safety gas valve and thermocouple.
- Safe oil drainage from the bottom via valve.
- Safety thermostat for overheating protection.
- Easy to clean and hygienic.
- Stainless steel body.

Elektrikli Makarna Haşlama - Patates Dinlendirme

Electric Pasta Cooker - Chips Scuttle



Kod Code	Ürün Adı Description	Ebatlar Dimension mm			Ağırlık Weight kg	Net Net m ³	Güç Power kw	Fiyatı Price Euro
		a	b	c				
EMP.9ME010	Elektrikli Makarna Haşlama Electric Pasta Cooker	400	900	850	60	0.10	12	1.350

Dolaplı / With Cupboard

Kod Code	Elektrik Girişi Electric Input	Kablo Kesiti Cable Cross Section mm ²
EMP.9ME010	400 V. AC 3N PE	5 X 4



Kod Code	Ürün Adı Description	Ebatlar Dimension mm			Ağırlık Weight kg	Net Net m ³	Güç Power kw	Fiyatı Price Euro
		a	b	c				
EMP.9ME010-K	Elektrikli Makarna Haşlama Electric Pasta Cooker	400	900	850	60	0.10	12	1.315

Dolaplı / With Cupboard

Kod Code	Elektrik Girişi Electric Input	Kablo Kesiti Cable Cross Section mm ²
EMP.9ME010-K	400 V. AC 3N PE	5 X 4



Kod Code	Ürün Adı Description	Ebatlar Dimension mm			Ağırlık Weight kg	Net Net m ³	Güç Power kw	Fiyatı Price Euro
		a	b	c				
EMP.9DE010	Patates Dinlendirme Chips Scuttle	400	900	285	20	0.10	0.65	460

Setüstü / Countertop

Kod Code	Elektrik Girişi Electric Input	Kablo Kesiti Cable Cross Section mm ²
EMP.9DE010	230 V. AC N PE	3 X 1,5

Türkçe

ELEKTRİKLİ MAKARNA HAŞLAMA

- Termostatik kontrol.
- Paslanmaz çelik sepetler.
- Su doldurma musluğu.
- Tahliye musluğu ile su boşaltma .
- Taşan su tahliye sistemi.
- Kolay temizlenebilir ve hijyeniktir.
- Paslanmaz çelik gövde.

PATATES DİNLENDİRME

- Kızartılmış patateslerin sıcak bekletilmesinde ve yağların süzülmesinde kullanılır.
- GN 1/1X150 mm küvet kapasitesi.
- Infrared seramik ısıtıcı.
- Havuzda kızartma yağının süzülmesi için maksimum verim sağlayan özel form.
- Kolay temizlenebilir ve hijyeniktir.
- Paslanmaz çelik gövde.

English

ELECTRIC PASTA COOKER

- Thermostatic control.
- Stainless steel baskets.
- Water filling tap.
- Discharge valve.
- Overflow drainage system.
- Easy to clean and hygienic.
- Stainless steel body.

CHIPS SCUTTLE

- Operates in order to keep fried food warm and drain oil.
- Capacity: GN 1/1X150 mm
- Ceramic infrared heater.
- Special form on the container, provides maximum efficiency in order to drain oil.
- Easy to clean and hygienic.
- Stainless steel body.



EMP.7DE010+EMP.7TS010

Gazlı Izgaralar
Gas Grills

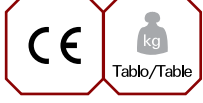

Kod Code	Ürün Adı Description	Ebatlar Dimension mm			Ağırlık Weight kg	Net Net m³	Güç Power kw	Fiyatı Price Euro
		a	b	c				
EMP.9IG010	Gazlı Izgara-Düz Gas Grill-Smooth	400x900x285			65	0.10	9.3	635
EMP.9IG010-K	EMP.9IG010 İçin Krom Kaplama Farkı Chrome Coating Price Difference for EMP.9IG010							365



Setüstü / Countertop

Kod Code	Elektrik Girişi Electric Input	Kablo Kesiti Cable Cross Section mm²
EMP.9IG010	1,0 m³/h	0,7 kg/h

Kod Code	Ürün Adı Description	Ebatlar Dimension mm			Ağırlık Weight kg	Net Net m³	Güç Power kw	Fiyatı Price Euro
		a	b	c				
EMP.9IG020	Gazlı Izgara-Düz Gas Grill-Smooth	800x900x285			106	0.21	18.6	1.000
EMP.9IG022	Gazlı Izgara-Düz+Oluklu Gas Grill-Smooth+Ribbed	800x900x285			108	0.21	18.6	1.100
EMP.9IG020-K	EMP.9IG020 ve EMP.9IG022 İçin Krom Kaplama Farkı Chrome Coating Price Difference for EMP.9IG020 and EMP.9IG022							475



Setüstü / Countertop

Kod Code	Gaz Tüketim Değeri Gas Consumption Ng	Gaz Tüketim Değeri Gas Consumption Lpg
EMP.9IG020	1,9 m³/h	1,4 kg/h
EMP.9IG022	1,9 m³/h	1,4 kg/h

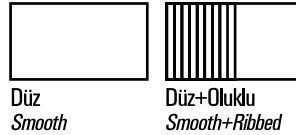

EMP.9IG010+EMP.9TS010

EMP.9IG020+EMP.9TS020-K

Türkçe

GAZLI IZGARALAR

- Lpg ve Ng ile çalışabilme özelliği.
- Magnet emniyet ventilli ve pilotlu musluklar.
- Tam modüllerde iki bölge ısıtma.
- Her brülör için piezzo çakmak ile kontrol.
- Çıkarılabilir yağ toplama haznesi.
- Kolay temizlenebilir ve hijyeniktir.
- Paslanmaz çelik gövde.

English

GAS GRILLS

- Lpg or Natural Gas.
- Magnet safety gas valve and pilot flame.
- Two separate heating zones.
- Piezoelectric ignition system for each burner.
- Removable oil collecting drawer.
- Easy to clean and hygienic.
- Stainless steel body.

Elektrikli Izgaralar
 Electric Grills



Kod Code	Ürün Adı Description	Ebatlar Dimension mm			Ağırlık Weight kg	Net Net m³	Güç Power kw	Fiyatı Price Euro
		a	b	c				
EMP.9IE010	Elektrikli Izgara-Düz Electric Grill-Smooth	400x900x285			65	0.10	6	660
EMP.9IE010-K	EMP.9IE010 için Krom Kaplama Farkı Chrome Coating Price Difference for EMP.9IE010							365

Setüstü / Countertop

Kod Code	Elektrik Girişi Electric Input	Kablo Kesiti Cable Cross Section mm²
EMP.9IE010	400 V. AC 3N PE	5 X 2,5

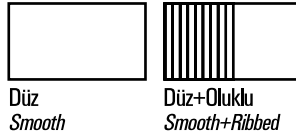

Kod Code	Ürün Adı Description	Ebatlar Dimension mm			Ağırlık Weight kg	Net Net m³	Güç Power kw	Fiyatı Price Euro
		a	b	c				
EMP.9IE020	Elektrikli Izgara-Düz Electric Grill-Smooth	800x900x285			106	0.21	12	1.100
EMP.9IE022	Elektrikli Izgara-Düz+Oluklu Electric Grill-Smooth+Ribbed	800x900x285			108	0.21	12	1.200
EMP.9IE020-K	EMP.9IE020 ve EMP.9IE022 için Krom Kaplama Farkı Chrome Coating Price Difference for EMP.9IE020 and EMP.9IE022							475

Setüstü / Countertop

Kod Code	Gaz Tüketim Değeri Gas Consumption Ng	Gaz Tüketim Değeri Gas Consumption Lpg
EMP.9IE020	400 V. AC 3N PE	5 X 4
EMP.9IE022	400 V. AC 3N PE	5 X 4

Türkçe
ELEKTRİKLİ IZGARALAR

- Termostatik kumanda.
- Tam modüllerde iki bölge ısıtma.
- Çıkarılabilir yağ toplama haznesi
- Kolay temizlenebilir ve hijyeniktir.
- Paslanmaz çelik gövde.

English
ELECTRIC GRILLS

- Thermostatic controller.
- Two separate heating zones.
- Removable oil collecting drawer.
- Easy to clean and hygienic.
- Stainless steel body.



EMP.9IE010+EMP.9TS010



EMP.9IE020+EMP.9TS020-K

Gazlı Lavataşlı Izgaralar Gas Lavastone Grills



Kod Code	Ürün Adı Description	Ebatlar Dimension mm			Ağırlık Weight kg	Net Net m³	Güç Power kw	Fiyatı Price Euro
		a	b	c				
EMP.9LG010	Lavataşlı Izgara - Gazlı Lavastone Grills - Gas	400x900x285			50	0.10	8.6	650

Setüstü / Countertop

Kod Code	Gaz Tüketim Değeri Gas Consumption Ng	Gaz Tüketim Değeri Gas Consumption Lpg
EMP.9LG010	0,9 m³/h	0,7 kg/h



Kod Code	Ürün Adı Description	Ebatlar Dimension mm			Ağırlık Weight kg	Net Net m³	Güç Power kw	Fiyatı Price Euro
		a	b	c				
EMP.9LG020	Lavataşlı Izgara - Gazlı Lavastone Grills - Gas	800x900x285			95	0.21	17.2	1.070

Setüstü / Countertop

Kod Code	Gaz Tüketim Değeri Gas Consumption Ng	Gaz Tüketim Değeri Gas Consumption Lpg
EMP.9LG020	1,8 m³/h	1,3 kg/h



Döküm üst ızgara Cast iron top

Türkçe

GAZLI LAVATAŞLI IZGARALAR

- Lpg ve Ng ile çalışabilme özelliği.
- Magnet emniyet ventilli ve pilotlu musluklar.
- Tam modüllerde iki bölgeyi ısıtma.
- Her brulör için piezzo çakmak ile kontrol.
- Çıkarılabilir yağ toplama haznesi.
- Kolay temizlenebilir ve hijyeniktir.
- Paslanmaz çelik gövde.

English

GAS LAVASTONE GRILLS

- Lpg or Ng.
- Magnet safety gas valve and pilot flame.
- Two separate heating zones.
- Piezoelectric ignition system for each burner.
- Removable oil collecting drawer.
- Easy to clean and hygienic.
- Stainless steel body.



EMP.9LG020+EMP.9TS020



EMP.9LG010+EMP.9TS010-K

Gazlı Sulu Izgara
 Gas Vapor Grill

Kod Code	Ürün Adı Description	Ebatlar Dimension mm			Ağırlık Weight kg	Net Net m³	Güç Power kw	Fiyatı Price Euro
		a	b	c				
EMP.9LG010-S	Gazlı Sulu Izgara Gas Vapor Grill	400	900	285	50	0.10	6.5	750

Setüstü / Countertop

Kod Code	Gaz Tüketim Değeri Gas Consumption Ng	Gaz Tüketim Değeri Gas Consumption Lpg
EMP.9LG010-S	0,7 m³/h	0,5 kg/h



Kod Code	Ürün Adı Description	Ebatlar Dimension mm			Ağırlık Weight kg	Net Net m³	Güç Power kw	Fiyatı Price Euro
		a	b	c				
EMP.9LG020-S	Gazlı Sulu Izgara Gas Vapor Grill	800	900	285	95	0.21	13	1.200

Setüstü / Countertop

Kod Code	Gaz Tüketim Değeri Gas Consumption Ng	Gaz Tüketim Değeri Gas Consumption Lpg
EMP.9LG020-S	1,4 m³/h	1,0 kg/h



Kod Code	Ürün Adı Description	Ebatlar Dimension mm			Ağırlık Weight kg	Net Net m³	Güç Power kw	Fiyatı Price Euro
		a	b	c				
EMP.9LG030-S	Gazlı Sulu Izgara Gas Vapor Grill	1200	900	285	120	0.31	19.5	1.725

Setüstü / Countertop

Kod Code	Gaz Tüketim Değeri Gas Consumption Ng	Gaz Tüketim Değeri Gas Consumption Lpg
EMP.9LG030-S	2,0 m³/h	1,5 kg/h

Türkçe
GAZLI SULU IZGARA

- Buharlaştırma kabini sayesinde daha verimli pişirme.
- Lpg ve Ng ile çalışabilme özelliği.
- Magnet emniyet ventilli ve pilotlu musluklar.
- Tam modüllerde iki bölgeyi ısıtma.
- Her brülör için piezo çakmak ile kontrol.
- Pisk döküm ızgara.
- Kolay temizlenebilir ve hijyeniktir.
- Paslanmaz çelik gövde.

English
GAS VAPOR GRILL

- Steamer cabinet provides fertile cooking.
- Lpg or Natural Gas.
- Magnet safety gas valve and pilot flame.
- Two separate heating zones.
- Piezoelectric ignition system for each burner.
- Cast iron plate.
- Easy to clean and hygienic.
- Stainless steel body.

Elektrikli Benmariler
Electric Bain maries



Kod Code	Ürün Adı Description	Ebatlar Dimension mm			Ağırlık Weight kg	Net Net m³	Güç Power kw	Fiyatı Price Euro
		a	b	c				
EMP.9SE010	Elektrikli Benmari Electric Bain marie	400	900	850	57	0.10	2	785

Dolaplı / With Cupboard

Kod Code	Gaz Tüketim Değeri Gas Consumption Ng	Gaz Tüketim Değeri Gas Consumption Lpg
EMP.9SE010	230 V. AC N PE	3 X 1,5

Kod Code	Ürün Adı Description	Ebatlar Dimension mm			Ağırlık Weight kg	Net Net m³	Güç Power kw	Fiyatı Price Euro
		a	b	c				
EMP.9SE020	Elektrikli Benmari Electric Bain marie	800	900	850	110	0.21	4	1.300

Dolaplı / With Cupboard

Kod Code	Gaz Tüketim Değeri Gas Consumption Ng	Gaz Tüketim Değeri Gas Consumption Lpg
EMP.9SE020	230 V. AC N PE	3 X 2,5

Kod Code	Ürün Adı Description	Ebatlar Dimension mm			Ağırlık Weight kg	Net Net m³	Güç Power kw	Fiyatı Price Euro
		a	b	c				
EMP.9SE010-K	Elektrikli Benmari Electric Bain marie	400	900	850	47	0.10	2	750

Dolaplı / With Cupboard

Kod Code	Gaz Tüketim Değeri Gas Consumption Ng	Gaz Tüketim Değeri Gas Consumption Lpg
EMP.9SE010-K	230 V. AC N PE	3 X 1,5

Kod Code	Ürün Adı Description	Ebatlar Dimension mm			Ağırlık Weight kg	Net Net m³	Güç Power kw	Fiyatı Price Euro
		a	b	c				
EMP.9SE020-K	Elektrikli Benmari Electric Bain marie	800	900	850	100	0.21	4	1.230

Dolaplı / With Cupboard

Kod Code	Gaz Tüketim Değeri Gas Consumption Ng	Gaz Tüketim Değeri Gas Consumption Lpg
EMP.9SE020	230 V. AC N PE	3 X 2,5



Türkçe

ELEKTRİKLİ BENMARİLER

- Termostatik kumanda.
- Yarım modülde 1 adet GN1/1.
- Tam modülde ise 2 adet GN1/1.
- Tahliye musluğu.
- Su alma musluğu.
- Kolay temizlenebilir ve hijyeniktir.
- Paslanmaz çelik gövde.

English

ELECTRIC BAIN MARIES

- Thermostatic controller.
- Capacity of half modul; 1 piece of GN1/1.
- Capacity of full modul; 2 pieces of GN1/1.
- Drainage valve.
- Water inlet valve.
- Easy to clean and hygienic.
- Stainless steel body.

*Standart üretimimizde
küvet bulunmamaktadır.

*Standart product does not
have containers.

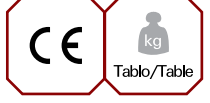
Ara Tezgahlar
Work Top

Kod Code	Ürün Adı Description	Ebatlar Dimension mm			Ağırlık Weight kg	Net Net m³	Güç Power kw	Fiyatı Price Euro
		a	b	c				
EMP.9TN010	Ara Tezgah Work Top	400	900	285	17	0.10	450	185

Setüstü / Countertop



Kod Code	Ürün Adı Description	Ebatlar Dimension mm			Ağırlık Weight kg	Net Net m³	Güç Power kw	Fiyatı Price Euro
		a	b	c				
EMP.9TN020	Ara Tezgah Work Top	800	900	285	34	0.21	670	260

Setüstü / Countertop

Türkçe

ARA TEZGAHLAR

- Tezgah üst yüzeyleri ara ya da ön hazırlıklar için idealdir.
- Kolay temizlenebilir ve hijyeniktir.
- Paslanmaz çelik gövde.

English

WORK TOP WITH CABINET

- Provides preliminary preparation by upper surfaces.
- Easy to clean and hygienic.
- Stainless steel body.



Set Altı Tezgah - Kapaklı

Undercounter Cabinet - With Door



Tablo/Table

Kod Code	Ürün Adı Description	Ebatlar Dimension mm			Ağırlık Weight kg	Net Net m³	Fiyatı Price Euro
		a	b	c			
EMP.9TS010	Set Altı Tezgah Undercounter Cabinet	400x847x565			21	0.10	230



Kod Code	Ürün Adı Description	Ebatlar Dimension mm			Ağırlık Weight kg	Net Net m³	Fiyatı Price Euro
		a	b	c			
EMP.9TS020	Set Altı Tezgah Undercounter Cabinet	800x847x565			30	0.21	325



Kod Code	Ürün Adı Description	Ebatlar Dimension mm			Ağırlık Weight kg	Net Net m³	Fiyatı Price Euro
		a	b	c			
EMP.9TS030	Set Altı Tezgah Undercounter Cabinet	1200x847x565			38	0.31	515



Set Altı Tezgah - Kapaksız
Undercounter Cabinet - Without Door



Kod Code	Ürün Adı Description	Ebatlar Dimension mm			Ağırlık Weight kg	Net Net m ³	Fiyatı Price Euro
		a	b	c			
EMP.9TS010-K	Set Altı Tezgah - Kapaksız Undercounter Cabinet - Without Door	400	847	565	21	0.14	195



Kod Code	Ürün Adı Description	Ebatlar Dimension mm			Ağırlık Weight kg	Net Net m ³	Fiyatı Price Euro
		a	b	c			
EMP.9TS020-K	Set Altı Tezgah - Kapaksız Undercounter Cabinet - Without Door	800	847	565	30	0.27	255



Kod Code	Ürün Adı Description	Ebatlar Dimension mm			Ağırlık Weight kg	Net Net m ³	Fiyatı Price Euro
		a	b	c			
EMP.9TS030-K	Set Altı Tezgah - Kapaksız Undercounter Cabinet - Without Door	1200	847	565	38	0.41	410

Set Altı Fırınlar - Gazlı
Ovens - Gas



Kod Code	Ürün Adı Description	Ebatlar Dimension mm			Ağırlık Weight kg	Net Net m³	Güç Power kw	Fiyatı Price Euro
		a	b	c				
EMP.9FRG01	Set Altı Fırınlar - Gazlı Ovens - Gas	800	847	565	60	0.27	12	870



Kod Code	Ürün Adı Description	Ebatlar Dimension mm			Ağırlık Weight kg	Net Net m³	Güç Power kw	Fiyatı Price Euro
		a	b	c				
EMP.9FRG02	Set Altı Fırınlar - Gazlı Ovens - Gas	1200	847	565	80	0.41	12	1.075



Kod Code	Ürün Adı Description	Ebatlar Dimension mm			Ağırlık Weight kg	Net Net m³	Güç Power kw	Fiyatı Price Euro
		a	b	c				
EMP.9FRG03	Set Altı Maxi Fırınlar - Gazlı Maxi Ovens - Gas	1200	847	565	90	0.41	24	1.375



Türkçe

SET ALTI FIRINLAR - GAZLI

- Lpg ve Ng ile çalışabilme özelliği.
- 2xGN 2/1 tepsi kapasiteli paslanmaz çelik fırın iç haznesi.
- Termostatik ayarlı fırın gaz ventili.

English

OVENS - GAS

- Lpg or Natural Gas
- 2xGN 2/1 capacity, stainless steel internal chamber.
- For oven: temperature control with thermostatic gas valve.

Set Altı Fırınlar - Elektrikli
Ovens - Electric



Kod Code	Ürün Adı Description	Ebatlar Dimension mm			Ağırlık Weight kg	Net Net m³	Güç Power kw	Fiyatı Price Euro
		a	b	c				
EMP.9FRE01	Set Altı Fırınlar - Elektrikli Ovens - Electric	800	847	565	60	0.27	9	870



Kod Code	Ürün Adı Description	Ebatlar Dimension mm			Ağırlık Weight kg	Net Net m³	Güç Power kw	Fiyatı Price Euro
		a	b	c				
EMP.9FRE02	Set Altı Fırınlar - Elektrikli Ovens - Electric	1200	847	565	80	0.41	9	1.075



Kod Code	Ürün Adı Description	Ebatlar Dimension mm			Ağırlık Weight kg	Net Net m³	Güç Power kw	Fiyatı Price Euro
		a	b	c				
EMP.9FRE03	Set Altı Maxi Fırınlar - Elektrikli Maxi Ovens - Electric	1200	847	565	90	0.41	15	1.375

Türkçe

SET ALTI FIRINLAR - ELEKTRİKLİ

- 2xGN 2/1 tepsi kapasiteli paslanmaz çelik fırın iç haznesi.

English

OVENS - ELECTRIC

- 2xGN 2/1 capacity, stainless steel internal chamber.

Kaynatma Tencereleri (İndirekt)

Boiling Pans (Indirect)



Kod Code	Ürün Adı Description	Ebatlar Dimension mm			Ağırlık Weight kg	Net Net m³	Güç Power kw	Kapasite Capacity lt	Fiyatı Price Euro
		a	b	c					
EMP.KTG.150	Kaynatma Tenceresi (Gazlı) Boiling Pan (Gas)	800x900x850			155	0.62	17.3	150	4.200
EMP.KTE.150	Kaynatma Tenceresi (Elektrikli) Boiling Pan (Electrical)	800x900x850			100	0.62	18	150	4.200
EMP.KTG.250	Kaynatma Tenceresi (Gazlı) Boiling Pan (Gas)	1000x900x850			250	0.92	25.3	250	6.000
EMP.KTE.250	Kaynatma Tenceresi (Elektrikli) Boiling Pan (Electrical)	1000x900x850			190	0.92	30	250	6.000

Kod Code	Elektrik Girişi Electric Input V	Kablo Kesiti Cable Cross Section mm²
EMP.KTE.150	380	5x6
EMP.KTE.250	380	5x10

Kod Code	Gaz Tüketim Değeri Gas Consumption Ng	Gaz Tüketim Değeri Gas Consumption Lpg
EMP.KTG.150	1,8 m³/h	1,3 kg/h
EMP.KTG.250	2,6 m³/h	1,9 kg/h



Türkçe

KAYNATMA TENCERELERİ (GAZLI)

- Lpg ve Ng ile çalışabilme özelliği.
- Magnet emniyet ventilli termokulp ve termostat.
- Aşırı basınç valfi ve manometre.
- Soğuk, sıcak su doldurma musluğu.
- Tahliye Musluğu.
- Karşı ağırlıklı kapak.
- Çift cidarlı ceket.
- Kolay temizlenebilir ve hijyeniktir.
- Paslanmaz çelik gövde.

KAYNATMA TENCERELERİ (ELEKTRİKLİ)

- Aşırı basınç valfi ve manometre.
- Soğuk, sıcak su doldurma musluğu.
- Tahliye Musluğu.
- Karşı ağırlıklı kapak.
- Çift cidarlı ceket.
- Kolay temizlenebilir ve hijyeniktir.
- Paslanmaz çelik gövde.

English

BOILING PANS (GAS)

- Lpg or Natural Gas.
- Safety gas valve thermocouple and thermostat.
- Over pressure safety valve and manometer.
- Cold, hot water inlet valve.
- Drainage valve.
- Counterweighted hinged lid.
- Double jacket pan.
- Easy to clean and hygienic.
- Stainless steel body.

BOILING PANS (ELECTRICAL)

- Over pressure safety valve and manometer.
- Cold, hot water inlet valve.
- Drainage valve.
- Counterweighted hinged lid.
- Double jacket pan.
- Easy to clean and hygienic.
- Stainless steel body.

Devrilir Tavalar
Tilting Pans



Kod Code	Ürün Adı Description	Ebatlar Dimension mm			Ağırlık Weight kg	Net Net m³	Güç Power kw	Kapasite Capacity lt	Fiyatı Price Euro
		a	b	c					
EMP.DTG.80	Devrilir Tava (Gazlı) Tilting Pan (Gas)	800x900x850			145	0.62	9.2	80	2.800
EMP.DTE.80	Devrilir Tava (Elektrikli) Tilting Pan (Electrical)	800x900x850			138	0.62	12	80	2.800
EMP.DTG.120	Devrilir Tava (Gazlı) Tilting Pan (Gas)	1200x900x850			215	0.92	10.4	120	3.750
EMP.DTE.120	Devrilir Tava (Elektrikli) Tilting Pan (Electrical)	1200x900x850			208	0.92	12	120	3.750

Kod Code	Elektrik Girişi Electric Input V	Kablo Kesiti Cable Cross Section mm²
EMP.DTE.80	380	5x4
EMP.DTE.120	380	5x6

Kod Code	Gaz Tüketim Değeri Gas Consumption Ng	Gaz Tüketim Değeri Gas Consumption Lpg
EMP.DTG.80	1,0 m³/h	0,7 kg/h
EMP.DTG.120	1,1 m³/h	0,8 kg/h

Türkçe

DEVİRİLİR TAVALAR (GAZLI)

- Lpg ve Ng ile çalışabilme özelliği.
- Magnet emniyet ventilli termokulp ve termostat.
- Manuel kaldırma mekanizması.
- Karşı ağırlıklı kapak.
- Güvenlik sensörü.
- Kolay temizlenebilir ve hijyeniktir.
- Paslanmaz çelik gövde.

DEVİRİLİR TAVALAR (ELEKTRİKLİ)

- Manuel kaldırma mekanizması.
- Karşı ağırlıklı kapak.
- Güvenlik sensörü.
- Kolay temizlenebilir ve hijyeniktir.
- Paslanmaz çelik gövde.

English

TILTING PANS (GAS)

- Lpg or Natural Gas.
- Safety gas valve thermocouple and thermostat.
- Manuel lift system.
- Counterweighted hinged lid.
- Safety switch.
- Easy to clean and hygienic.
- Stainless steel body.

TILTING PANS (ELECTRICAL)

- Manuel lift system.
- Counterweighted hinged lid.
- Safety switch.
- Easy to clean and hygienic.
- Stainless steel body.



900 Plus Serisi
900 Plus Serie



G|R|O|U|P

empero@empero.com.tr



Gazlı Ocaklar / Gas Cookers

Gazlı Ocaklar / Gas Cookers

Gazlı Wok Ocakları / Gas Wok Ranges

Elektrikli Ocaklar / Electric Cookers

Elektrikli Fritözler / Electric Fryers

Gazlı Fritözler / Gas Fryers

Elektrikli Makarna Haşlama - Patates Dinlendirme / Electric Pasta Cooker - Chips Cuttle

Gazlı Izgaralar / Gas Grills

Elektrikli Izgaralar / Electric Grills

Gazlı Lavataşlı Izgaralar / Gas Lavastone Grills

Gazlı Sulu Izgara / Gas Vapor Grill

Elektrikli Benmariler / Electric Bain maries

Ara Tezgahlar / Undercounter Worktop

Set Altı Dolaplar / Undercounter Cabinets

Set Altı Fırınlar - Gazlı / Ovens - Gas

Set Altı Fırınlar - Elektrikli / Ovens - Electric

Devrilir Tavalar / Tilting Pans

Kaynatma Tencereleri (İndirekt) / Boiling Pans (Indirect)

Cantilever Hat / Cantilever Line

Paslanmaz Alt Bazalar / Stainless Steel Box Spring

Gazlı Ocaklar
Gas Cookers



Kod Code	Ürün Adı Description	Ebatlar Dimension mm			Ağırlık Weight kg	Net Net m³	Güç Power kw	Fiyatı Price Euro
		a	b	c				
EMP.PLS.9KG010	2 Brülör'lü Gazlı Ocak 2 Burner Gas Cooker	400	900	300	40	0.11	21.5	865

Setüstü / C countertop

Kod Code	Gaz Tüketim Değeri Gas Consumption Ng	Gaz Tüketim Değeri Gas Consumption Lpg
EMP.PLS.9KG010	2,2 m³/h	1,6 kg/h



Kod Code	Ürün Adı Description	Ebatlar Dimension mm			Ağırlık Weight kg	Net Net m³	Güç Power kw	Fiyatı Price Euro
		a	b	c				
EMP.PLS.9KG020	4 Brülör'lü Gazlı Ocak 4 Burner Gas Cooker	800	900	300	82	0.22	43	1.585

Setüstü / C countertop

Kod Code	Gaz Tüketim Değeri Gas Consumption Ng	Gaz Tüketim Değeri Gas Consumption Lpg
EMP.PLS.9KG020	4,5 m³/h	3,3 kg/h



Türkçe

GAZLI OCAKLAR

- Lpg ve Ng ile çalışabilme özelliği.
- Magnet emniyet ventilli musluklar.
- Darbelere karşı dayanıklı üst döküm.
- Her brülör için piezzo çakmak ile kontrol.
- Kolay temizlenebilir ve hijyeniktir.
- Paslanmaz çelik gövde.

English

GAS COOKERS

- Lpg or Natural Gas
- Magnet safety valves.
- Heavy duty top cast iron.
- Piezoelectric ignition system for each burner.
- Easy to clean and hygienic.
- Stainless steel body.

2 mm üst tabla kalınlığı
2 mm top thickness



EMP.PLS.9KG020+EMP.PLS.9TS020

EMP.PLS.9KG020+EMP.PLS.9FRG01

EMP.PLS.9KG010+EMP.PLS.9TS010



Kod Code	Ürün Adı Description	Ebatlar Dimension mm			Ağırlık Weight kg	Net Net m³	Güç Power kw	Fiyatı Price Euro
		a	b	c				
EMP.PLS.9KG030	6 Brülör'lü Gazlı Ocak 6 Burner Gas Cooker	1200	900	300	120	0.32	64.5	2.275

Setüstü / C countertop

Kod Code	Gaz Tüketim Değeri Gas Consumption Ng	Gaz Tüketim Değeri Gas Consumption Lpg
EMP.PLS.9KG030	6,7 m³/h	4,9 kg/h



Kod Code	Ürün Adı Description	Ebatlar Dimension mm			Ağırlık Weight kg	Net Net m³	Güç Power kw	Fiyatı Price Euro
		a	b	c				
EMP.PLS.9YRG80	4 Yanışlı Ocak 4 Ring Cooker	800	900	300	90	0.21	32	1.265

Setüstü / C countertop

Kod Code	Gaz Tüketim Değeri Gas Consumption Ng	Gaz Tüketim Değeri Gas Consumption Lpg
EMP.PLS.9YRG80	3,3 m³/h	2,4 kg/h

Türkçe

GAZLI OCAKLAR

- Lpg ve Ng ile çalışabilme özelliği.
- Magnet emniyet ventilli musluklar.
- Darbelere karşı dayanıklı üst döküm.
- Her brülör için piezzo çakmak ile kontrol.
- Kolay temizlenebilir ve hijyeniktir.
- Paslanmaz çelik gövde.

2 mm üst tabla kalınlığı
2 mm top thickness

English

GAS COOKERS

- Lpg or Natural Gas.
- Magnet safety valves.
- Heavy duty top cast iron.
- Piezoelectric ignition system for each burner.
- Easy to clean and hygienic.
- Stainless steel body.



4 YANIŞLI BRULÖR
4 RING HIGH POWER BURNER



EMP.PLS.9KG030+EMP.PLS.9FRG03



EMP.PLS.9YRG80+EMP.PLS.9TS020

Gazlı Wok Ocakları
Gas Wok Cookers

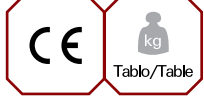

Kod Code	Ürün Adı Description	Ebatlar Dimension mm			Ağırlık Weight kg	Net Net m³	Güç Power kw	Fiyatı Price Euro
		a	b	c				
EMP.PLS.9WK010	1 Brülörlü Gazlı Wok Ocağı 1 Burner Gas Wok Cooker	400	900	300	40	0.11	18	765

Setüstü / Countertop

Kod Code	Gaz Tüketim Değeri Gas Consumption Ng	Gaz Tüketim Değeri Gas Consumption Lpg
EMP.PLS.9WK010	1,9 m³/h	1,4 kg/h



Kod Code	Ürün Adı Description	Ebatlar Dimension mm			Ağırlık Weight kg	Net Net m³	Güç Power kw	Fiyatı Price Euro
		a	b	c				
EMP.PLS.9WK020	2 Brülörlü Gazlı Wok Ocağı 2 Burner Gas Wok Cooker	800	900	300	79	0.22	2x18	1.300

Setüstü / Countertop

Kod Code	Gaz Tüketim Değeri Gas Consumption Ng	Gaz Tüketim Değeri Gas Consumption Lpg
EMP.PLS.9WK020	3,8 m³/h	2,8 kg/h



Kod Code	Ürün Adı Description	Ebatlar Dimension mm			Ağırlık Weight kg	Net Net m³	Güç Power kw	Fiyatı Price Euro
		a	b	c				
EMP.PLS.9WK030	3 Brülörlü Gazlı Wok Ocağı 3 Burner Gas Wok Cooker	1200	900	300	115	0.32	3x18	1.885

Setüstü / Countertop

Kod Code	Gaz Tüketim Değeri Gas Consumption Ng	Gaz Tüketim Değeri Gas Consumption Lpg
EMP.PLS.9WK030	5,6 m³/h	4,1 kg/h



2 mm üst tabla kalınlığı
2 mm top thickness

Elektrikli Ocaklar
Electric Cookers



Kod Code	Ürün Adı Description	Ebatlar Dimension mm			Ağırlık Weight kg	Net Net m ³	Güç Power kw	Fiyatı Price Euro
		a	b	c				
EMP.PLS.9KE010	2 Pleytli Elektrikli Ocak 2 Hot Plate Electric Cooker	400	900	300	45	0.11	8	985

Setüstü / C countertop

Kod Code	Elektrik Girişi Electric Input	Kablo Kesiti Cable Cross Section mm ²
EMP.PLS.9KE010	400 V. AC 3N PE	5 X 2,5



Kod Code	Ürün Adı Description	Ebatlar Dimension mm			Ağırlık Weight kg	Net Net m ³	Güç Power kw	Fiyatı Price Euro
		a	b	c				
EMP.PLS.9KE020	4 Pleytli Elektrikli Ocak 4 Hot Plate Electric Cooker	800	900	300	90	0.22	16	1.650

Setüstü / C countertop

Kod Code	Elektrik Girişi Electric Input	Kablo Kesiti Cable Cross Section mm ²
EMP.PLS.9KE020	400 V. AC 3N PE	5 X 4



Kod Code	Ürün Adı Description	Ebatlar Dimension mm			Ağırlık Weight kg	Net Net m ³	Güç Power kw	Fiyatı Price Euro
		a	b	c				
EMP.PLS.9KE030	6 Pleytli Elektrikli Ocak 6 Hot Plate Electric Cooker	1200	900	300	125	0.32	24	2.600

Setüstü / C countertop

Kod Code	Elektrik Girişi Electric Input	Kablo Kesiti Cable Cross Section mm ²
EMP.PLS.9KE030	400 V. AC 3N PE	5 X 6

Türkçe

ELEKTRİKLİ OCAKLAR

- 6 kademeli şalter.
- Kolay temizlenebilir ve hijyeniktir.
- Paslanmaz çelik gövde.

English

ELECTRIC COOKERS

- 6 position switch.
- Easy to clean and hygienic.
- Stainless steel body.

2 mm üst tabla kalınlığı
2 mm top thickness



EMP.PLS.9KE030+EMP.PLS.9FRE020



EMP.PLS.9KE020+EMP.PLS.9TS020



EMP.PLS.9KE010+EMP.PLS.9TS010

Elektrikli Fritözler
Electric Fryers



Kod Code	Ürün Adı Description	Ebatlar Dimension mm			Ağırlık Weight kg	Net Net m ³	Güç Power kw	Kapasite Capacity lt	Fiyatı Price Euro
		a	b	c					
EMP.PLS.9FE010	Elektrikli Fritöz Electric Fryer	400	900	850	70	0.11	18	24	1.380

Dolaplı / With Cupboard

Kod Code	Elektrik Girişi Electric Input	Kablo Kesiti Cable Cross Section mm ²
EMP.PLS.9FE010	400 V. AC 3N PE	5 X 4



Kod Code	Ürün Adı Description	Ebatlar Dimension mm			Ağırlık Weight kg	Net Net m ³	Güç Power kw	Kapasite Capacity lt	Fiyatı Price Euro
		a	b	c					
EMP.PLS.9FE020	Elektrikli Fritöz Electric Fryer	800	900	850	140	0.22	36	2X24	2.345

Dolaplı / With Cupboard

Kod Code	Elektrik Girişi Electric Input	Kablo Kesiti Cable Cross Section mm ²
EMP.PLS.9FE020	400 V. AC 3N PE	5 X 6



2 mm üst tabla kalınlığı
2 mm top thickness

Türkçe

ELEKTRİKLİ FRITÖZLER

- Termostatik kumanda.
- Paslanmaz çelik sepetler.
- Hareketli ısıtıcılar kolay temizlik imkanı sağlar.
- Boşaltma borusu ile emniyetli yağ boşaltma.
- Limit termostat.
- Kolay temizlenebilir ve hijyeniktir.
- Paslanmaz çelik gövde.

English

ELECTRIC FRYERS

- Thermostatic control.
- Stainless steel baskets.
- Moving heaters provide easy cleaning.
- Safe oil drainage from the bottom via valve.
- Safety thermostat for overheating protection.
- Easy to clean and hygienic.
- Stainless steel body.



Gazlı Fritözler
Gas Fryers

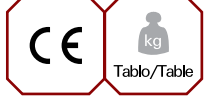

Kod Code	Ürün Adı Description	Ebatlar Dimension mm			Ağırlık Weight kg	Net Net m³	Güç Power kw	Kapasite Capacity lt	Fiyatı Price Euro
		a	b	c					
EMP.PLS.9FG010	Gazlı Fritöz Gas Fryer	400	900	850	80	0.31	12	24	1.530

Dolaplı / With Cupboard

Kod Code	Gaz Tüketim Değeri Gas Consumption Ng	Gaz Tüketim Değeri Gas Consumption Lpg
EMP.PLS.9FG010	2,5 m³/h	1,8 kg/h



Kod Code	Ürün Adı Description	Ebatlar Dimension mm			Ağırlık Weight kg	Net Net m³	Güç Power kw	Kapasite Capacity lt	Fiyatı Price Euro
		a	b	c					
EMP.PLS.9FG020	Gazlı Fritöz Gas Fryer	800	900	850	155	0.62	24	2X24	2.600

Dolaplı / With Cupboard

Kod Code	Gaz Tüketim Değeri Gas Consumption Ng	Gaz Tüketim Değeri Gas Consumption Lpg
EMP.PLS.9FG020	5 m³/h	3,7 kg/h

Türkçe

GAZLI FRİTÖZLER

- Lpg ve Ng ile çalışabilme özelliği.
- 220 V 50 Hz. çalışma voltajı.
- Termostatik kumanda.
- Paslanmaz çelik sepetler.
- Magnet emniyet ventilli musluklar.
- Boşaltma borusu ile emniyetli yağ boşaltma.
- Limit termostat.
- Kolay temizlenebilir ve hijyeniktir.
- Paslanmaz çelik gövde.

English

GAS FRYERS

- Lpg or Ng.
- Operating voltage: 220V 50 Hz.
- Thermostatic control.
- Stainless steel baskets.
- Magnet safety gas valve and thermocouple.
- Safe oil drainage from the bottom via valve.
- Safety thermostat for overheating protection.
- Easy to clean and hygienic.
- Stainless steel body.

2 mm üst tabla kalınlığı
2 mm top thickness



Elektrikli Makarna Haşlama - Patates Dinlendirme Electric Pasta Cooker - Chips Cuttle



Kod Code	Ürün Adı Description	Ebatlar Dimension mm			Ağırlık Weight kg	Net Net m ³	Güç Power kw	Fiyatı Price Euro
		a	b	c				
EMP.PLS.9ME010	Elektrikli Makarna Haşlama Electric Pasta Cooker	400	900	850	80	0.11	12	1.600

Dolaplı / With Cupboard

Kod Code	Elektrik Girişi Electric Input	Kablo Kesiti Cable Cross Section mm ²
EMP.PLS.9ME010	400 V. AC 3N PE	5 X 4

Kod Code	Ürün Adı Description	Ebatlar Dimension mm			Ağırlık Weight kg	Net Net m ³	Güç Power kw	Fiyatı Price Euro
		a	b	c				
EMP.PLS.9DE010	Patates Dinlendirme Chips Scuttle	400	900	300	25	0.11	0.65	550

Setüstü / Countertop

Kod Code	Elektrik Girişi Electric Input	Kablo Kesiti Cable Cross Section mm ²
EMP.PLS.9DE010	230 V. AC N PE	3 X 1,5



2 mm üst tabla kalınlığı
2 mm top thickness



Türkçe

ELEKTRİKLİ MAKARNA HAŞLAMA

- Termostatik kontrol.
- Paslanmaz çelik sepetler.
- Su doldurma musluğu.
- Tahliye musluğu ile su boşaltma.
- Taşan su tahliye sistemi.
- Kolay temizlenebilir ve hijyeniktir.
- Paslanmaz çelik gövde.

PATATES DİNLENDİRME

- Kızartılmış patateslerin sıcak bekletilmesinde ve yağların süzülmesinde kullanılır.
- GN 1/1X150 mm kuvvet kapasitesi.
- Infrared seramik ısıtıcı.
- Havuzda kızartma yağının süzülmesi için maksimum verim sağlayan özel form.
- Kolay temizlenebilir ve hijyeniktir.
- Paslanmaz çelik gövde.

English

ELECTRIC PASTA COOKER

- Thermostatic control.
- Stainless steel baskets.
- Water filling tap.
- Discharge valve.
- Overflow drainage system.
- Easy to clean and hygienic.
- Stainless steel body.

CHIPS SCUTTLE

- Operates in order to keep fried food warm and drain oil.
- Capacity: GN 1/1X150 mm
- Ceramic infrared heater.
- Special form on the container, provides maximum efficiency in order to drain oil.
- Easy to clean and hygienic.
- Stainless steel body.

Gazlı Izgaralar
 Gas Grills



Kod Code	Ürün Adı Description	Ebatlar Dimension mm			Ağırlık Weight kg	Net Net m³	Güç Power kw	Fiyatı Price Euro
		a	b	c				
EMP.PLS.9IG010	Gazlı Izgara-Düz Gas Grill-Smooth	400	900	300	60	0.11	12	1.200

Setüstü / Countertop

Kod Code	Gaz Tüketim Değeri Gas Consumption Ng	Gaz Tüketim Değeri Gas Consumption Lpg
EMP.PLS.9IG010	1,3 m³/h	0,9 kg/h

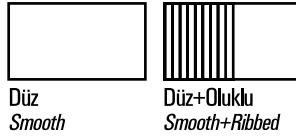

Kod Code	Ürün Adı Description	Ebatlar Dimension mm			Ağırlık Weight kg	Net Net m³	Güç Power kw	Fiyatı Price Euro
		a	b	c				
EMP.PLS.9IG020	Gazlı Izgara-Düz Gas Grill-Smooth	800	900	300	100	0.22	24	1.775
EMP.PLS.9IG022	Gazlı Izgara-Düz+Oluklu Gas Grill-Smooth+Ribbed	800	900	300	105	0.22	24	1.875

Setüstü / Countertop

Kod Code	Gaz Tüketim Değeri Gas Consumption Ng	Gaz Tüketim Değeri Gas Consumption Lpg
EMP.PLS.9IG020	2,5 m³/h	1,8 kg/h
EMP.PLS.9IG022	2,5 m³/h	1,8 kg/h

Türkçe
GAZLI IZGARALAR

- Lpg ve Ng ile çalışabilme özelliği.
- Magnet emniyet ventilli ve pilotlu musluklar.
- Tam modüllerde iki bölgeyi ısıtma.
- Her brülör için piezzo çakmak ile kontrol.
- Çıkarılabilir yağ toplama haznesi
- Kolay temizlenebilir ve hijyeniktir.
- Paslanmaz çelik gövde.

English
GAS GRILLS

- Lpg or Natural Gas.
- Magnet safety gas valve and pilot flame.
- Two separate heating zones.
- Piezoelectric ignition system for each burner.
- Removable oil collecting drawer.
- Easy to clean and hygienic.
- Stainless steel body.

2 mm üst tabla kalınlığı
2 mm top thickness
Krom Tablalı
Chrome Plate

EMP.PLS.9IG020+EMP.PLS.9TS020

EMP.PLS.9IG010+EMP.PLS.9TS010

Elektrikli Izgaralar
Electric Grills



Kod Code	Ürün Adı Description	Ebatlar Dimension mm			Ağırlık Weight kg	Net Net m³	Güç Power kw	Fiyatı Price Euro
		a	b	c				
EMP.PLS.9IE010	Elektrikli Izgara-Düz Electric Grill-Smooth	400	900	300	60	0.11	6	1.225

Setüstü / Countertop

Kod Code	Elektrik Girişi Electric Input	Kablo Kesiti Cable Cross Section mm²
EMP.PLS.9IE010	400 V. AC 3N PE	5 X 2,5



Kod Code	Ürün Adı Description	Ebatlar Dimension mm			Ağırlık Weight kg	Net Net m³	Güç Power kw	Fiyatı Price Euro
		a	b	c				
EMP.PLS.9IE020	Elektrikli Izgara-Düz Electric Grill-Smooth	800	900	300	100	0.22	12	1.900
EMP.PLS.9IE022	Elektrikli Izgara- Düz+Oluklu Electric Grill- Smooth+Ribbed	800	900	300	105	0.22	12	2.000

Setüstü / Countertop

Kod Code	Elektrik Girişi Electric Input	Kablo Kesiti Cable Cross Section mm²
EMP.PLS.9IE020	400 V. AC 3N PE	5 X 4
EMP.PLS.9IE022	400 V. AC 3N PE	5 X 4

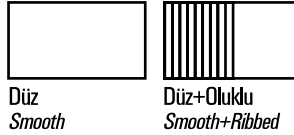

2 mm üst tabla kalınlığı
2 mm top thickness

Krom Tablalı
Chrome Plate



EMP.PLS.9IE020+EMP.PLS.9TS020

EMP.PLS.9IE010+EMP.PLS.9TS010

Türkçe

ELEKTRİKLİ IZGARALAR

- Termostatik kumanda.
- Tam modüllerde iki bölgeyi ısıtma.
- Çıkarılabilir yağ toplama haznesi.
- Kolay temizlenebilir ve hijyeniktir.
- Paslanmaz çelik gövde.

English

ELECTRIC GRILLS

- Thermostatic controller.
- Two separate heating zones.
- Removable oil collecting drawer.
- Easy to clean and hygienic.
- Stainless steel body.

Gazlı Lavataşlı Izgaralar
Gas Lavastone Grills



Kod Code	Ürün Adı Description	Ebatlar Dimension mm			Ağırlık Weight kg	Net Net m³	Güç Power kw	Fiyatı Price Euro
		a	b	c				
EMP.PLS.9LG010	Lavataşlı Izgara - Gazlı Lavastone Grills - Gas	400	900	300	57	0.11	7.6	780

Setüstü / Countertop

Kod Code	Gaz Tüketim Değeri Gas Consumption Ng	Gaz Tüketim Değeri Gas Consumption Lpg
EMP.PLS.9LG010	0,80 m³/h	0,6 kg/h



Kod Code	Ürün Adı Description	Ebatlar Dimension mm			Ağırlık Weight kg	Net Net m³	Güç Power kw	Fiyatı Price Euro
		a	b	c				
EMP.PLS.9LG020	Lavataşlı Izgara - Gazlı Lavastone Grills - Gas	800	900	300	110	0.22	15.2	1.285

Setüstü / Countertop

Kod Code	Gaz Tüketim Değeri Gas Consumption Ng	Gaz Tüketim Değeri Gas Consumption Lpg
EMP.PLS.9LG020	1,61 m³/h	1,20 kg/h

Türkçe

GAZLI LAVATAŞLI IZGARALAR

- Lpg ve Ng ile çalışabilme özelliği.
- Magnet emniyet ventilli ve pilotlu musluklar.
- Tam modüllerde iki bölgeyi ısıtma.
- Her brülör için piezzo çakmak ile kontrol.
- Çıkarılabilir yağ toplama haznesi
- Kolay temizlenebilir ve hijyeniktir.
- Paslanmaz çelik gövde.

English

GAS LAVASTONE GRILLS

- Lpg or Ng.
- Magnet safety gas valve and pilot flame.
- Two separate heating zones.
- Piezoelectric ignition system for each burner.
- Removable oil collecting drawer.
- Easy to clean and hygienic.
- Stainless steel body.

2 mm üst tabla kalınlığı
2 mm top thickness

Döküm üst izgara
Cast iron top



EMP.PLS.9LG020+EMP.PLS.9TS020



EMP.PLS.9LG010+EMP.PLS.9TS010

Gazlı Sulu Izgara
Gas Vapor Grill



Kod Code	Ürün Adı Description	Ebatlar Dimension mm			Ağırlık Weight kg	Net Net m³	Güç Power kw	Fiyatı Price Euro
		a	b	c				
EMP.PLS.9LG010-S	Gazlı Sulu Izgara Gas Vapor Grill	400	900	300	57	0.11	10.3	900

Setüstü / Countertop

Kod Code	Gaz Tüketim Değeri Gas Consumption Ng	Gaz Tüketim Değeri Gas Consumption Lpg
EMP.PLS.9LG010-S	1,07 m³/h	0,80 kg/h



Kod Code	Ürün Adı Description	Ebatlar Dimension mm			Ağırlık Weight kg	Net Net m³	Güç Power kw	Fiyatı Price Euro
		a	b	c				
EMP.PLS.9LG020-S	Gazlı Sulu Izgara Gas Vapor Grill	800	900	300	110	0.22	20.6	1.450

Setüstü / Countertop

Kod Code	Gaz Tüketim Değeri Gas Consumption Ng	Gaz Tüketim Değeri Gas Consumption Lpg
EMP.PLS.9LG020-S	2,14 m³/h	1,60 kg/h



Kod Code	Ürün Adı Description	Ebatlar Dimension mm			Ağırlık Weight kg	Net Net m³	Güç Power kw	Fiyatı Price Euro
		a	b	c				
EMP.PLS.9LG030-S	Gazlı Sulu Izgara Gas Vapor Grill	1200	900	300	135	0.32	30.9	2.075

Setüstü / Countertop

Kod Code	Gaz Tüketim Değeri Gas Consumption Ng	Gaz Tüketim Değeri Gas Consumption Lpg
EMP.PLS.9LG030-S	3,22 m³/h	2,40 kg/h



2 mm üst tabla kalınlığı
2 mm top thickness



EMP.PLS.9LG030-S+EMP.PLS.9TS030

Türkçe

GAZLI SULU IZGARA

- Buharlaştırma kabini sayesinde daha verimli pişirme.
- Lpg ve Ng ile çalışabilme özelliği.
- Magnet emniyet ventilli ve pilotlu musluklar.
- Tam modüllerde iki bölgeyi ısıtma.
- Her brülör için piezo çakmak ile kontrol.
- Pik döküm ızgara.
- Kolay temizlenebilir ve hijyeniktir.
- Paslanmaz çelik gövde.

English

GAS VAPOR GRILL

- Steamer cabinet provides fertile cooking.
- Lpg or Natural Gas.
- Magnet safety gas valve and pilot flame.
- Two separate heating zones.
- Piezoelectric ignition system for each burner.
- Cast iron plate.
- Easy to clean and hygienic.
- Stainless steel body.

Elektrikli Benmariler
Electric Bain maries

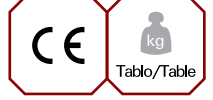

Kod Code	Ürün Adı Description	Ebatlar Dimension mm			Ağırlık Weight kg	Net Net m³	Güç Power kw	Fiyatı Price Euro
		a	b	c				
EMP.PLS.9SE010	Elektrikli Benmari Electric Bain marie	400x900x800			67	0.11	2.5	945

Dolaplı / With Cupboard

Kod Code	Gaz Tüketim Değeri Gas Consumption Ng	Gaz Tüketim Değeri Gas Consumption Lpg
EMP.PLS.9SE010	230 V. AC N PE	3 X 1,5



Kod Code	Ürün Adı Description	Ebatlar Dimension mm			Ağırlık Weight kg	Net Net m³	Güç Power kw	Fiyatı Price Euro
		a	b	c				
EMP.PLS.9SE020	Elektrikli Benmari Electric Bain marie	800x900x800			120	0.22	4.4	1.565

Dolaplı / With Cupboard

Kod Code	Gaz Tüketim Değeri Gas Consumption Ng	Gaz Tüketim Değeri Gas Consumption Lpg
EMP.PLS.9SE020	230 V. AC N PE	3 X 2,5

Türkçe

ELEKTRİKLİ BENMARİLER

- Termostatik kumanda.
- Yarım modülde 1 adet GN1/1.
- Tam modülde ise 2 adet GN1/1.
- Tahliye musluğu.
- Su alma musluğu.
- Kolay temizlenebilir ve hijyeniktir.
- Paslanmaz çelik gövde.

*Standart üretimimizde küvet bulunmamaktadır.

English

ELECTRIC BAIN MARIES

- Thermostatic controller.
- Capacity of half modul; 1 piece of GN1/1.
- Capacity of full modul; 2 pieces of GN1/1.
- Drainage valve.
- Water inlet valve.
- Easy to clean and hygienic.
- Stainless steel body.

*Standart product does not have containers.

2 mm üst tabla kalınlığı
2 mm top thickness

Ara Tezgahlar
Undercounter Worktop



Kod Code	Ürün Adı Description	Ebatlar Dimension mm			Ağırlık Weight kg	Net Net m³	Fiyatı Price Euro
		a	b	c			
EMP.PLS.9TN010	Ara Tezgah 1/2 Mod Worktop 1/2 Module	400	900	300	20	0.11	270

Setüstü / Countertop



Kod Code	Ürün Adı Description	Ebatlar Dimension mm			Ağırlık Weight kg	Net Net m³	Fiyatı Price Euro
		a	b	c			
EMP.PLS.9TN020	Ara Tezgah / 1 Mod Worktop 1 Module	800	900	300	37	0.22	425

Setüstü / Countertop



2 mm üst tabla kalınlığı
2 mm top thickness

Türkçe

ARA TEZGAHLAR

- Tezgahlar 60 seri cihazların altına kullanılabilecek uygun modüler ölçülerdedir.
- Kolay temizlenebilir ve hijyeniktir.
- Paslanmaz çelik gövde.

English

UNDERCOUNTER CABINET

- Under-Set Counters are suitable to use under each kind of 60's serie equipments.
- Easy to clean and hygienic.
- Stainless steel body.



EMP.PLS.9TN020+EMP.PLS.9TS020



EMP.PLS.9TN010+EMP.PLS.9TS010

Set Altı Dolaplar
Undercounter Cabinets



Kod Code	Ürün Adı Description	Ebatlar Dimension mm			Ağırlık Weight kg	Net Net m³	Fiyatı Price Euro
		a	b	c			
EMP.PLS.9TS010	Set Altı Tezgah Undercounter Cabinet	400x790x550			21	0.15	335



Kod Code	Ürün Adı Description	Ebatlar Dimension mm			Ağırlık Weight kg	Net Net m³	Fiyatı Price Euro
		a	b	c			
EMP.PLS.9TS020	Set Altı Tezgah Undercounter Cabinet	800x790x550			30	0.22	480



Kod Code	Ürün Adı Description	Ebatlar Dimension mm			Ağırlık Weight kg	Net Net m³	Fiyatı Price Euro
		a	b	c			
EMP.PLS.9TS030	Set Altı Tezgah Undercounter Cabinet	1200x790x550			38	0.33	795

Set Altı Fırınlar - Gazlı
Ovens - Gas



Kod Code	Ürün Adı Description	Ebatlar Dimension mm			Ağırlık Weight kg	Net Net m ³	Güç Power kw	Fiyatı Price Euro
		a	b	c				
EMP.PLS.9FRG01	Set Altı Fırınlar - Gazlı Ovens - Gas	800	790	550	70	0.32	12	950



Kod Code	Ürün Adı Description	Ebatlar Dimension mm			Ağırlık Weight kg	Net Net m ³	Güç Power kw	Fiyatı Price Euro
		a	b	c				
EMP.PLS.9FRG02	Set Altı Fırınlar - Gazlı Ovens - Gas	1200	790	550	90	0.52	12	1.185



Kod Code	Ürün Adı Description	Ebatlar Dimension mm			Ağırlık Weight kg	Net Net m ³	Güç Power kw	Fiyatı Price Euro
		a	b	c				
EMP.PLS.9FRG03	Set Altı Maxi Fırınlar - Gazlı Maxi Ovens - Gas	1200	790	550	100	0.52	24	1.500



Türkçe

SET ALTI FIRINLAR - GAZLI

- Lpg ve Ng ile çalışabilme özelliği.
- 2xGN 2/1 tepsi kapasiteli paslanmaz çelik fırın iç haznesi.
- Termostatik ayarlı fırın gaz ventili.

English

OVENS - GAS

- Lpg or Natural Gas.
- 2xGN 2/1 capacity, stainless steel internal chamber.
- For oven: temperature control with thermostatic gas valve.

Set Altı Fırınlar - Elektrikli
Ovens - Electric

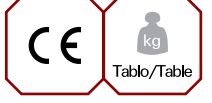

Kod Code	Ürün Adı Description	Ebatlar Dimension mm			Ağırlık Weight kg	Net Net m³	Güç Power kw	Fiyatı Price Euro
		a	b	c				
EMP.PLS.9FRE01	Set Altı Fırınlar - Elektrikli Ovens - Electric	800	790	550	70	0.32	9	950



Kod Code	Ürün Adı Description	Ebatlar Dimension mm			Ağırlık Weight kg	Net Net m³	Güç Power kw	Fiyatı Price Euro
		a	b	c				
EMP.PLS.9FRE02	Set Altı Fırınlar - Elektrikli Ovens - Electric	1200	790	550	90	0.52	9	1.185



Kod Code	Ürün Adı Description	Ebatlar Dimension mm			Ağırlık Weight kg	Net Net m³	Güç Power kw	Fiyatı Price Euro
		a	b	c				
EMP.PLS.9FRE03	Set Altı Maxi Fırınlar - Elektrikli Maxi Ovens - Electric	1200	790	550	100	0.52	15	1.500

Türkçe

English

SET ALTI FIRINLAR - ELEKTRİKLİ

OVENS - ELECTRIC

- 2xGN 2/1 tepsi kapasiteli paslanmaz çelik fırın iç haznesi. - 2xGN 2/1 capacity, stainless steel internal chamber.

Devrilir Tavalar
Tilting Pans



Kod Code	Ürün Adı Description	Ebatlar Dimension mm			Ağırlık Weight kg	Net Net m³	Güç Power kw	Kapasite Capacity lt	Fiyatı Price Euro
		a	b	c					
EMP.PLS.DTG.80	Devrilir Tava (Gazlı) Tilting Pan (Gas)	800x900x850			145	0.62	21	80	3.080
EMP.PLS.DTE.80	Devrilir Tava (Elektrikli) Tilting Pan (Electrical)	800x900x850			138	0.62	12	80	3.080
EMP.PLS.DTG.120	Devrilir Tava (Gazlı) Tilting Pan (Gas)	1200x900x850			215	0.92	30	120	4.125
EMP.PLS.DTE.120	Devrilir Tava (Elektrikli) Tilting Pan (Electrical)	1200x900x850			208	0.92	12	120	4.125

Kod Code	Elektrik Girişi Electric Input V	Kablo Kesiti Cable Cross Section mm²
EMP. PLS. DTE.80	380	5x4
EMP. PLS. DTE.120	380	5x6

Kod Code	Gaz Tüketim Değeri Gas Consumption Ng	Gaz Tüketim Değeri Gas Consumption Lpg
EMP. PLS. DTG.80	0,72 m³/h	0,54 kg/h
EMP. PLS. DTG.120	0,96 m³/h	0,72 kg/h

Türkçe

DEVİRİLİR TAVALAR (GAZLI)

- Lpg ve Ng ile çalışabilme özelliği.
- Magnet emniyet ventilli termokulp ve termostat.
- Manuel kaldırma mekanizması.
- Karşı ağırlıklı kapak.
- Güvenlik sensörü.
- Kolay temizlenebilir ve hijyeniktir.
- Paslanmaz çelik gövde.

DEVİRİLİR TAVALAR (ELEKTRİKLİ)

- Manuel kaldırma mekanizması.
- Karşı ağırlıklı kapak.
- Güvenlik sensörü.
- Kolay temizlenebilir ve hijyeniktir.
- Paslanmaz çelik gövde.

English

TILTING PANS (GAS)

- Lpg or Natural Gas.
- Safety gas valve thermocouple and thermostat.
- Manuel lift system.
- Counterweighted hinged lid.
- Safety switch.
- Easy to clean and hygienic.
- Stainless steel body.

TILTING PANS (ELECTRICAL)

- Manuel lift system.
- Counterweighted hinged lid.
- Safety switch.
- Easy to clean and hygienic.
- Stainless steel body.

Kaynatma Tencereleri (İndirekt)
Boiling Pans (Indirect)



Kod Code	Ürün Adı Description	Ebatlar Dimension mm			Ağırlık Weight kg	Net Net m³	Güç Power kw	Kapasite Capacity lt	Fiyatı Price Euro
		a	b	c					
EMP.PLS.KTG.150	Kaynatma Tenceresi (Gazlı) Boiling Pan (Gas)	800x900x850			155	0.62	17.3	150	4.600
EMP. PLS.KTE.150	Kaynatma Tenceresi (Elektrikli) Boiling Pan (Electrical)	800x900x850			100	0.62	18	150	4.600
EMP. PLS.KTG.250	Kaynatma Tenceresi (Gazlı) Boiling Pan (Gas)	1000x900x850			250	0.92	25.3	250	7.200
EMP. PLS.KTE.250	Kaynatma Tenceresi (Elektrikli) Boiling Pan (Electrical)	1000x900x850			190	0.92	30	250	7.200

Kod Code	Elektrik Girişi Electric Input V	Kablo Kesiti Cable Cross Section mm²
EMP. PLS.KTE.150	380	5x6
EMP. PLS.KTE.250	380	5x10

Kod Code	Gaz Tüketim Değeri Gas Consumption Ng	Gaz Tüketim Değeri Gas Consumption Lpg
EMP. PLS.KTG.150	1,8 m³/h	1,3 kg/h
EMP. PLS.KTG.250	2,6 m³/h	1,9 kg/h

Türkçe

KAYNATMA TENCERELERİ (GAZLI)

- Lpg ve Ng ile çalışabilme özelliği.
- Magnet emniyet ventilli termokulp ve termostat.
- Aşırı basınç valfi ve manometre.
- Soğuk, sıcak su doldurma musluğu.
- Tahliye Musluğu.
- Karşı ağırlıklı kapak.
- Çift cidarlı ceket.
- Kolay temizlenebilir ve hijyeniktir.
- Paslanmaz çelik gövde.

KAYNATMA TENCERELERİ (ELEKTRİKLİ)

- Aşırı basınç valfi ve manometre.
- Soğuk, sıcak su doldurma musluğu.
- Tahliye Musluğu.
- Karşı ağırlıklı kapak.
- Çift cidarlı ceket.
- Kolay temizlenebilir ve hijyeniktir.
- Paslanmaz çelik gövde.

English

BOILING PANS (GAS)

- Lpg or Natural Gas.
- Safety gas valve thermocouple and thermostat.
- Over pressure safety valve and manometer.
- Cold, hot water inlet valve.
- Drainage valve.
- Counterweighted hinged lid.
- Double jacket pan.
- Easy to clean and hygienic.
- Stainless steel body.

BOILING PANS (ELECTRICAL)

- Over pressure safety valve and manometer.
- Cold, hot water inlet valve.
- Drainage valve.
- Counterweighted hinged lid.
- Double jacket pan.
- Easy to clean and hygienic.
- Stainless steel body.



Cantilever Hat
Cantilever Line



Tablo/Table



Kod Code	Ürün Adı Description	Ebatlar Dimension mm			Fiyatı Price Euro
		a	b	c	
EMP.PLS.9CTV240	Cantilever Hat Cantilever Line	2400x1710x550			3.450

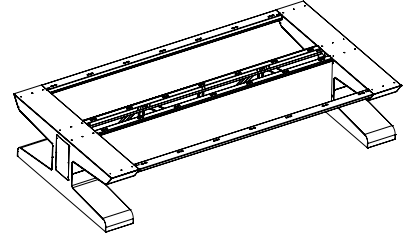

Kod Code	Ürün Adı Description	Ebatlar Dimension mm			Fiyatı Price Euro
		a	b	c	
EMP.PLS.9CTV280	Cantilever Hat Cantilever Line	2800x1710x550			4.250

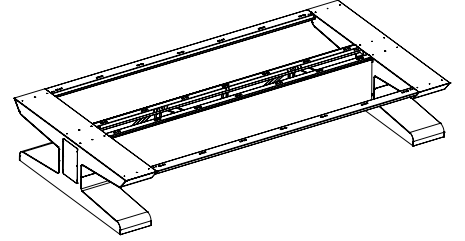

Kod Code	Ürün Adı Description	Ebatlar Dimension mm			Fiyatı Price Euro
		a	b	c	
EMP.PLS.9CTV320	Cantilever Hat Cantilever Line	3200x1710x550			4.600

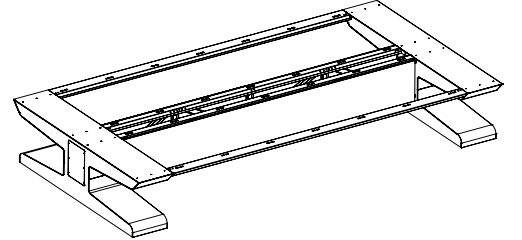

Kod Code	Ürün Adı Description	Ebatlar Dimension mm			Fiyatı Price Euro
		a	b	c	
EMP.PLS.9CTV360	Cantilever Hat Cantilever Line	3600x1710x550			5.400

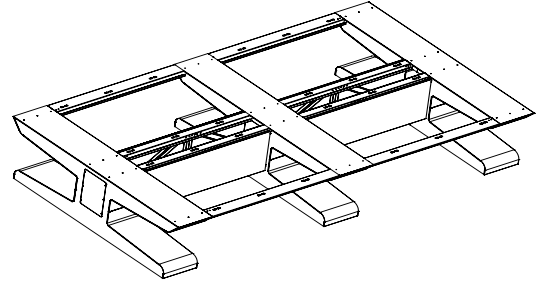

Kod Code	Ürün Adı Description	Ebatlar Dimension mm			Fiyatı Price Euro
		a	b	c	
EMP.PLS.9CTV400	Cantilever Hat Cantilever Line	4000x1710x550			5.750

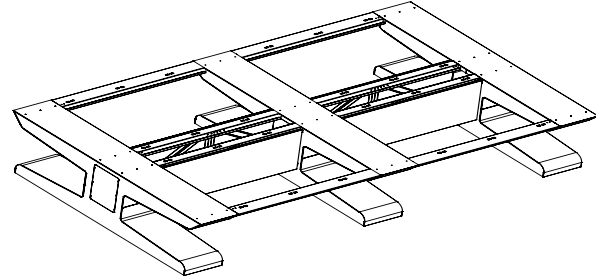

Gazlı fritözler, Elektrikli fritözler, Elektrikli Benmariler, Elektrikli Makarna
Haşlamalar ürünlerinde ALT KISIM dolaplı olarak gelmektedir.

For Gas Fryers , Electrical Fryers , Electrical Bainmaries and Electrical Pasta
Cookers BOTTOM SIDE includes Cabinet.

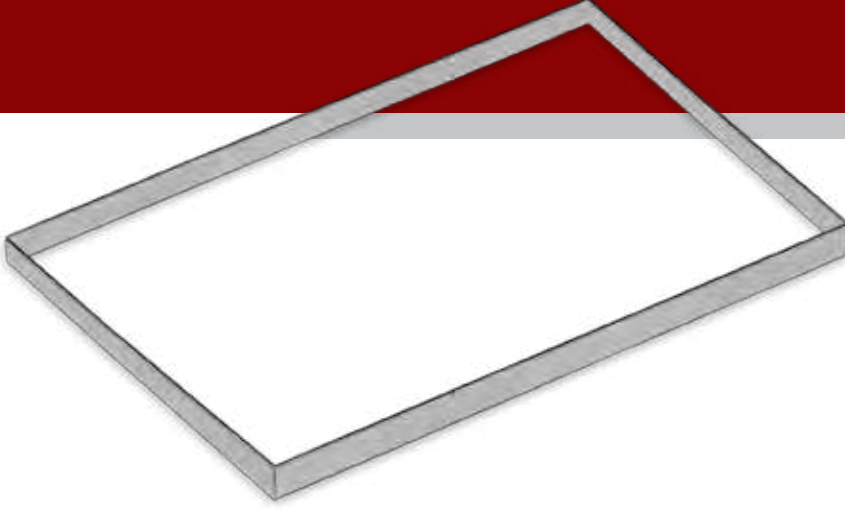
Paslanmaz Alt Bazalar
Stainless Steel Box Spring

Kod Code	Ürün Adı Description	Fiyatı Price Euro
EMP.PLS.9SBP240	Paslanmaz Alt Bazalar - 240 cm Stainless Steel Box Spring - 240 cm	550

Kod Code	Ürün Adı Description	Fiyatı Price Euro
EMP.PLS.9SBP280	Paslanmaz Alt Bazalar - 280 cm Stainless Steel Box Spring - 280 cm	650

Kod Code	Ürün Adı Description	Fiyatı Price Euro
EMP.PLS.9SBP320	Paslanmaz Alt Bazalar - 320 cm Stainless Steel Box Spring - 320 cm	750

Kod Code	Ürün Adı Description	Fiyatı Price Euro
EMP.PLS.9SBP360	Paslanmaz Alt Bazalar - 360 cm Stainless Steel Box Spring - 360 cm	850

Kod Code	Ürün Adı Description	Fiyatı Price Euro
EMP.PLS.9SBP400	Paslanmaz Alt Bazalar - 400 cm Stainless Steel Box Spring - 400 cm	950

Fırınlar
Ovens



empero@empero.com.tr



Plus Fırınlar
Plus Ovens

Plus Konveksiyonlu Fırınlar (Gazlı) / Plus Convection Ovens (Gas)

Plus Konveksiyonlu Fırınlar (Gazlı) / Plus Convection Ovens (Gas)

Plus Konveksiyonlu Fırınlar (Elektrikli) / Plus Convection Ovens (Electric)

Plus Konveksiyonlu Fırınlar (Elektrikli) / Plus Convection Ovens (Electric)

Plus Konveksiyonlu Fırınlar (Gazlı)
Plus Convection Ovens (Gas)

Kod Code	Ürün Adı Description	Ebatlar Dimension mm			Ağırlık Weight kg	Net Net m ³	Güç Power kw	Kapasite Capacity	Fiyatı Price Euro
		a	b	c					
EMP.GKF-10	Plus Konveksiyonlu Fırınlar-Gazlı Plus Convection Ovens-Gas	1000	1000	1100	120	1.1	27,2 Kw 380	10 GN-1/1	4.600
EMP. GKF-20	Plus Konveksiyonlu Fırınlar-Gazlı Plus Convection Ovens-Gas	1120	1070	1100	130	1.3	27,2 Kw 380	20 GN-1/1 / 10 GN-2/1	5.300
EMP.AS-10	EMP.PLS-G.10 Alt Stand EMP.PLS-G.10 Bottom Stand	1060	910	640	34	0.61			400
EMP.AS-20	EMP.PLS-G 20 Alt Stand EMP.PLS-G 20 Bottom Stand	1180	980	640	32	0.74			500

Kod Code	Gaz Tüketim Değeri Gas Consumption Ng	Gaz Tüketim Değeri Gas Consumption Lpg
EMP.GKF-10	2,8 m3/h	2,1 kg/h
EMP. GKF-20	2,8 m3/h	2,1 kg/h

Tüm modellerde tepsi kitleri
fiyata dahildir.

Tray kits are included in the
price for each model.



Su geçirmez touch kontrol paneli
Water proof touch panel control

Türkçe

PLUS KONVEKSİYONLU FIRINLAR (GAZLI)

- 7 inç renkli LCD ekran kontrol paneli.
- Harici bellek ile hafızaya yemek menüsü yükleyebilme özelliği.
- 99 çeşit program hafıza kapasitesi.
- Ekran üzerinden yemek ismi tanımlama özelliği.
- Manuel veya otomatik nemlendirme özelliği.
- Ekran üzerinden kullanım kılavuzuna ulaşabilme özelliği.
- Ayarlanabilir pişirme süresi ve dijital göstergesi.
- 0° C- 300° C arasında ayarlanabilir pişirme sıcaklığı ve dijital göstergesi.
- 360° C lik limit termostat.
- PID sistemi ve PWM tekniği ile hassas ısı kontrolü.
- Paslanmaz çelik kapalı sistem ısı transfer boruları.
- Lpg ve Ng ile çalışabilme özelliği.
- Fırın içi temizlik duş sprey ünitesi.
- 2 hızlı paslanmaz çelik fan.
- Çift yöne dönebilen fan ile eşit ısı dağılımı.
- Silikon contalı temperlenmiş cam.
- Kolay temizlik imkanı sağlayan açılabilir iç cam.
- Sensörlü kapı sistemi.
- Paslanmaz çelik gövde.

English

PLUS CONVECTION OVENS (GAS)

- 7 inch touch screen LCD control panel.
- Illustrated food menu upload option through external memory.
- 99 different kind of programme upload options.
- Food name defining option through touch screen.
- Manual and periodic steamer.
- User manual accessibility through touch screen.
- Adjustable cooking time.
- Adjustable cooking temperature between 0° C- 300° C
- Safety thermostat for overheating protection (360° C).
- Sensitive heating control through PID system and PWM technic.
- Stainless steel heat exchanger sealed system pipes.
- Lpg or Natural Gas.
- Retractable shower.
- 2 speed stainless steel fan.
- Dual direction fan provides homogenous heat distribution.
- Silicone sealed tempered glass.
- Easy-access interior glass in order to provide cleaning.
- Door switch system.
- Stainless steel body.

Plus Konveksiyonlu Fırınlar (Gazlı) Plus Convection Ovens (Gas)



Kod Code	Ürün Adı Description	Ebatlar Dimension mm			Ağırlık Weight kg	Net Net m³	Güç Power kw	Kapasite Capacity	Fiyatı Price Euro
		a	b	c					
EMP.GKF.40	Plus Konveksiyonlu Fırınlar-Gazlı Plus Convection Ovens-Gas	1120x1070x1885			250	2.25	54,4 Kw 380 V	40 GN-1/1 / 20 GN-2/1	7.700
EMP.TA.12-40X60	Patisserie Tepsi Taşıma Arabası ve Tepsi Kiti Patisserie Tray Carrying Trolley and Tray Kit	670x911x1746			60	1.06		12x(40x60)	850
EMP.TA-12.Y	Tepsi Taşıma Arabası ve Tepsi Kiti Tray Carrying Trolley and Tray Kit	670x911x1746			60	1.06		24 GN-1/1 / 12 GN-2/1	850
EMP.TA-16.Y	Tepsi Taşıma Arabası ve Tepsi Kiti Tray Carrying Trolley and Tray Kit	670x911x1746			60	1.06		32 GN-1/1 / 16 GN-2/1	850
EMP.TA-20.Y	Tepsi Taşıma Arabası ve Tepsi Kiti Tray Carrying Trolley and Tray Kit	670x911x1746			60	1.06		40 GN-1/1 / 20 GN-2/1	850

Türkçe

PLUS KONVEKSİYONLU FIRINLAR (GAZLI)

- 7 inç renkli LCD ekran kontrol paneli.
- Harici bellek ile hafızaya yemek menüsü yükleyebilme özelliği.
- 99 çeşit program hafıza kapasitesi.
- Ekran üzerinden yemek ismi tanımlama özelliği.
- Manuel veya otomatik nemlendirme özelliği.
- Ekran üzerinden kullanım kılavuzuna ulaşabilme özelliği.
- Ayarlanabilir pişirme süresi ve dijital göstergesi.
- 0° C- 300° C arasında ayarlanabilir pişirme sıcaklığı ve dijital göstergesi.
- 360° C lik limit termostat.
- PID sistemi ve PWM tekniği ile hassas ısı kontrolü.
- Paslanmaz çelik kapalı sistem ısı transfer boruları.
- Lpg ile Ng ile çalışabilme özelliği.
- Fırın içi temizlik duş sprej ünitesi.
- 2 hızlı paslanmaz çelik fan.
- Çift yöne dönebilen fan ile eşit ısı dağılımı.
- Silikon contalı temperlenmiş cam.
- Kolay temizlik imkanı sağlayan açılabilir iç cam.
- Sensörlü kapı sistemi.
- Paslanmaz çelik gövde.

English

PLUS CONVECTION OVENS (GAS)

- 7 inch touch screen LCD control panel.
- Illustrated food menu upload option through external memory.
- 99 different kind of programme upload options.
- Food name defining option through touch screen.
- Manual and periodic steamer.
- User manuel accessibility through touch screen.
- Adjustable cooking time.
- Adjustable cooking temperature between 0° C- 300° C
- Safety thermostat for overheating protection (360° C).
- Sensitive heating control through PID system and PWM technic.
- Stainless steel heat exchanger sealed system pipes.
- Lpg or Natural Gas.
- Retractable shower.
- 2 speed stainless steel fan.
- Dual direction fan provides homogenous heat distribution.
- Silicone sealed tempered glass.
- Easy-access interior glass in order to provide cleaning.
- Door switch system.
- Stainless steel body.



EMP.TA-20.Y

Kod Code	Gaz Tüketim Değeri Gas Consumption Ng	Gaz Tüketim Değeri Gas Consumption Lpg
EMP.GKF.40	5,7 m³/h	4,2 kg/h

- Unlu mamüller pişirmek için EMP.TA.12-40x60 tepsi taşıma arabasını ve tepsi kitini kullanınız.

- Please use EMP.TA.12-40X60 patisserie tray carrying trolley and tray kit in purpose of cooking bakery products

- Bir adet 40GN-1/1 tepsi taşıma arabasıve tepsi kiti fiyata dahildir.

- One piece of 40GN-1/1 tray carrying trolley and tray kit is included in the price



Su geçirmez touch kontrol paneli
Water proof touch panel control

Plus Konveksiyonlu Fırınlar (Elektrikli)
Plus Convection Ovens (Electric)



EMP.EKF-6
Konveksiyonlu Fırın - Elektrikli
Convection Oven - Electrical

Kod Code	Ürün Adı Description	Ebatlar Dimension mm			Ağırlık Weight kg	Net Net m³	Güç Power kw	Kapasite Capacity	Fiyatı Price Euro
		a	b	c					
EMP.EKF-6	Konveksiyonlu Fırın - Elektrikli Convection Oven - Electrical	800x855x700			85	0.47	9 Kw - 380 V	6 GN-1/1	2.100
EMP.EKF-10	Plus Konveksiyonlu Fırınlar - Elektrikli Plus Convection Ovens - Electrical	1000x1000x1100			135	1.1	15 Kw 380V 3-50 Hz	10 GN-1/1	4.600
EMP.EKF-20	Plus Konveksiyonlu Fırınlar - Elektrikli Plus Convection Ovens - Electrical	1120x1070x1500			130	1.3	25 Kw 380V 3-50 Hz	20 GN-1/1 / 10 GN-2/1	5.300
EMP.AS-10	EMP.PLS-E.10 Alt Stand EMP.PLS-E.10 Bottom Stand	1060x910x640			28	0.61			400
EMP.AS-20	EMP.PLS-E 20 Alt Stand EMP.PLS-E 20 Bottom Stand	1180x980x640			32	0.74			500
EMP.ASK-6	EMP.EKF-6 Alt Stand EMP.EKF-6 Bottom Stand	865x815x850			24	0.60			300

Kod Code	Elektrik Girişi Electric Input V	Kablo Kesiti Cable Cross Section mm²
EMP.EKF-10	380	5x6
EMP.EKF-20	380	5x6
EMP.EKF-6	380	5x2.5

Tüm modellerde tepsi kitleri
fiyata dahildir.

Tray kits are included in the
price for each model.



Su geçirmez touch kontrol paneli
Water proof touch panel control

Türkçe

PLUS KONVEKSİYONLU FIRINLAR (ELEKTRİKLİ)

- 7 inç renkli LCD ekran kontrol paneli.
- Harici bellek ile hafızaya yemek menüsü yükleyebilme özelliği.
- 99 çeşit program hafıza kapasitesi.
- Ekran üzerinden yemek ismi tanımlama özelliği.
- Manuel veya otomatik nemlendirme özelliği.
- Ekran üzerinden kullanım kılavuzuna ulaşabilme özelliği.
- Ayarlanabilir pişirme süresi ve dijital göstergesi.
- 0° C- 300° C arasında ayarlanabilir pişirme sıcaklığı ve dijital göstergesi.
- 360° C lik limit termostat.
- PID sistemiyle hassas ısı kontrolü. (SSR rölesi)
- Fırın içi temizlik duş sprey ünitesi.
- 2 hızlı paslanmaz çelik fan.
- Çift yöne dönebilen fan ile eşit ısı dağılımı.
- Silikon contalı temperlenmiş cam.
- Kolay temizlik imkanı sağlayan açılabilir iç cam.
- Sensörlü kapı sistemi.
- Paslanmaz çelik gövde.

EMP.EKF-6

- Termostatik sıcaklık kontrol ayarı.
- Dijital kontrollü pişirme süresi ve dijital kontrollü pişirme sıcaklığı.
- Çift yöne dönebilen fan ile eşit ısı dağılımı.
- Manuel buhar verme.
- Silikon contalı temperlenmiş cam.
- Sensörlü kapı sistemi.
- Paslanmaz çelik gövde.

English

PLUS CONVECTION OVENS (ELECTRIC)

- 7 inch touch screen LCD control panel.
- Illustrated food menu upload option through external memory.
- 99 different kind of programme upload options.
- Food name defining option through touch screen.
- Manual and periodic steamer.
- User direction accessibility through touch screen.
- Adjustable cooking time.
- Adjustable cooking temperature between 0° C- 300° C
- Safety thermostat for overheating protection (360° C).
- PID system provide sensitive heating (SSR relay)
- Retractable shower.
- 2 speed stainless steel fan.
- Dual direction fan provides homogenous heat distribution.
- Silicone sealed tempered glass.
- Easy-access interior glass in order to provide cleaning.
- Door switch system.
- Stainless steel body.

EMP.EKF-6

- Thermostatic heating control setting.
- Digital controlled cooking time and temperature.
- Dual direction fan provides homogenous heat distribution.
- Manual steamer.
- Silicone sealed tempered glass.
- Switch system on the door.
- Stainless steel body.

Plus Konveksiyonlu Fırınlar (Elektrikli)
Plus Convection Ovens (Electric)

Kod Code	Ürün Adı Description	Ebatlar Dimension mm			Ağırlık Weight kg	Net Net m ²	Güç Power kw	Kapasite Capacity	Fiyatı Price Euro
		a	b	c					
EMP.EKF-40	Plus Konveksiyonlu Fırınlar - Elektrikli Plus Convection Ovens - Electrical	1080	1070	1885	250	2.25	50 Kw 380V 3-50 Hz	40 GN-1/1 / 20 GN-2/1	7.900
EMP.TA.12-40X60	Patisserie Tepsi Taşıma Arabası ve Tepsi Kiti Patisserie Tray Carrying Trolley and Tray Kit	670	911	1746	60	1.06		12x(40x60)	850
EMP.TA-12.Y	Tepsi Taşıma Arabası ve Tepsi Kiti Tray Carrying Trolley and Tray Kit	670	911	1746	60	1.06		24 GN-1/1 / 12 GN-2/1	850
EMP.TA-16.Y	Tepsi Taşıma Arabası ve Tepsi Kiti Tray Carrying Trolley and Tray Kit	670	911	1746	60	1.06		32 GN-1/1 / 16 GN-2/1	850
EMP.TA-20.Y	Tepsi Taşıma Arabası ve Tepsi Kiti Tray Carrying Trolley and Tray Kit	670	911	1746	60	1.06		40 GN-1/1 / 20 GN-2/1	850

Türkçe
PLUS KONVEKSİYONLU FIRINLAR (ELEKTRİKLİ)

- 7 inç renkli LCD ekran kontrol paneli.
- Harici bellek ile hafızaya yemek menüsü yükleyebilme özelliği.
- 99 çeşit program hafıza kapasitesi.
- Ekran üzerinden yemek ismi tanımlama özelliği.
- Manuel veya otomatik nemlendirme özelliği.
- Ekran üzerinden kullanım kılavuzuna ulaşabilme özelliği.
- Ayarlanabilir pişirme süresi ve dijital göstergesi.
- 0° C- 300° C arasında ayarlanabilir pişirme sıcaklığı ve dijital göstergesi.
- 360° C lik limit termostat.
- PID sistemiyle hassas ısı kontrolü. (SSR röleli)
- Fırın içi temizlik duş sprej ünitesi.
- 2 hızlı paslanmaz çelik fan.
- Çift yöne dönebilen fan ile eşit ısı dağılımı.
- Silikon contalı temperlenmiş cam.
- Kolay temizlik imkanı sağlayan açılabilir iç cam.
- Sensörlü kapı sistemi.
- Paslanmaz çelik gövde.

English
PLUS CONVECTION OVENS (ELECTRIC)

- 7 inch touch screen LCD control panel.
- Illustrated food menu upload option through external memory.
- 99 different kind of programme upload options.
- Food name defining option through touch screen.
- Manual and periodic steamer.
- User manual accessibility through touch screen.
- Adjustable cooking time.
- Adjustable cooking temperature between 0° C- 300° C
- Safety thermostat for overheating protection (360° C).
- PID system provide sensitive heating (SSR relay)
- Retractable shower.
- 2 speed stainless steel fan.
- Dual direction fan provides homogenous heat distribution.
- Silicone sealed tempered glass.
- Easy-access interior glass in order to provide cleaning.
- Door switch system.
- Stainless steel body.

Kod Code	Elektrik Girişi Electric Input V	Kablo Kesiti Cable Cross Section mm ²
EMP.EKF-40	380	5x10

- Unlu mamüller pişirmek için EMP.TA.12-40x60 tepsi taşıma arabasını ve tepsi kitini kullanınız.

- Please use EMP.TA.12-40X60 patisserie tray carrying trolley and tray kit in purpose of cooking bakery products

- Bir adet 40GN-1/1 tepsi taşıma arabasıve tepsi kiti fiyata dahildir.

- One piece of 40GN-1/1 tray carrying trolley and tray kit is included in the price



EMP.TA-20.Y



Su geçirmez touch kontrol paneli
Water proof touch panel control



supported by ANGELO PO

İthal Kombi Fırınlar
Imported Combi Ovens

Gazlı Kombi Fırınlar / Gas Combi Ovens

Gazlı Kombi Fırınlar / Gas Combi Ovens

Elektrikli Kombi Fırınlar / Electric Combi Ovens

Elektrikli Kombi Fırınlar / Electric Combi Ovens

Gazlı Kombi Fırınlar
Gas Combi Ovens

Kod Code	Ürün Adı Description	Ebatlar Dimension mm			Ağırlık Weight kg	Net Net m³	Güç Power kw	Yükleme Kapasite Loading Capacity porsiyon	Fiyatı Price Euro
		a	b	c					
EMPCBG6	Gazlı Kombi Fırınlar 6 Gn 1/1 Gas Combi Oven 6 Gn 1/1	920	874	730	185	1	13.5	85	8.900
EMPCBG6-AS	Alt Stand 6 Gn 1/1 Bottom Stand 6 Gn 1/1	740	850	700	25	0.45			300



Kod Code	Ürün Adı Description	Ebatlar Dimension mm			Ağırlık Weight kg	Net Net m³	Güç Power kw	Yükleme Kapasite Loading Capacity porsiyon	Fiyatı Price Euro
		a	b	c					
EMPCBG10	Gazlı Kombi Fırınlar 10 Gn 1/1 Gas Combi Oven 10 Gn 1/1	920	874	975	213	1.2	19.5	140	9.500
EMPCBG10-AS	Alt Stand 10 Gn 1/1 Bottom Stand 10 Gn 1/1	700	860	600	30	0.3			400

Tütsüleme Kiti
Smoking Kit

Kod Code	Ürün Adı Description	Ebatlar Dimension mm			Ağırlık Weight kg	Net Net m³	Güç Power kw	Fiyatı Price Euro
		a	b	c				
EMPPTK01	Tütsüleme Kiti Smoking Kit	230	355	120	5.2	0.01	0.15	785

Türkçe
GAZLI KOMBİ FIRINLAR

- 230 V. 50 Hz çalışma gücü.
- LPG ve NG ile çalışabilme özelliği.
- Pişirme sırasında enerji sarfiyatını düşüren ECO fonksiyonu.
- PLUS ekstra güç fonksiyonu (gaz).
- SC2 yarı otomatik yıkama.
- 99 programlı pişirme hafızası : 4 fazlı; 3 ısıtma, 4 düşük dereceli pişirme ve 1 delta T programı.
- Tek noktali pişirme probu.
- UR2 pişirme esnasında otomatik nem kontrolü.
- RDC ekonomik buhar jenerasyonu sistemi.
- Ters yönlü 2 kademeli AWC fan.
- Dijital kontrol.
- Manuel buhar enjeksiyonu.
- Alarmla uyarı verebilen arıza teşhis özelliği.
- IPX5 koruma derecesi.
- Çift temperli camlı kapı.
- 304 kalite paslanmaz dış gövde, 316 kalite fırın iç yapısı.
- Ergonomik kapı kulbu.
- Kapalı kapı ile fırın içi soğutma fonksiyonu.
- Pişirme başlangıç saatini ayarlayabilme özelliği.
- Set edilen ve ölçülen sıcaklık değerlerini ayrı ayrı gösterebilme özelliği.
- Düşük sıcaklıklı veya yüksek sıcaklıklı buhar üretebilme özelliği.

English
GAS COMBI OVENS

- 230 V. 50 Hz operation power.
- Lpg or Natural Gas.
- ECO function for consumption reduction in cooking.
- PLUS extra power function (gas).
- SC2 semi automatic washing.
- Cooking modes: manual or programmable selection, 99 programs with 4 phases of whom 7 are standard, 3 re-heating programs, 5 smoking, 4 Low Temperature and 1 Delta T.
- Single-point temperature core probe.
- UR2 automatic humidity control while cooking.
- RDC steam generator with low management cost.
- Automatic fan reverse AWC, 2 fan speeds.
- Digital controls.
- Manual steam injection.
- Self-diagnosis with malfunction alarms.
- IPX5 protection degree.
- Door double tempered glazing.
- AISI 304 stainless steel polished cooking chamber ,with AISI 316L (1,2 mm) top and bottom and rounded edges without joints.
- Handle with double handgrip, easier opening also with hands full.
- Automatic Cooling and Preheating.
- Start-up time selection.
- Display of set and current cooking values.
- Low temperature steam and Superheated steam.

Tüm modellerde tepsi kitleri fiyatlara dahildir.
Tray kits are included in the price for each model.

Gazlı Kombi Fırınlar
Gas Combi Ovens



Kod Code	Ürün Adı Description	Ebatlar Dimension mm			Ağırlık Weight kg	Net Net m³	Güç Power kw	Yükleme Kapasite Loading Capacity porsiyon	Fiyatı Price Euro
		a	b	c					
EMPCBG24	Gazlı Kombi Fırınlar 12 Gn 2/1 Gas Combi Oven 12 Gn 2/1	1178	1064	1722	283	2.9	32.5	335	12.000
EMPCBG24-AS	Alt Stand 12 Gn 2/1 Bottom Stand 12 Gn 2/1	1210	860	600	32	0.6			500



Kod Code	Ürün Adı Description	Ebatlar Dimension mm			Ağırlık Weight kg	Net Net m³	Güç Power kw	Yükleme Kapasite Loading Capacity porsiyon	Fiyatı Price Euro
		a	b	c					
EMPCBG40	Gazlı Kombi Fırınlar 40 Gn 1/1 Gas Combi Oven 40 Gn 1/1	1190	1074	1795	449	3.4	55.5	560	22.650
EMPCBG40. TA-16	Tepsi Taşıma Arabası ve Tepsi Kiti Tray Carrying Trolley and Tray Kit	716	927	1700	77	1.5		32 GN-1/1 16 GN-2/1	850
EMPCBG40. TA-20	Tepsi Taşıma Arabası ve Tepsi Kiti Tray Carrying Trolley and Tray Kit	716	927	1700	77	1.5		40 GN-1/1 20 GN-2/1	850



Tütsüleme Kiti
Smoking Kit

Kod Code	Ürün Adı Description	Ebatlar Dimension mm			Ağırlık Weight kg	Net Net m³	Güç Power kw	Fiyatı Price Euro
		a	b	c				
EMPTTK01	Tütsüleme Kiti Smoking Kit	230	355	120	5.2	0.01	0.15	785



Tüm modellerde tepsi kitleri
fiyatlara dahildir.
Tray kits are included in the
price for each model.

- Bir adet 40GN-1/1 tepsi taşıma
arabasıve tepsi kiti fiyata dahildir.

- One piece of 40GN-1/1 tray carrying
trolley and tray kit is included in the price

Türkçe

GAZLI KOMBİ FIRINLAR

- 230 V. 50 Hz çalışma gücü.
- LPG ve NG ile çalışabilme özelliği.
- Pişirme sırasında enerji sarfiyatını düşüren ECO fonksiyonu.
- PLUS ekstra güç fonksiyonu (gaz).
- SC2 yarı otomatik yıkama.
- 99 programlı pişirme hafızası : 4 fazlı; 3 ısıtma, 4 düşük dereceli pişirme ve 1 delta T programı.
- Tek noktali pişirme probu.
- UR2 pişirme esnasında otomatik nem kontrolü.
- RDC ekonomik buhar jenerasyonu sistemi.
- Ters yönlü 2 kademeli AWC fan.
- Dijital kontrol.
- Manuel buhar enjeksiyonu.
- Alarmla uyarı verebilen arıza teşhis özelliği.
- IPX5 koruma derecesi.
- Çift temperli camlı kapı.
- 304 kalite paslanmaz dış gövde, 316 kalite fırın iç yapısı.
- Ergonomik kapı kulbu.
- Kapalı kapı ile fırın içi soğutma fonksiyonu.
- Pişirme başlangıç saatini ayarlayabilme özelliği.
- Set edilen ve ölçülen sıcaklık değerlerini ayrı ayrı gösterebilme özelliği.
- Düşük sıcaklıklı veya yüksek sıcaklıklı buhar üretebilme özelliği.

English

GAS COMBI OVENS

- 230 V. 50 Hz operation power.
- Lpg or Natural Gas.
- ECO function for consumption reduction in cooking.
- PLUS extra power function (gas).
- SC2 semi automatic washing.
- Cooking modes: manual or programmable selection, 99 programs with 4 phases of whom 7 are standard, 3 re-heating programs, 5 smoking, 4 Low Temperature and 1 Delta T.
- Single-point temperature core probe.
- UR2 automatic humidity control while cooking.
- RDC steam generator with low management cost.
- Automatic fan reverse AWC, 2 fan speeds.
- Digital controls.
- Manual steam injection.
- Self-diagnosis with malfunction alarms.
- IPX5 protection degree.
- Door double tempered glazing.
- AISI 304 stainless steel polished cooking chamber, with AISI 316L (1,2 mm) top and bottom and rounded edges without joints.
- Handle with double handgrip, easier opening also with hands full.
- Automatic Cooling and Preheating.
- Start-up time selection.
- Display of set and current cooking values.
- Low temperature steam and Superheated steam.

Elektrikli Kombi Fırınlar
Electric Combi Ovens

Kod Code	Ürün Adı Description	Ebatlar Dimension mm			Ağırlık Weight kg	Net Net m³	Güç Power kw	Yükleme Kapasite Loading Capacity porsiyon	Fiyatı Price Euro
		a	b	c					
EMPCBE6	Elektrikli Kombi Fırınlar 6 Gn 1/1 Electric Gas Combi Oven 6 Gn 1/1	920	874	730	160	1	10.1	85	7.550
EMPCBE6-AS	Alt Stand 6 Gn 1/1 Bottom Stand 6 Gn 1/1	740	850	700	25	0.45			300



Kod Code	Ürün Adı Description	Ebatlar Dimension mm			Ağırlık Weight kg	Net Net m³	Güç Power kw	Yükleme Kapasite Loading Capacity porsiyon	Fiyatı Price Euro
		a	b	c					
EMPCBE10	Elektrikli Kombi Fırınlar 10 Gn 1/1 Electric Combi Oven 10 Gn 1/1	920	874	975	198	1.2	17.3	140	8.300
EMPCBE10-AS	Alt Stand 10 Gn 1/1 Bottom Stand 10 Gn 1/1	700	860	600	30	0.3			400

Tütsüleme Kiti
Smoking Kit

Kod Code	Ürün Adı Description	Ebatlar Dimension mm			Ağırlık Weight kg	Net Net m³	Güç Power kw	Fiyatı Price Euro
		a	b	c				
EMPTTK01	Tütsüleme Kiti Smoking Kit	230	355	120	5.2	0.01	0.15	785

Türkçe
ELEKTRİKLİ KOMBİ FIRINLAR

- 400 V, 50 Hz çalışma gücü.
- Pişirme sırasında enerji sarfiyatını düşüren ECO fonksiyonu.
- SC2 yarı otomatik yıkama.
- 99 programlı pişirme hafızası : 4 fazlı; 3 ısıtma, 4 düşük dereceli pişirme ve 1 delta T programı.
- Tek noktalı pişirme probu.
- UR2 pişirme esnasında otomatik nem kontrolü.
- RDC ekonomik buhar jenerasyonu sistemi.
- Ters yönlü 2 kademeli AWC fan.
- Dijital kontrol.
- Manuel buhar enjeksiyonu.
- Alarmla uyarı verebilen arıza teşhis özelliği.
- IPX5 koruma derecesi.
- Çift temperli camlı kapı.
- 304 kalite paslanmaz dış gövde, 316 kalite fırın iç yapısı.
- Ergonomik kapı kulbu.
- Kapalı kapı ile fırın içi soğutma fonksiyonu.
- Pişirme başlangıç saatini ayarlayabilme özelliği.
- Set edilen ve ölçülen sıcaklık değerlerini ayrı ayrı gösterebilme özelliği.
- Düşük sıcaklıklı veya yüksek sıcaklıklı buhar üretebilme özelliği.

English
ELECTRIC COMBI OVENS

- 400 V, 50 Hz operation power.
- ECO function for consumption reduction in cooking.
- SC2 semi automatic washing.
- Cooking modes: manual or programmable selection, 99 programs with 4 phases of whom 7 are standard, 3 re-heating programs, 5 smoking, 4 Low Temperature and 1 Delta T.
- Single-point temperature core probe.
- UR2 automatic humidity control while cooking.
- RDC steam generator with low management cost.
- Automatic fan reverse AWC, 2 fan speeds.
- Digital controls.
- Manual steam injection.
- Self-diagnosis with malfunction alarms.
- IPX5 protection degree.
- Door double tempered glazing.
- AISI 304 stainless steel polished cooking chamber ,with AISI 316L (1,2 mm) top and bottom and rounded edges without joints.
- Handle with double handgrip, easier opening also with hands full.
- Automatic Cooling and Preheating.
- Start-up time selection.
- Display of set and current cooking values.
- Low temperature steam and Superheated steam.

Tüm modellerde tepsi kitleri fiyatlara dahildir.
Tray kits are included in the price for each model.

Elektrikli Kombi Fırınlar
Electric Combi Ovens

Kod Code	Ürün Adı Description	Ebatlar Dimension mm			Ağırlık Weight kg	Net Net m³	Güç Power kw	Yükleme Kapasite Loading Capacity porsiyon	Fiyatı Price Euro
		a	b	c					
EMPCBE24	Elektrikli Kombi Fırınlar 12 Gn 2/1 Electric Combi Oven 12 Gn 2/1	1178	1064	1722	278	2.9	27.5	335	10.250
EMPCBE24-AS	Alt Stand 12 Gn 2/1 Bottom Stand 12 Gn 2/1	1210	860	600	32	0.6			500



Kod Code	Ürün Adı Description	Ebatlar Dimension mm			Ağırlık Weight kg	Net Net m³	Güç Power kw	Yükleme Kapasite Loading Capacity porsiyon	Fiyatı Price Euro
		a	b	c					
EMPCBE40	Elektrikli Kombi Fırınlar 40 Gn 1/1 Electric Combi Oven 40 Gn 1/1	1190	1074	1795	449	3.4	55.5	560	18.500
EMPCBE40. TA-16	Tepsi Taşıma Arabası ve Tepsi Kiti Tray Carrying Trolley and Tray Kit	716	927	1700	77	1.5		32 GN-1/1 16 GN-2/1	850
EMPCBE40. TA-20	Tepsi Taşıma Arabası ve Tepsi Kiti Tray Carrying Trolley and Tray Kit	716	927	1700	77	1.5		40 GN-1/1 20 GN-2/1	850

Tütsüleme Kiti
Smoking Kit

Kod Code	Ürün Adı Description	Ebatlar Dimension mm			Ağırlık Weight kg	Net Net m³	Güç Power kw	Fiyatı Price Euro
		a	b	c				
EMPTTK01	Tütsüleme Kiti Smoking Kit	230	355	120	5.2	0.01	0.15	785



Tüm modellerde tepsi kitleri fiyatlara dahildir.
Tray kits are included in the price for each model.

- Bir adet 40GN-1/1 tepsi taşıma arabasıve tepsi kiti fiyata dahildir.

- One piece of 40GN-1/1 tray carrying trolley and tray kit is included in the price

Türkçe

ELEKTRİKLİ KOMBİ FIRINLAR

- 400 V. 50 Hz çalışma gücü.
- Pişirme sırasında enerji sarfiyatını düşüren ECO fonksiyonu.
- SC2 yarı otomatik yıkama.
- 99 programlı pişirme hafızası : 4 fazlı; 3 ısıtma, 4 düşük dereceli pişirme ve 1 delta T programı.
- Tek noktalı pişirme probu.
- UR2 pişirme esnasında otomatik nem kontrolü.
- RDC ekonomik buhar jenerasyonu sistemi.
- Ters yönlü 2 kademeli AWC fan.
- Dijital kontrol.
- Manuel buhar enjeksiyonu.
- Alarmla uyarı verebilen arıza teşhis özelliği.
- IPX5 koruma derecesi.
- Çift temperli camlı kapı.
- 304 kalite paslanmaz dış gövde, 316 kalite fırın iç yapısı.
- Ergonomik kapı kulbu.
- Kapalı kapı ile fırın içi soğutma fonksiyonu.
- Pişirme başlangıç saatini ayarlayabilme özelliği.
- Set edilen ve ölçülen sıcaklık değerlerini ayrı ayrı gösterebilme özelliği.
- Düşük sıcaklıklı veya yüksek sıcaklıklı buhar üretebilme özelliği.

English

ELECTRIC COMBI OVENS

- 400 V. 50 Hz operation power.
- ECO function for consumption reduction in cooking.
- SC2 semi automatic washing.
- Cooking modes: manual or programmable selection, 99 programs with 4 phases of whom 7 are standard, 3 re-heating programs, 5 smoking, 4 Low Temperature and 1 Delta T.
- Single-point temperature core probe.
- UR2 automatic humidity control while cooking.
- RDC steam generator with low management cost.
- Automatic fan reverse AWC, 2 fan speeds.
- Digital controls.
- Manual steam injection.
- Self-diagnosis with malfunction alarms.
- IPX5 protection degree.
- Door double tempered glazing.
- AISI 304 stainless steel polished cooking chamber ,with AISI 316L (1,2 mm) top and bottom and rounded edges without joints.
- Handle with double handgrip, easier opening also with hands full.
- Automatic Cooling and Preheating.
- Start-up time selection.
- Display of set and current cooking values.
- Low temperature steam and Superheated steam.



Fırınlar (Pastane) Ovens (Patisserie)

Konveksiyonlu Patisserie Fırınları (Elektrikli) / Convection Patisserie Ovens (Electric)

Plus Konveksiyonlu Patisserie Fırınları (Gazlı) / Plus Convection Patisserie Ovens (Gas)

Plus Konveksiyonlu Patisserie Fırınları (Elektrikli) / Plus Convection Patisserie Ovens (Electric)

Kombi Fırın (Büyük - Küçük) Model / Combi Oven (Big - Small) Model

Elektrikli Modüler Fırın (Dijital Kumandalı) / Electric Deck Oven (Digital Control)

Gazlı Modüler Fırın (Dijital Kumandalı) / Gas Deck Oven (Digital Control)

Profesyonel Mayalandırma Kabini / Proofer

Döner Tabanlı Elektrikli Pizza Fırını / Rotating Electric Pizza Oven

Döner Tabanlı Gazlı Pizza Fırını / Rotating Gas Pizza Oven

Pizza Fırınları-Tek Katlı (Dijital Isı Göstergeli) / Single Layer Pizza Ovens (Digital Temperature Indicator)

Pizza Fırınları-Çift Katlı (Dijital Isı Göstergeli) / Two Layers Pizza Ovens (Digital Temperature Indicator)

Gold Midi ve Maxi Pizza Fırınları (Elektrikli) / Gold Midi and Maxi Pizza Ovens (Electrical)

Pizza Fırınları (Gazlı) / Pizza Ovens (Gas)

Konveksiyonlu Patisserie Fırınları (Elektrikli) Convection Patisserie Ovens (Electric)



EMP.PFE4-U
Konveksiyonlu Patisserie Fırını-Üstten Açılır
Convection Patisserie Ovens-Top Opening



EMP.PFE4-Y
Konveksiyonlu Patisserie Fırını-Yana Açılır
Convection Patisserie Ovens-Side Opening

Kod Code	Ürün Adı Description	Ebatlar Dimension mm			Ağırlık Weight kg	Net Net m³	Güç Power kw	Kapasite Capacity	Fiyatı Price Euro
		a	b	c					
EMP.PFE4-U	Konveksiyonlu Patisserie Fırını-Üstten Açılır - Elektrikli Convection Patisserie Ovens-Top Opening - Electrical	800	845	560	75	0.36	6 Kw- 220 V	4-40x60	1.600
EMP.PFE4-Y	Konveksiyonlu Patisserie Fırını-Yana Açılır - Elektrikli Convection Patisserie Ovens-Side Opening - Electrical	800	855	565	75	0.4	6 Kw - 220 V	4-40x60	1.800
EMP.PFE6-Y	Konveksiyonlu Patisserie Fırını-Yana Açılır - Elektrikli Convection Patisserie Ovens-Side Opening - Electrical	800	855	700	85	0.5	9 Kw- 380 V	6-40x60	2.100
EMP.MF4-6	Mayalandırma Kabini Fermentation Cabinet	800	790	850	65	0.6	1.2	8-40x60	750

Kod Code	Elektrik Girişi Electric Input v	Kablo Kesiti Cable Cross Section mm²
EMP.PFE4-U	220	5x2,5
EMP.PFE4-Y	220	5x2,5
EMP.PFE6-Y	380	5x2,5
EMP.MF4-6	220	3x2,5

Türkçe

KONVEKSİYONLU PATISSERIE FIRINLARI (ELEKTRİKLİ)

- Termostatik sıcaklık kontrol ayarı.
- Dijital kontrollü pişirme süresi ve dijital kontrollü pişirme sıcaklığı.
- Çift yöne dönebilen fan ile eşit ısı dağılımı.
- Silikon contalı temperlenmiş cam.
- Manuel buhar verme.
- Sensörlü kapı sistemi.
- Paslanmaz çelik gövde.

English

CONVECTION PATISSERIE OVENS (ELECTRIC)

- Thermostatic electronic heating control setting.
- Digital controlled cooking time and temperature.
- Dual direction fan provides homogenous heatdistribution.
- Silicon sealed tempered glass.
- Manuel steamer.
- Switch system on the door.
- Stainless steel body.



Su geçirmez touch kontrol paneli
Water proof touch panel control



EMP.MF4-6
Mayalandırma Kabini
Fermentation Cabinet



Plus Konveksiyonlu Patisserie Fırınları (Gazlı)

Plus Convection Patisserie Ovens (Gas)



Kod Code	Ürün Adı Description	Ebatlar Dimension mm			Ağırlık Weight kg	Net Net m³	Güç Power kw	Kapasite Capacity	Fiyatı Price Euro
		a	b	c					
EMP.PFG8	P.Konveksiyonlu Patisserie Fırını - Gazlı P.Convection Patisserie Oven - Gas	1000	1000	1310	220	1.31	27.2 Kw 380 V 3-50 Hz	8-40x60	4.850
EMP.MF8	Mayalandırma Kabini Fermentation Cabinet	967	882	853	110	0.72	1.2 Kw 220 V 3-50 Hz	8-40x60	750
EMP.AS8	Alt Stand Bottom Stand	967	882	853	28	0.72			400

Kod Code	Gaz Tüketim Değeri Gas Consumption Ng	Gaz Tüketim Değeri Gas Consumption Lpg
EMP.PFG8	2,9 m³/h	2,17 kg/h

Türkçe

PLUS KONVEKSİYONLU PATISSERIE FIRINLARI (GAZ)

- 7 inç renkli LCD ekran kontrol paneli.
- Harici bellek ile hafızaya menü yükleyebilme özelliği.
- 99 çeşit program hafıza kapasitesi.
- Ekran üzerinden program ismi tanımlama özelliği.
- Manuel veya otomatik nemlendirme özelliği.
- Ekran üzerinden kullanım kılavuzuna ulaşabilme özelliği.
- Ayarlanabilir pişirme süresi ve dijital göstergesi.
- 0° C- 300° C arasında ayarlanabilir pişirme sıcaklığı ve dijital göstergesi.
- 360° C lik limit termostat.
- PID sistemi ve PWM tekniği ile hassas ısı kontrolü.
- Paslanmaz çelik kapalı sistem ısı transfer boruları.
- Lpg ve Ng ile çalışabilme özelliği.
- Fırın içi temizlik duş sprey ünitesi.
- 2 hızlı paslanmaz çelik fan.
- Çift yöne dönebilen fan ile eşit ısı dağılımı.
- Silikon contalı temperlenmiş cam.
- Kolay temizlik imkanı sağlayan açılabilir iç cam.
- Sensörlü kapı sistemi.
- Paslanmaz çelik gövde.

English

PLUS CONVECTION PATISSERIE OVENS (GAS)

- 7 inch touch screen LCD control panel.
- Illustrated menu upload option through external memory.
- 99 different kind of programme upload options.
- Programme name defining option through touch screen.
- Manual and periodic steamer.
- User manual accessibility through touch screen.
- Adjustable cooking time.
- Adjustable cooking temperature between 0° C- 300° C
- Safety thermostat for overheating protection (360° C).
- Sensitive heating control through PID system and PWM technic.
- Stainless steel heat exchanger sealed system pipes.
- Lpg or Natural Gas.
- Retractable shower.
- 2 speed stainless steel fan.
- Dual direction fan provides homogenous heat distribution.
- Silicone sealed tempered glass.
- Easy-access interior glass in order to provide cleaning.
- Door switch system.
- Stainless steel body.



Su geçirmez touch kontrol paneli
Water proof touch panel control

Plus Konveksiyonlu Patisserie Fırınları (Elektrikli)
Plus Convection Patisserie Ovens (Electric)

Kod Code	Ürün Adı Description	Ebatlar Dimension mm			Ağırlık Weight kg	Net Net m³	Güç Power kw	Kapasite Capacity	Fiyatı Price Euro
		a	b	c					
EMP.PFE8	P.Konveksiyonlu Patisserie Fırını - Elektrikli P.Convection Patisserie Oven - Electrical	1000	1000	1310	202	1.31	18 Kw 380 V 3-50 Hz	8-40x60	4.850
EMP.MF8	Mayalandırma Kabini Fermentation Cabinet	967	882	853	62	0.72	1.2 Kw 220 V 3-50 Hz	8-40x60	750
EMP.AS8	Alt Stand Bottom Stand	967	882	853	28	0.72			400

Kod Code	Elektrik Girişi Electric Input V	Kablo Kesiti Cable Cross Section mm²
EMP.PFE8	380	5x6
EMP.MF8	220	3x2,5

Türkçe

PLUS KONVEKSİYONLU PATİSSERİE FIRINLAR
(ELEKTRİKLİ)

- 7 inç renkli LCD ekran kontrol paneli.
- Harici bellek ile hafızaya menü yükleyebilme özelliği.
- 99 çeşit program hafıza kapasitesi.
- Ekran üzerinden program ismi tanımlama özelliği.
- Manuel veya otomatik nemlendirme özelliği.
- Ekran üzerinden kullanım kılavuzuna ulaşabilme özelliği.
- Ayarlanabilir pişirme süresi ve dijital göstergesi.
- 0° C- 300° C arasında ayarlanabilir pişirme sıcaklığı ve dijital göstergesi.
- 360° C lik limit termostat.
- PID sistemiyle hassas ısı kontrolü. (SSR röleli)
- Fırın içi temizlik duş sprej ünitesi.
- 2 hızlı paslanmaz çelik fan.
- Çift yöne dönebilen fan ile eşit ısı dağılımı.
- Silikon contalı temperlenmiş cam.
- Kolay temizlik imkanı sağlayan açılabilir iç cam.
- Sensörlü kapı sistemi.
- Paslanmaz çelik gövde.

English

PLUS CONVECTION PATISSERIE OVENS
(ELECTRIC)

- 7 inch touch screen LCD control panel.
- Illustrated menu upload option through external memory.
- 99 different kind of programme upload options.
- Programme name defining option through touch screen.
- Manual and periodic steamer.
- User manuel accessibility through touch screen.
- Adjustable cooking time.
- Adjustable cooking temperature between 0° C- 300° C
- Safety thermostat for overheating protection (360° C).
- PID system provide sensitive heating (SSR relay)
- Retractable shower.
- 2 speed stainless steel fan.
- Dual direction fan provides homogenous heat distribution.
- Silicone sealed tempered glass.
- Easy-access interior glass in order to provide cleaning.
- Door switch system.
- Stainless steel body.

Su geçirmez touch kontrol paneli
Water proof touch panel control

Kombi Fırın (Büyük - Küçük) Model Combi Oven (Big - Small Model)



Su geçirmez touch kontrol paneli
Water proof touch panel control

Kod Code	Ürün Adı Description	Ebatlar Dimension mm			Ağırlık Weight kg	Net Net m ³	Güç Power kw	Fiyatı Price Euro
		a	b	c				
EMP.PFE.4+5-Y-B	Kombi Fırın Büyük Model Combi Oven Big Model	1030	1151	1202	182	1.42	12 Kw	3.500
EMP.MF8-B	Mayalandırma Kabini Fermentation Cabinet	1030	984	850	90	0.86	1.2 Kw	1.000
EMP.PFE.4+5.Y-K	Kombi Fırın Küçük Model Combi Oven Small Model	1030	961	1202	162	1.19	10.5 Kw	3.200
EMP.MF8-K	Mayalandırma Kabini Fermentation Cabinet	1030	794	850	80	0.69	1.2 Kw	900

Türkçe

KOMBİ FIRIN BÜYÜK MODEL

- 12 Kw makine toplam gücü.
- Konveksiyonlu fırın için;400x600 mm 4 tepsi kapasitesi.
- Pizza fırını için ;400x600 mm 2 tepsi kapasitesi.
- Ø 250 mm'lik 7 adet pizza kapasitesi.
- Termostatik sıcaklık kontrol ayarı.
- Dijital kontrollü pişirme süresi ve dijital kontrollü pişirme sıcaklığı.
- Çift yöne dönebilen fan ile eşit ısı dağılımı.
- Silikon contalı temperlenmiş cam.
- Manuel buhar verme.
- Sensörlü kapı sistemi.
- Dijital iç sıcaklık göstergesi.
- Ayarlanabilir üst ve alt ısı verimleri.
- Paslanmaz çelik gövde.

KOMBİ FIRIN KÜÇÜK MODEL

- 10,5 Kw makine toplam gücü.
- Konveksiyonlu fırın için;400x600 mm 4 tepsi kapasitesi.
- Pizza fırını için ;400x600 mm 1 tepsi kapasitesi.
- Ø 250 mm'lik 5 adet pizza kapasitesi.
- Termostatik sıcaklık kontrol ayarı.
- Dijital kontrollü pişirme süresi ve dijital kontrollü pişirme sıcaklığı.
- Çift yöne dönebilen fan ile eşit ısı dağılımı.
- Silikon contalı temperlenmiş cam.
- Manuel buhar verme.
- Sensörlü kapı sistemi.
- Dijital iç sıcaklık göstergesi.
- Ayarlanabilir üst ve alt ısı verimleri.
- Paslanmaz çelik gövde.

English

COMBI OVEN BIG MODEL

- 12 Kw total power.
- Tray capacity for convection oven ; 4 trays of 400x600 mm
- Tray capacity for pizza oven; 2 tray of 400x600 mm
- Pizza capacity: 7 pieces Ø 250 mm
- Thermostatic electronic heating control setting.
- Digital controlled cooking time and temperature.
- Dual direction fan provides homogenous heat distributon
- Silicon sealed tempered glass.
- Manuel steamer.
- Switch system on the door.
- Digital interior temperature indicator.
- Adjustable top and bottom heating output.
- Stainless steel body.

COMBI OVEN SMALL MODEL

- 10,5 Kw total power.
- Tray capacity for convection oven ; 4 trays of 400x600 mm
- Tray capacity for pizza oven; 1 tray of 400x600 mm
- Pizza capacity:5 pieces Ø 250 mm
- Thermostatic electronic heating control setting.
- Digital controlled cooking time and temperature.
- Dual direction fan provides homogenous heat distributon.
- Silicon sealed tempered glass.
- Manuel steamer.
- Switch system on the door.
- Digital interior temperature indicator.
- Adjustable top and bottom heating output.
- Stainless steel body.



Elektrikli Modüler Fırın (Dijital Kumandalı)
Electric Deck Oven (Digital Control)



Kod Code	Ürün Adı Description	Ebatlar Dimension mm			İç Ebatlar Interior Dimensions mm	Ağırlık Weight kg	Net Net m³	Güç Power kw	Fiyatı Price Euro
		a	b	c					
EMP.3545-6	Elektrikli Modüler Fırın (Tek Kat) Deck Oven (Single Layer)	1800	1305	376	1234x925x247	279	0.88	14 Kw 380 V 3-50 Hz	4.400
EMP.3545-6D	Elektrikli Modüler Fırın Davlumbazı Hood	1800	1350	283		33	0.68		275
EMP.3545-6M	Elektrikli Modüler Fırın Mayalandırma Kabini Fermentation Cabinet	1800	1120	920	410x990x345	180	1.85	3 Kw 220 V 3-50 Hz	2.000
EMP.3545-6S	Elektrikli Modüler Fırın Alt Stand Bottom Stand	1800	1120	872		66	1.75		1.100
EMP.3545-6A	Elektrikli Modüler Fırın Ara Kat Middle Layer	1800	1120	300		23	0.60		650
EMP.3545-6B	Elektrikli Modüler Fırın Buhar Jenaratörü (Tek Kat İçin) Steam Generator (For Single Layer)	700	200	288			0.04	2,7 Kw 380 V 3-50 Hz	750

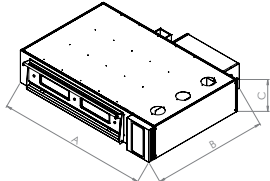

EMP.3545-6

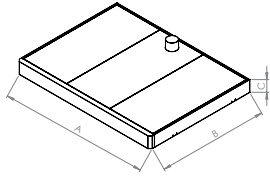

EMP.3545-6D

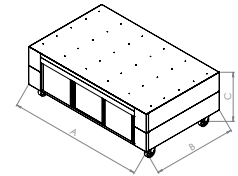

EMP.3545-6M



Türkçe

ELEKTRİKLİ MODÜLER FIRIN
(DİJİTAL KUMANDALI)

- 4.3 inç renkli LCD ekran kontrol paneli.
- Harici bellek ile hafızaya yemek menüsü yükleyebilme özelliği.
- 99 ayrı program özelliği.
- Ekran üzerinden yemek ismi tanımlama özelliği.
- Manuel veya otomatik nemlendirme özelliği.
- Ekran üzerinden kullanım kılavuzuna ulaşabilme özelliği.
- Ayarlanabilir pişirme süresi ve dijital göstergesi.
- 0° C- 400° C arasında ayarlanabilir pişirme sıcaklığı ve dijital göstergesi.
- 450° C lik limit termostat.
- PID sistemiyle hassas ısı kontrolü. (SSR rölesi)
- 14 Kw 380 V fırın gücü.
- 2.7 Kw opsiyonel buhar jenaratör gücü.
- 350 derece maksimum sıcaklık.
- 350x450 mm'lik 6 tepsi veya 400x600 mm'lik 4 tepsili fırın kapasitesi.
- 1225 mm x 920 mm fırın iç ölçüsü.
- Ayarlanabilir alt ve üst ısı sıcaklıkları.
- Eşit ısı dağılımı.
- Paslanmaz çelik boru rezistans.
- Paslanmaz çelik gövde.
- İsteğe göre tek, iki veya üç kat yapılabilir.

Mayalandırma Kabini

- 3 Kw güç.
- 1800x1120 mm ebat.
- 3x5 bölmeli. (400 mm x 600 mm)
- Ayrı ayrı ayarlanabilir ısı ve nem seviyeleri.

English

ELECTRIC DECK OVEN (DIGITAL CONTROL)

- 4.3 inch touch screen LCD control panel.
- Illustrated food menu upload option through external memory.
- 99 different cooking programme.
- Food name defining option through touch screen.
- Manual and periodic steamer.
- User manuel accessibility through touch screen.
- Adjustable cooking time.
- Adjustable cooking temperature between 0° C- 350° C
- Safety thermostat for overheating protection (400° C).
- PID system provide sensitive heating (SSR relay).
- Power:14 Kw 380 V
- Steam generator(optional) power:2.7 Kw
- Max temperature:350° C
- Capacity. 6 no's of 350x450 mm trays or 4 no's of 400x600 mm trays .
- Interior dimension:1225 mm x 920 mm
- Adjustable top and bottom heating output.
- Homogenous heat distribution.
- Stainless steel pipe resistance.
- Stainless steel body.
- According to demand single,double or triple layer options.

Fermentation Cabinet

- 3 Kw power.
- 1800x1120 mm dimension.
- 3x5 layers. (400 mm x 600 mm)
- Adjustable temperature and humidity levels.

Su geçirmez touch kontrol paneli
Water proof touch panel control



Gazlı Modüler Fırın (Dijital Kumandalı)

Gas Deck Oven (Digital Control)



Kod Code	Ürün Adı Description	Ebatlar Dimension mm			İç Ebatlar Interior Dimensions mm	Ağırlık Weight kg	Net Net m³	Güç Power kw	Fiyatı Price Euro
		a	b	c					
EMP.4060-3G	Gazlı Modüler Fırın (Tek Kat) - Taşlı Model Gas Deck Oven (Single Layer) - Stone Type	1900	1095	615	1230x650x220	310	1.28	25.5 Kw 220 V 3-50 Hz	4.750
EMP.4060-3G-P	Gazlı Modüler Fırın (Tek Kat) - Paslanmaz Model Gas Deck Oven (Single Layer) - Steel Type	1900	1095	615	1230x650x220	310	1.28	25.5 Kw 220 V 3-50 Hz	4.750
EMP.4060-3G-D	Gazlı Modüler Fırın Davlumbazı Hood	1900	1150	283		33	0.62		275
EMP.4060-3G-M	Gazlı Modüler Fırın Mayalandırma Kabini Fermantation Cabinet	1900	830	570	410x695x345	180	0.9	3 Kw 220 V 3-50 Hz	2.000
EMP.4060-3G-S	Gazlı Modüler Fırın Alt Stand Bottom Stand	1900	910	872		66	1.75		1.100
EMP.4060-3G-A	Gazlı Modüler Fırın Ara Kat Middle Layer	1900	1120	300		23	0.60		650
EMP.4060-3G-B	Gazlı Modüler Fırın Buhar Jenaratörü (Tek Kat İçin) Steam Generator (For Single Layer)	700	200	288			0.04	2,7 Kw 380 V 3-50 Hz	750

Türkçe

GAZLI MODÜLER FIRIN (DİJİTAL KUMANDALI)

- LPG ve NG ile çalışabilme özelliği.
- 4.3 inç renkli LCD ekran kontrol paneli.
- Harici bellek ile hafızaya yemek menüsü yükleyebilme özelliği.
- 99 ayrı program özelliği.
- Ekran üzerinden yemek ismi tanımlama özelliği.
- Manuel veya otomatik nemlendirme özelliği.
- Ekran üzerinden kullanım kılavuzuna ulaşabilme özelliği.
- Ayarlanabilir pişirme süresi ve dijital göstergesi.
- 0° C - 400° C arasında ayarlanabilir pişirme sıcaklığı ve dijital göstergesi.
- 450° C lik limit termostat.
- PID sistemiyle hassas ısı kontrolü. (SSR röleli)
- 25.5 Kw 220 V fırın gücü.
- 2.7 Kw opsiyonel buhar jenaratör gücü.
- 350 derece maksimum sıcaklık.
- 300x400 mm'lik 6 tepsi veya 400x600 mm'lik 3 tepsili fırın kapasitesi.
- 1230 mm x 650 mm fırın iç ölçüsü.
- Ayarlanabilir alt ve üst ısı sıcaklıkları.
- Eşit ısı dağılımı.
- Paslanmaz çelik boru rezistans.
- Paslanmaz çelik gövde.
- İsteğe göre tek, iki veya üç kat yapılabilir.

Mayalandırma Kabini

- 3 Kw güç.
- 1800x1120 mm ebat.
- 3x5 bölmeli. (400 mm x 600 mm)
- Ayrı ayrı ayarlanabilir ısı ve nem seviyeleri.

English

GAS DECK OVEN (DIGITAL CONTROL)

- Lpg or Natural Gas.
- 4.3 inch touch screen LCD control panel.
- Illustrated food menu upload option through external memory.
- 99 different cooking programme.
- Food name defining option through touch screen.
- Manual and periodic steamer.
- User manual accessibility through touch screen.
- Adjustable cooking time.
- Adjustable cooking temperature between 0° C- 350° C
- Safety thermostat for overheating protection (400° C).
- PID system provide sensitive heating (SSR relay)
- Power:25.5 Kw 220 V
- Steam generator(optional) power:2.7 Kw
- Max temperature:350° C
- Capacity. 6 no's of 300x400 mm trays or 3 no's of 400x600 mm trays.
- Interior dimension:1230 mm x 650 mm
- Adjustable top and bottom heating output.
- Homogenous heat distribution.
- Stainless steel pipe resistance.
- Stainless steel body.
- According to demand single,double or triple layer options.

Fermantation Cabinet

- 3 Kw power.
- 1800x1120 mm dimension.
- 3x5 layers. (400 mm x 600 mm)
- Adjustable temperature and humidity levels.

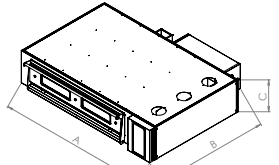

EMP.4060-3G

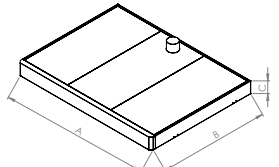

EMP.4060-3G-D

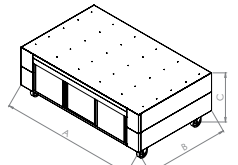

EMP.4060-3G-M



Su geçirmez touch kontrol paneli
Water proof touch panel control

Profesyonel Mayalandırma Kabini Proofer



EMP.MF.20

Kod Code	Ürün Adı Description	Ebatlar Dimension mm			Ağırlık Weight kg	Net Net m³	Güç Power kw	Kapasite Capacity	Fiyatı Price Euro
		a	b	c					
EMP.MF.20	Profesyonel Mayalandırma Kabini (Tek Cidarlı) Proofer (Single Jacket)	500x720x1800			80	0.7	1 Kw- 220 V	16-40x60	1.250
EMP.MF.20-T	Profesyonel Mayalandırma Kabini - Tekerlekli (Tek Cidarlı) Proofer - With Wheel (Single Jacket)	500x720x1800			83	0.7	1 Kw- 220 V	16-40x60	1.350
EMP.MFI.20	Profesyonel Mayalandırma Kabini (İzolasyonlu) Proofer (Isolated)	630x850x1900			93	1.02	1 Kw- 220 V	16-40x60	1.550
EMP.MFI.20-T	Profesyonel Mayalandırma Kabini - Tekerlekli (İzolasyonlu) Proofer - With Wheel (Isolated)	630x850x1900			96	1.02	1 Kw- 220 V	16-40x60	1.650

Türkçe

PROFESYONEL MAYALANDIRMA KABİNİ

- İzolasyonlu kabinler için;
40 kg/m³ yoğunluk.
- 0°C - 90°C çalışma ısısı.
- 20-40x60 tepsi kapasitesi.
- Termostatik sıcaklık kontrol ayarı.
- Nem Sensörü.
- Buhar Rezistansı.
- Manuel buhar verme.
- Paslanmaz çelik gövde.

English

PROOFER

- For Isolated cabinet;
40 kg/m³ density.
- 0°C - 90°C operating temperature.
- 20-40x60 tray capacity.
- Thermostatic electronic heating control setting.
- Humidity sensor.
- Steam resistance.
- Manuel resistance.
- Stainless steel body.



EMP.MF.20-T

Döner Tabanlı Elektrikli Pizza Fırını
Rotating Electric Pizza Oven



Kod Code	Ürün Adı Description	Ebatlar Dimension mm			Ağırlık Weight kg	Net Net m³	Güç Power kw	Kapasite Capacity	Fiyatı Price Euro
		a	b	c					
EMP.SPO.01	Döner Tabanlı Elektrikli Pizza Fırını Rotating Electric Pizza Oven	1400	1200	1980	330	3.32	16	Ø 300 mm 6 pizza 75 pizza / saat 75 Pizza / Hour	7.500

Kod Code	Elektrik Girişi Electric Input V	Kablo Kesiti Cable Cross Section mm²
EMP.SPO.01	380	5x4

Türkçe

DÖNER TABANLI ELEKTRİKLİ PİZZA FIRINI

- 4.3 inç renkli LCD ekran kontrol paneli.
- Harici bellek ile hafızaya menü yükleyebilme özelliği.
- 99 ayrı program özelliği.
- Ekran üzerinden program ismi tanımlama özelliği.
- Ekran üzerinden kullanım kılavuzuna ulaşabilme özelliği.
- Ayarlanabilir pişirme süresi ve dijital göstergesi.
- 0° C- 400° C arasında ayarlanabilir pişirme sıcaklığı ve dijital göstergesi.
- 450° C lik limit termostat.
- PID sistemiyle hassas ısı kontrolü. (SSR röleli)
- 16 KW / 380 V 50 Hz. Güç.
- 170 mm fırın iç yüksekliği.
- 1000 mm fırın pişirme taşı.
- 500x140 mm kapı ölçüsü.
- Homojen pişirme sağlayan döner taban.
- Refraktör pişirme taşı.
- Paslanmaz çelik iç hazne.
- Dijital iç sıcaklık göstergesi.
- Ø 300 mm 6 pizza 75 pizza / saat.

English

ROTATING ELECTRIC PIZZA OVEN

- 4.3 inch touch screen LCD control panel.
- Illustrated menu upload option through external memory.
- 99 different cooking programme.
- Programme name defining option through touch screen.
- User manual accessibility through touch screen.
- Adjustable cooking time.
- Adjustable cooking temperature between 0° C- 400° C
- Safety thermostat for overheating protection (450° C).
- PID system provide sensitive heating (SSR relay).
- 16 KW / 380 V 50 Hz. Power.
- Internal high : 170 mm
- Internal diameter : 1000 mm
- Door dimension : 500x140 mm
- Rotating bedplate provides homogeneous cooking.
- Baking bedplate made by refractory material.
- Stainless steel internal reservoir.
- Digital interior temperature indicator.
- Ø 300 mm 6 pizza 75 pizza / hour.



Krem
Cream

Kahverengi
Brown

Siyah
Black



Lütfen ürün rengini belirleyiniz.
Please specify the product colour.

Su geçirmez touch kontrol paneli
Water proof touch panel control

Döner Tabanlı & Sabit Gazlı Pizza Fırınları
Rotating & Non Rotating Gas Pizza Ovens



Kod Code	Ürün Adı Description	Ebatlar Dimension mm			Ağırlık Weight kg	Net Net m³	Güç Power kw	Kapasite Capacity	Fiyatı Price Euro
		a	b	c					
EMP.SPO.02	Döner Tabanlı Gazlı Pizza Fırını Rotating Gas Pizza Oven	2127x1965x2020			1200	8.4	48 kw 380V 50 Hz	Ø 300 mm 9 pizza 130 pizza / saat 130 Pizza / Hour	11.500



Türkçe

DÖNER TABANLI GAZLI PİZZA FIRINI

- 4.3 inç renkli LCD ekran kontrol paneli.
- Harici bellek ile hafızaya menü yükleyebilme özelliği.
- 99 ayrı program özelliği.
- Ekran üzerinden program ismi tanımlama özelliği.
- Ekran üzerinden kullanım kılavuzuna ulaşabilme özelliği.
- Ayarlanabilir pişirme süresi ve dijital göstergesi.
- 0° C- 400° C arasında ayarlanabilir pişirme sıcaklığı ve dijital göstergesi.
- 450° C lik limit termostat.
- PID sistemiyle hassas ısı kontrolü. (SSR röleli)
- 220 V. 50/60 Hz. Çalışma gücü.
- LPG ve NG ile çalışabilme özelliği.
- **Gazlı veya odunlu çalışabilme olanağı.**
- 450 mm fırın iç yüksekliği.
- 1200 mm fırın pişirme taşı.
- 500x250 mm kapı ölçüsü.
- Hızlı ve verimli pişirme olanağı sağlayan termal sabitleme olanağı.
- Termostatik ısıtma.
- Homojen pişirme sağlayan döner taban.
- Refraktör pişirme taşı.
- Taş iç hazne.
- Ø 300 mm 9 pizza kapasitesi,saatte 130 pizza.

English

ROTATING GAS PİZZA OVEN

- 4.3 inch touch screen LCD control panel.
- Illustrated menu upload option through external memory.
- 99 different cooking programme.
- Programme name defining option through touch screen.
- User manuel accessibility through touch screen.
- Adjustable cooking time.
- Adjustable cooking temperature between 0° C- 400° C
- Safety thermostat for overheating protection (450° C).
- PID system provide sensitive heating (SSR relay)
- 220 V. 50/60 Hz. Operating power.
- Adaptable to LPG or NG.
- **Adaptable to operate with gas or wood.**
- Internal high : 450 mm
- Internal diameter : 1200 mm
- Door dimension : 500x250 mm
- Fast and best cooking process through thermal stability.
- Thermostatic heating.
- Rotating bedplate provides homogeneous cooking.
- Baking bedplate made by refractory material.
- Stone interior reservoir.
- Pizza capacity : 9 pieces of Ø 300 mm,130 pizza / hour.



Su geçirmez touch kontrol paneli
Water proof touch panel control

Kod Code	Ürün Adı Description	Ebatlar Dimension mm			Ağırlık Weight kg	Net Net m³	Güç Power kw	Kapasite Capacity	Fiyatı Price Euro
		a	b	c					
EMP.SPO.03	Sabit Tabanlı Gazlı Pizza Fırını Non Rotating Gas Pizza Oven	1400x1400x2020			700	3.96	48 kw 220V 50 Hz	Ø 300 mm 9 pizza 130 pizza / saat 130 Pizza / Hour	7.000

Türkçe

SABİT TABANLI GAZLI PİZZA FIRINI

- 0° C- 400° C arasında ayarlanabilir pişirme sıcaklığı ve dijital göstergesi.
- 450° C lik limit termostat.
- 220 V. 50/60 Hz. Çalışma gücü.
- LPG ve NG ile çalışabilme özelliği.
- 450 mm fırın iç yüksekliği.
- 1200 mm fırın pişirme taşı.
- Termostatik ısıtma.
- Refraktör pişirme taşı.
- Taş iç hazne.
- Ø 300 mm 9 pizza kapasitesi,saatte 130 pizza.

English

NON ROTATING GAS PİZZA OVEN

- Adjustable cooking temperature between 0° C- 400° C
- Safety thermostat for overheating protection (450° C).
- 220 V. 50/60 Hz. Operating power.
- Adaptable to LPG or NG.
- Internal high : 450 mm
- Internal diameter : 1200 mm
- Thermostatic heating.
- Baking bedplate made by refractory material.
- Stone interior reservoir.
- Pizza capacity : 9 pieces of Ø 300 mm,130 pizza / hour.



Krem Kahverengi Siyah
Cream Brown Black

Lütfen ürün rengini belirleyiniz.
Please specify the product colour.

Pizza Fırınları-Tek Katlı (Dijital Isı Göstergeli)

Single Layer Pizza Ovens (Digital Temperature Indicator)



Kod Code	Ürün Adı Description	Ebatlar Dimension mm			İç Ebatlar Interior Dimensions mm	Ağırlık Weight kg	Net Net m ³	Güç Power kw	Kapasite Capacity	Fiyatı Price Euro
		a	b	c						
EMP.4	Pizza Fırını Pizza Oven	825x710x390			525x525x145	56	0,23	3,6	Ø 250 mmx4 Pizza	700
EMP.5	Pizza Fırını Pizza Oven	890x810x435			620x620x174	67	0.31	4,5	Ø 250 mmx5 Pizza	800
EMP.6	Pizza Fırını Pizza Oven	1190x810x435			920x620x174	102	0.41	6	Ø 250 mmx6 Pizza	1.050
EMP.9	Pizza Fırını Pizza Oven	1190x1100x435			920x920x174	120	0.78	10	Ø 250 mmx9 Pizza	1.400
EMP.AS.4	Alt Stand Bottom Stand	825x610x850				18	0.43			225
EMP.AS.5	Alt Stand Bottom Stand	890x730x850				21	0.55			250
EMP.AS.6	Alt Stand Bottom Stand	1190x730x850				26	0.74			300
EMP.AS.9	Alt Stand Bottom Stand	1250x1120x850				32	1.17			400

Türkçe

4'LÜ PİZZA FIRINLARI

- 3.6 Kw / 3 Ph. 380 V güç.
- Dijital iç sıcaklık göstergesi.
- Ayarlanabilir üst ve alt ısı verimleri.
- Refraktör pişirme taşı.
- Ø 250 mm 4 pizza kapasitesi.

5'Lİ PİZZA FIRINLARI

- 4.5 Kw / 3 Ph. 380 V güç.
- Dijital iç sıcaklık göstergesi.
- Ayarlanabilir üst ve alt ısı verimleri.
- Refraktör pişirme taşı.
- Ø 250 mm 5 pizza kapasitesi.

6'LI PİZZA FIRINLARI

- 6 Kw / 3 Ph. 380 V güç.
- Dijital iç sıcaklık göstergesi.
- Ayarlanabilir üst ve alt ısı verimleri.
- Refraktör pişirme taşı.
- Ø 250 mm 6 pizza kapasitesi.

9'LU PİZZA FIRINLARI

- 10 Kw / 3 Ph. 380 V güç.
- Dijital iç sıcaklık göstergesi.
- Ayarlanabilir üst ve alt ısı verimleri.
- Refraktör pişirme taşı.
- Ø 250 mm 9 pizza kapasitesi.

English

PIZZA OVENS-4

- 3.6 Kw / 3 Ph. 380 V power.
- Digital interior temperature indicator.
- Adjustable top and bottom heating output.
- Baking bedplate made by refractory material.
- Pizza capacity: 4 pieces of Ø 250 mm

PIZZA OVENS-5

- 4.5 Kw / 3 Ph. 380 V power.
- Digital interior temperature indicator.
- Adjustable top and bottom heating output.
- Baking bedplate made by refractory material.
- Pizza capacity: 5 pieces of Ø 250 mm

PIZZA OVENS-6

- 6 Kw / 3 Ph. 380 V power.
- Digital interior temperature indicator.
- Adjustable top and bottom heating output.
- Baking bedplate made by refractory material.
- Pizza capacity: 6 pieces of Ø 250 mm

PIZZA OVENS-9

- 10 Kw / 3 Ph. 380 V power.
- Digital interior temperature indicator.
- Adjustable top and bottom heating output.
- Baking bedplate made by refractory material.
- Pizza capacity: 9 pieces of Ø 250 mm

Kod Code	Elektrik Girişi Electric Input V	Kablo Kesiti Cable Cross Section mm ²
EMP.4	380	5x2.5
EMP.5	380	5x2.5
EMP.6	380	5x2.5
EMP.9	380	5x4



Pizza Fırırları-Çift Katlı (Dijital Isı Göstergeli)
Two Layers Pizza Ovens (Digital Temperature Indicator)

Kod Code	Ürün Adı Description	Ebatlar Dimension mm			İç Ebatlar Interior Dimensions mm	Ağırlık Weight kg	Net Net m³	Güç Power kw	Kapasite Capacity	Fiyatı Price Euro
		a	b	c						
EMP.4+4	Pizza Fırını Pizza Oven	825	710	670	525x525x145	95	0.40	7.2	Ø 250 mmx4+4 Pizza	1.150
EMP.5+5	Pizza Fırını Pizza Oven	890	810	760	620x620x174	115	0.53	9	Ø 250 mmx5+5 Pizza	1.350
EMP.6+6	Pizza Fırını Pizza Oven	1190	810	760	920x620x174	170	0.70	12	Ø 250 mmx6+6 Pizza	1.900
EMP.9+9	Pizza Fırını Pizza Oven	1190	1110	760	920x920x174	220	1.25	18	Ø 250 mmx9+9 Pizza	2.350
EMP.AS.4	Alt Stand Bottom Stand	825	610	850		18	0.43			225
EMP.AS.5	Alt Stand Bottom Stand	890	730	850		21	0.55			250
EMP.AS.6	Alt Stand Bottom Stand	1190	730	850		26	0.74			300
EMP.AS.9	Alt Stand Bottom Stand	1250	1120	850		32	1.19			400

Kod Code	Elektrik Girişi Electric Input V	Kablo Kesiti Cable Cross Section mm²
EMP.4+4	380	5x2.5
EMP.5+5	380	5x2.5
EMP.6+6	380	5x2.5
EMP.9+9	380	5x6

Türkçe

4+4 PİZZA FIRINLARI

- 7.2 Kw / 3 Ph. 380 V güç.
- Dijital iç sıcaklık göstergesi.
- Her bir fırın için, ayarlanabilir üst ve alt ısı dereceleri.
- Refraktör pişirme taşı.
- Ø 250 mm 8 pizza kapasitesi.

5+5 PİZZA FIRINLARI

- 9 Kw / 3 Ph. 380 V güç.
- Dijital iç sıcaklık göstergesi.
- Her bir fırın için, ayarlanabilir üst ve alt ısı dereceleri.
- Refraktör pişirme taşı.
- Ø 250 mm 10 pizza kapasitesi.

6+6 PİZZA FIRINLARI

- 12 KW / 3 Ph. 380 V güç.
- Dijital iç sıcaklık göstergesi.
- Her bir fırın için, ayarlanabilir üst ve alt ısı dereceleri.
- Refraktör pişirme taşı.
- Ø 250 mm 12 pizza kapasitesi.

9+9 PİZZA FIRINLARI

- 18 KW / 3 Ph. 380 V güç.
- Dijital iç sıcaklık göstergesi.
- Her bir fırın için, ayarlanabilir üst ve alt ısı dereceleri.
- Refraktör pişirme taşı.
- Ø 250 mm 18 pizza kapasitesi.

English

PIZZA OVENS-4+4

- 7.2 KW / 3 Ph. 380 V power.
- Digital interior temperature indicator.
- Adjustable top and bottom heating degree for each oven.
- Baking bedplate made by refractory material.
- Pizza capacity: 8 pieces of Ø 250 mm

PIZZA OVENS-5+5

- 9 KW / 3 Ph. 380 V power.
- Digital interior temperature indicator.
- Adjustable top and bottom heating degree for each oven.
- Baking bedplate made by refractory material.
- Pizza capacity: 10 pieces of Ø 250 mm

PIZZA OVENS-6+6

- 12 KW / 3 Ph. 380 V power.
- Digital interior temperature indicator.
- Adjustable top and bottom heating degree for each oven.
- Baking bedplate made by refractory material.
- Pizza capacity: 12 pieces of Ø 250 mm

PIZZA OVENS-9+9

- 18 KW / 3 Ph. 380 V power.
- Digital interior temperature indicator.
- Adjustable top and bottom heating degree for each oven.
- Baking bedplate made by refractory material.
- Pizza capacity: 18 pieces of Ø 250 mm

Gold Midi ve Maxi Pizza Fırınları (Elektrikli) Gold Midi and Maxi Pizza Ovens (Electrical)



Kod Code	Ürün Adı Description	Ebatlar Dimension mm			İç Ebatlar Interior Dimensions mm	Ağırlık Weight kg	Net Net m³	Güç Power kw	Kapasite Capacity	Fiyatı Price Euro
		a	b	c						
EMP.GF.01	Gold Midi Pizza Fırını Gold Midi Pizza Oven	1480x920x860			1025x620x240	150	1.17	14 Kw	Ø 300 mmx 6+6 Pizza	3.100
EMP.GS.01	Gold Midi Pizza Fırın Standı Gold Midi Pizza Oven Stand	1480x800x930				70	1.10			600
EMP.GF.02	Gold Maxi Pizza Fırını Gold Maxi Pizza Oven	1660x1090x860			1210x800x240	170	1.56	16 Kw	Ø 400 mmx 6+6 Pizza	4.000
EMP.GS.02	Gold Maxi Pizza Fırın Standı Gold Maxi Pizza Oven Stand	1660x890x930				90	1.37			800

Kod Code	Elektrik Girişi Electric Input V	Kablo Kesiti Cable Cross Section mm²
EMP.GF.01	380	5x4
EMP.GF.02	380	5x4

Türkçe

GOLD MİDİ PİZZA FIRINLARI

- 2x7=14 kw fırın gücü.
- Dijital iç sıcaklık göstergesi.
- 400° C maksimum sıcaklık.
- Ayarlanabilir üst ve alt ısı dereceleri.
- Eşit ısı dağılımı.
- Dijital termostat.
- Refraktör pişirme taşı.
- Ø 300 mm'lik 6+6 pizza kapasitesi.

GOLD MAXİ PİZZA FIRINLARI

- 2x8=16 kw fırın gücü.
- 400° C maksimum sıcaklık.
- Ayarlanabilir üst ve alt ısı dereceleri.
- Eşit ısı dağılımı.
- Dijital termostat.
- Refraktör pişirme taşı.
- Ø 400 mm'lik 6+6 pizza kapasitesi.

GOLD MİDİ-MAXİ ALT STAND

- Taban ve ara rafı.
- 2 adet frenli 360° dönebilen hareketli teker.
- 2 adet frensiz 360° dönebilen hareketli teker.

English

GOLD MİDİ PİZZA OVENS

- Power:2x7=14 kw
- Digital interior temperature indicator.
- Max temperature:400° C
- Adjustable top and bottom heating degree for each layer.
- Homogenous heat distribution.
- Digital thermostat.
- Baking bedplate made by refractory material.
- Pizza capacity: 6+6 pieces of Ø 300 mm

GOLD MAXİ PİZZA OVENS

- Power: 2x8=16 kw
- Max temperature:400° C
- Adjustable top and bottom heating degree for each layer
- Homogenous heat distribution
- Digital thermostat.
- Baking bedplate made by refractory material.
- Pizza capacity: 6+6 pieces of Ø 400 mm

GOLD MİDİ-MAXİ BOTTOM STAND

- Bottom and middle shelves.
- 2 castors with brake.
- 2 castors without brake.



Pizza Fırınları (Gazlı)
Pizza Ovens (Gas)



EMP.4G



EMP.4+4G

Kod Code	Ürün Adı Description	Ebatlar Dimension mm			İç Ebatlar Interior Dimensions mm	Ağırlık Weight kg	Net Net m ³	Güç Power kw	Kapasite Capacity	Fiyatı Price Euro
		a	b	c						
EMP.4G	Pizza Fırını - Gazlı Pizza Oven - Gas	1100	950	520	615x615x150	125	0,54	11.3	Ø 300 mmx4 Pizza	1.600
EMP.4+4G	Pizza Fırını - Gazlı Pizza Oven - Gas	1100	950	1040	615x615x150	250	1.08	22.6	Ø 300 mmx4+4 Pizza	3.200
EMP.6G	Pizza Fırını - Gazlı Pizza Oven - Gas	1400	950	520	915x615x150	161	0.69	17	Ø 300 mmx6 Pizza	1.900
EMP.6+6G	Pizza Fırını - Gazlı Pizza Oven - Gas	1400	950	1040	915x615x150	322	1.38	35	Ø 300 mmx6+6 Pizza	3.800
EMP.9G	Pizza Fırını - Gazlı Pizza Oven - Gas	1400	1250	520	915x915x150	200	0.91	25.5	Ø 300 mmx9 Pizza	2.300
EMP.9+9G	Pizza Fırını - Gazlı Pizza Oven - Gas	1400	1250	1040	915x915x150	400	1.82	51	Ø 300 mmx9+9 Pizza	4.600
EMP.4G-S	Alt Stand Bottom Stand	910	865	850		22	0.67			300
EMP.6G-S	Alt Stand Bottom Stand	1210	865	850		36	0.89			350
EMP.9G-S	Alt Stand Bottom Stand	1210	1165	850		34	1.2			400

Kod Code	Gaz Tüketim Değeri Gas Consumption Ng	Gaz Tüketim Değeri Gas Consumption Lpg
EMP.4G	1,2 m ³ /h	0,9 kg/h
EMP.6G	1,8 m ³ /h	1,3 kg/h
EMP.9G	2,7 m ³ /h	1,9 kg/h
EMP.4+4G	2,4 m ³ /h	1,8 kg/h
EMP.6+6G	3,6 m ³ /h	2,6 kg/h
EMP.9+9G	5,4 m ³ /h	3,8 kg/h

Türkçe

4'LÜ PIZZA FIRINLARI

- LPG ve Ng ile çalışabilme özelliği.
- Magnet emniyet ventilli musluklar.
- Dijital iç sıcaklık göstergesi.
- İç sıcaklık göstergesi ile dijital termostat kontrolü.
- 2 veya daha fazla kat yapmaya imkan sağlayan modüler sistem.
- Elektronik ateşleme sistemi.
- Sürekli alev denetimi.
- Refraktör pişirme taşı.
- Ø 300 mm'lik 4 pizza kapasitesi.

6'LI PIZZA FIRINLARI

- LPG ve Ng ile çalışabilme özelliği.
- Magnet emniyet ventilli musluklar.
- Dijital iç sıcaklık göstergesi.
- İç sıcaklık göstergesi ile dijital termostat kontrolü.
- 2 veya daha fazla kat yapmaya imkan sağlayan modüler sistem.
- Elektronik ateşleme sistemi.
- Sürekli alev denetimi.
- Refraktör pişirme taşı.
- Ø 300 mm'lik 6 pizza kapasitesi.

9'LU PIZZA FIRINLARI

- LPG ve Ng ile çalışabilme özelliği.
- Magnet emniyet ventilli musluklar.
- Dijital iç sıcaklık göstergesi.
- İç sıcaklık göstergesi ile dijital termostat kontrolü.
- 2 veya daha fazla kat yapmaya imkan sağlayan modüler sistem.
- Elektronik ateşleme sistemi.
- Sürekli alev denetimi.
- Refraktör pişirme taşı.
- Ø 300 mm'lik 9 pizza kapasitesi.

English

PIZZA OVENS-4

- Adaptable to LPG or Ng.
- Magnet safety valves.
- Digital interior temperature indicator.
- Modular deck system, pizza oven can be available with 2 or more decks.
- Electronic burner ignition.
- Constant flame control.
- Baking bedplate made by refractory material.
- Pizza capacity: 4 pieces of Ø 300 mm

PIZZA OVENS-6

- Adaptable to LPG or Ng.
- Magnet safety valves.
- Digital interior temperature indicator.
- Digital thermostat control by the interior temperature indicator.
- Modular deck system, pizza oven can be available with 2 or more decks.
- Electronic burner ignition.
- Constant flame control.
- Baking bedplate made by refractory material.
- Pizza capacity: 6 pieces of Ø 300 mm

PIZZA OVENS-9

- Adaptable to LPG or Ng.
- Magnet safety valves.
- Digital interior temperature indicator.
- Digital thermostat control by the interior temperature indicator.
- Modular deck system, pizza oven can be available with 2 or more decks.
- Electronic burner ignition.
- Constant flame control.
- Baking bedplate made by refractory material.
- Pizza capacity: 9 pieces of Ø 300 mm



Fırınlar (Pide ve Lahmacun) Ovens (Classic)

Pide Lahmacun Fırınları (Ventilsiz) / Pita and Turkish Pizza Ovens (Without Valve)

Pide Lahmacun Fırınları (Ventilli) / Pita and Turkish Pizza Ovens (With Valve)

Pasta B rek Fırınları (Gazlı) / Pastry Ovens (Gas)

B rek Pişirme Ocağı / Pastry Cooker

Pide Lahmacun Fırınları (Ventilsiz)
Pitta and Turkish Pizza Ovens (Without Valve)

Kod Code	Ürün Adı Description	Ebatlar Dimension mm			İç Ebatlar Interior Dimensions mm	Net Net m³	Güç Power kw	Fiyatı Price Euro
		a	b	c				
PLF.L1	Pide Lahmacun Fırını Ventilsiz Pitta and Turkish Pizza Without Valve	1200	1200	1720/2020	1000x1000	2.5	40	2.600
PLF.L2	Pide Lahmacun Fırını Ventilsiz Pitta and Turkish Pizza Without Valve	1200	1400	1720/2020	1000x1200	2.9	46	2.900
PLF.L4	Pide Lahmacun Fırını Ventilsiz Pitta and Turkish Pizza Without Valve	1400	1600	1720/2020	1200x1400	3.9	55	3.550
PLF.L5	Pide Lahmacun Fırını Ventilsiz Pitta and Turkish Pizza Without Valve	1600	1800	1720/2020	1400x1600	4.9	63	4.000
FÖT.00	Fırın Önü Tezgah Marble top Counter	1400	1000	1000		1.4		650

Kod Code	Gaz Tüketim Değeri Gas Consumption Lpg
PLF.L1	3,1 kg/h
PLF.L2	3,5 kg/h
PLF.L4	4,2 kg/h
PLF.L5	4,8 kg/h

Türkçe

PİDE VE LAHMACUN
FIRINLARI (VENTİLSİZ)

- 180° C -200° C sıcaklığında çalışabilir.
- İç kısımda 300 mm x 300 mm x 35 mm ateş tuğlası.
- Alt kısım galvanizli sactır.
- Üst kısım tamamen izolasyonludur.
- İstenilen renkte seramik dış kaplama.

English

PITTA AND TURKISH PIZZA OVENS (WITHOUT VALVE)

- Working temperature: 180° C -200° C .
- 300 mm x 300 mm x 35 mm firebrick coated into the oven.
- Galvanized sheet at the bottom of oven.
- Pearlitized rock wool isolation at the top of oven.
- Exterior area made by glazed tile and colour may change according to demand.

**Emniyet ventili olmayan fırınlar açık havada kullanılmak üzere üretilmiştir.
Kapalı alanda kullanılamaz.
Ovens without safety valve produced in intent to operate outdoor.
Do not operate indoor.**



Pide Lahmacun Fırınları (Ventilli)
Pitta and Turkish Pizza Ovens (With Valve)



Kod Code	Ürün Adı Description	Ebatlar Dimension mm			İç Ebatlar Interior Dimensions mm	Net Net m³	Güç Power kw	Fiyatı Price Euro
		a	b	c				
PLF.D1	Pide Lahmacun Fırını LPG - NG Emniyet Ventilli Pitta and Turkish Pizza LPG - NG Safety Valve	1200x1200x1720/2020			1000x1000	2.5	40	3.200
PLF.D2	Pide Lahmacun Fırını LPG - NG Emniyet Ventilli Pitta and Turkish Pizza LPG - NG Safety Valve	1200x1400x1720/2020			1000x1200	2.9	46	3.450
PLF.D4	Pide Lahmacun Fırını LPG - NG Emniyet Ventilli Pitta and Turkish Pizza LPG - NG Safety Valve	1400x1600x1720/2020			1200x1400	3.9	55	3.950
PLF.D5	Pide Lahmacun Fırını LPG - NG Emniyet Ventilli Pitta and Turkish Pizza LPG - NG Safety Valve	1600x1800x1720/2020			1400x1600	4.9	63	4.700
FÖT.00	Fırın Önü Tezgah Marble top Counter	1400x1000x1000				1.4		650

Kod Code	Gaz Tüketim Değeri Gas Consumption Ng
PLF.D1	4,2 m³/h
PLF.D2	4,8 m³/h
PLF.D4	5,7 m³/h
PLF.D5	6,6 m³/h

Türkçe

PİDE VE LAHMACUN FIRINLARI (VENTİLLİ)

- Doğalgaz ile çalışan pide ve lahmacun fırınlarında ; magnet emniyet ventilli musluklar.
- 180° C -200° C sıcaklığında çalışabilme.
- İç kısımda 300 mm x 300 mm x 35 mm ateş tuğlası.
- Alt kısım galvanizli sactır.
- Üst kısım tamamen izolasyonludur.
- İstenilen renkte seramik dış kaplama

English

PITTA AND TURKISH PIZZA OVENS (WITH VALVE)

- Magnet safety valves on Ng operated ovens.
- Working temperature: 180° C -200° C .
- 300 mm x 300 mm x 35 mm firebrick coated into the oven.
- Galvanised sheet at the bottom of oven.
- Pearlitized rock wool isolation at the top of oven.
- Exterior area made by glazed tile and colour may change according to demand.

Pasta Börek Fırınları (Gazlı)
Pastry Ovens (Gas)



Kod Code	Ürün Adı Description	Ebatlar Dimension mm			Net Net m³	Güç Power kw	Kapasite Capacity Izgara Raf / Rack Shelf	Fiyatı Price Euro
		a	b	c				
PBF.L1	Pasta Börek Fırını LPG - Gazlı Pastry Oven LPG - Gas	970x920x1700			1.5	19	5 Sıra	1.100
PBF.D1	Pasta Börek Fırını NG (Emniyet Ventilli) Pastry Oven NG (With Safety Valve) CE	970x920x1700			1.5	19	5 Sıra	1.300

Kod Code	Gaz Tüketim Değeri Gas Consumption Ng	Gaz Tüketim Değeri Gas Consumption Lpg
PBF.L1		1,5 kg/h
PBF.D1	2 m³/h	

**Emniyet ventili olmayan fırınlar açık havada kullanılmak üzere üretilmiştir.
Kapalı alanda kullanılamaz.
Ovens without safety valve produced in intent to operate outdoor.
Do not operate indoor.**

Türkçe

PASTA BÖREK FIRINLARI

- LPG ve Ng ile çalışabilme özelliği.
- Doğalgaz ile çalışan pasta börek fırınlarında ; magnet emniyet ventilli musluklar.
- Paslanmaz çelik gövde.

English

PASTRY OVENS

- Adaptable to LPG or Ng.
- Magnet safety valves provide security on Ng operated ovens.
- Stainless steel body.

Börek Pişirme Ocağı
Pastry Cooker



BP.01



BP.03



Kod Code	Ürün Adı Description	Ebatlar Dimension mm			Net Net m ³	Güç Power kw	Fiyatı Price Euro
		a	b	c			
BP.01	Börek Pişirme Ocağı - Taban Rafılı Pastry Cooker - Bottom Shelf	700x700x850			0.4	9.5	1.270
BP.02	Börek Pişirme Ocağı - Paslanmaz Çelik Kaplı Pastry Cooker - Stainless Steel Covered	700x700x850			0.4	9.5	1.700
BP.03	Börek Pişirme Ocağı - Ahşap Kaplı Pastry Cooker - Wooden Decorated	700x700x850			0.4	9.5	1.850

Türkçe

BÖREK PİŞİRME OCAĞI

- LPG ve NG ile çalışabilme özelliği.
- Magnet emniyet ventilli musluklar.
- Dönen üst pişirici.
- 60 cm çapında tepsi haznesi.
- Paslanmaz çelik gövde.

English

PASTRY COOKER

- Adaptable to LPG or Ng
- Magnet safety valves provide security on Ng operated ovens.
- Rotating top.
- Tray reservoir capacity: 60 cm.
- Stainless steel body.



Soğutma
Cooling



G|R|O|U|P

empero@empero.com.tr



Tezgah Tipi Buzdolapları (Fanlı) / Refrigerated Counters (Fan Cooling)

Tezgah Tipi Buzdolapları (Statik Soğutma) / Refrigerated Counters (Static Cooling)

Tezgah Tipi Derin Dondurucu (Statik Soğutma) / Freezer Counters (Static Cooling)

Camlı Tezgah Tipi Buzdolapları / Glass Door Refrigerated Counters

Çekmeceli Tezgah Tipi Buzdolapları(Fanlı) / Refrigerated Counters with Drawer (Fan Cooling)

Evyeli Tezgah Tipi Buzdolapları / Refrigerated Counters With Sink

Set Altı Buzdolapları / Refrigerated Under Counters

Pizza ve Salata Hazırlık Buzdolapları / Refrigerated Pizza and Salad Preparation Counters

Pizza ve Salata Hazırlık Buzdolapları / Refrigerated Pizza and Salad Preparation Counters

Pizza ve Salata Hazırlık Buzdolapları / Refrigerated Pizza and Salad Preparation Counters

Pizza Hazırlık Buzdolabı / Refrigerated Pizza Counter

Set Üstü Saladbarlar / Refrigerated Countertop Saladbars

Granit Tablalı Hamur Hazırlık Dolapları / Granite Top Refrigerated Counter

Granit Tablalı Hamur Hazırlık Dolapları / Refrigerated Pizza Preparation Counter with Granite Top

Dik Tip Buzdolapları (Fanlı) / Refrigerated Cabinets (Fan Cooling)

Dik Tip Buzdolapları (Fanlı) / Refrigerated Cabinets (Fan Cooling)

Dik Tip Buzdolapları (Statik Soğutma) / Refrigerated Cabinets (Static Cooling)

Dik Tip Derin Dondurucu (Statik Soğutma) / Freezer Cabinets (Static Cooling)

Otomatik Programlı Fermantasyon Dolabı (Soğuk - Sıcak) / Automatic Programmed Retarder Proover

Dik Tip Buzdolapları (Pastane) / Refrigerated Cabinets (Patisserie)

Soğuk Oda Depoları (0° C /+2° C) / Cold Room (0° C / +2° C)

Soğuk Oda Depoları (-18° C) / Cold Room (-18° C)

Soğuk Oda Depoları / Cold Room

Tezgah Tipi Buzdolapları (Fanlı) Refrigerated Counters (Fan Cooling)



Kod Code	Ürün Adı Description	Ebatlar Dimension mm			Ağırlık Weight kg	Net Net m³	Güç Power kw	Kapasite Capacity lt	Fiyatı Price Euro
		a	b	c					
EMP.150.60.01	Tezgah Tipi Buzdolabı (İki Kapılı) Refrigerated Counter (Double Doors)	1500x600x850			85	0.8	0.35	250	1.375
EMP.150.70.01	Tezgah Tipi Buzdolabı (İki Kapılı) Refrigerated Counter (Double Doors)	1500x700x850			95	0.9	0.35	300	1.450
EMP.200.60.01	Tezgah Tipi Buzdolabı (Üç Kapılı) Refrigerated Counter (Triple Doors)	2000x600x850			110	1	0.35	400	1.600
EMP.200.70.01	Tezgah Tipi Buzdolabı (Üç Kapılı) Refrigerated Counter (Triple Doors)	2000x700x850			120	1.2	0.35	500	1.700
EMP.255.60.01	Tezgah Tipi Buzdolabı (Dört Kapılı) Refrigerated Counter (Four Doors)	2550x600x850			135	1.3	0.50	550	2.050
EMP.255.70.01	Tezgah Tipi Buzdolabı (Dört Kapılı) Refrigerated Counter (Four Doors)	2550x700x850			145	1.5	0.50	700	2.150

Türkçe

TEZGAH TİPİ BUZDOLAPLARI (FANLI)

- Çalışma aralığı; +0° C, + 5° C (tropikal 43° C)
- 220 V-230 V -1 +N -50 60 Hz elektrik gücü.
- "CFC Free", R-134 A soğutucu gaz.
- 40 kg/m3 yoğunluk.
- Elektronik, sıcaklık ve defrost kontrollü gösterge.
- Defrost esnasında otomatik su buharlaştırma.
- Sökülebilir havalandırma kompresör.
- Fanlı soğutma.
- 48 mm kalınlığında "ozon dostu" poliüretan izolasyon.
- 45 derecede sabit kendiliğinden kapanan kapılar.
- Yuvarlanmış üst tabla önü.
- Alüminyum panelli, bakır borulu evaporatör.
- Ayarlanabilir, paslanmaz çelik raf yuvaları, plastik kaplama iç raf.
- Paslanmaz çelik gövde.

English

REFRIGERATED COUNTERS (FAN COOLING)

- Working temperature; 0° C, + 5° C (at ambient temp. 43° C)
- 220 V-230 V -1 +N -50 60 Hz electrical power.
- "CFC Free", R-134 A refrigerant gas.
- 40 kg/m3 density.
- Electronic temperature and defrosting control and display.
- Automatic evaporation of water during defrosting.
- Removable, conditioning compressor.
- Cooling with fan.
- "Ozone-friendly" 48 mm thickness polyurethane isolation.
- Self closing doors .
- Rounded front top edges.
- Copper tube evaporator with aluminum fins.
- Adjustable, stainless steel shelf housing, plastic coated shelves.
- Stainless steel body.



Tezgah Tipi Buzdolapları (Statik Soğutma) Refrigerated Counters (Static Cooling)



Kod Code	Ürün Adı Description	Ebatlar Dimension mm			Ağırlık Weight kg	Net Net m ³	Güç Power kw	Kapasite Capacity lt	Fiyatı Price Euro
		a	b	c					
EMP.150.60.01-STA	Tezgah Tipi Buzdolabı (İki Kapılı) Refrigerated Counter (Double Doors)	1500x600x850			95	0.8	0.35	250	1.450
EMP.150.70.01-STA	Tezgah Tipi Buzdolabı (İki Kapılı) Refrigerated Counter (Double Doors)	1500x700x850			105	0.9	0.35	300	1.550
EMP.200.60.01-STA	Tezgah Tipi Buzdolabı (Üç Kapılı) Refrigerated Counter (Triple Doors)	2000x600x850			120	1	0.35	400	1.700
EMP.200.70.01-STA	Tezgah Tipi Buzdolabı (Üç Kapılı) Refrigerated Counter (Triple Doors)	2000x700x850			130	1.2	0.35	500	1.825
EMP.255.60.01-STA	Tezgah Tipi Buzdolabı (Dört Kapılı) Refrigerated Counter (Four Doors)	2550x600x850			145	1.3	0.50	550	2.200
EMP.255.70.01-STA	Tezgah Tipi Buzdolabı (Dört Kapılı) Refrigerated Counter (Four Doors)	2550x700x850			155	1.5	0.50	700	2.300

Türkçe

TEZGAH TİPİ BUZDOLAPLARI (STATİK SOĞUTMA)

- Çalışma aralığı; +0 °C , + 5 °C (tropikal 43 °C)
- 220 V-230 V -1 +N -50 60 Hz elektrik gücü.
- "CFC Free", R-134A soğutucu gaz.
- 40 kg/m³ yoğunluk.
- Elektronik, sıcaklık ve defrost kontrollü gösterge.
- Defrost esnasında otomatik su buharlaştırma.
- Sökülebilir havalandırma kompresör.
- Statik soğutma.
- 48 mm kalınlığında "ozon dostu" poliüretan izolasyon.
- 45 derecede sabit kendiliğinden kapanan kapılar.
- Yuvarlanmış üst tabla önü.
- Alüminyum panelli, bakır borulu evaporatör.
- Ayarlanabilir , paslanmaz çelik raf yuvaları, plastik kaplama iç raf.
- Paslanmaz çelik gövde.

English

REFRIGERATED COUNTERS (STATIC COOLING)

- Working temperature; 0° C , + 5° C (at ambient temp.43° C)
- 220 V-230 V -1 +N -50 60 Hz electrical power.
- "CFC Free", R-134A refrigerant gas.
- 40 kg/m³ density.
- Electronic temperature and defrosting control and display.
- Automatic evaporation of water during defrosting.
- Removable, conditioning compressor.
- Static cooling.
- "Ozone-friendly" 48 mm thickness polyurethane isolation.
- Self closing doors.
- Rounded front top edges.
- Copper tube evaporator with aluminum fins.
- Adjustable, stainless steel shelf housing, plastic coated shelves.
- Stainless steel body.



Tezgah Tipi Derin Dondurucu
(Statik Soğutma)
Freezer Counters (Static Cooling)



Kod Code	Ürün Adı Description	Ebatlar Dimension mm			Ağırlık Weight kg	Net Net m³	Güç Power kw	Kapasite Capacity lt	Fiyatı Price Euro
		a	b	c					
EMP.150.60.02-STA	Tezgah Tipi Derin Dondurucu (İki Kapılı) Freezer Counters (Double Doors)	1500x600x850			95	0.8	1	250	2.050
EMP.150.70.02-STA	Tezgah Tipi Derin Dondurucu (İki Kapılı) Freezer Counters (Double Doors)	1500x700x850			105	0.9	1	300	2.150
EMP.200.60.02-STA	Tezgah Tipi Derin Dondurucu (Üç Kapılı) Freezer Counters (Triple Doors)	2000x600x850			120	1	1	400	2.375
EMP.200.70.02-STA	Tezgah Tipi Derin Dondurucu (Üç Kapılı) Freezer Counters (Triple Doors)	2000x700x850			130	1.2	1	500	2.500
EMP.255.60.02-STA	Tezgah Tipi Derin Dondurucu (Dört Kapılı) Freezer Counters (Four Doors)	2550x600x850			145	1.3	1	550	2.775
EMP.255.70.02-STA	Tezgah Tipi Derin Dondurucu (Dört Kapılı) Freezer Counters (Four Doors)	2550x700x850			155	1.5	1	700	3.050

Türkçe

TEZGAH TİPİ DERİN DONDURUCU
(STATİK SOĞUTMA)

- Derin dondurucu için çalışma aralığı; -18 ° C , -20 ° C .
- 220 V-230 V -1 +N -50 60 Hz elektrik gücü.
- "CFC Free", 404A soğutucu gaz.
- 40 kg/m3 yoğunluk.
- Elektronik, sıcaklık ve defrost kontrollü gösterge.
- Defrost esnasında otomatik su buharlaştırma.
- Sökülebilir havalandırılmalı kompresör.
- Statik soğutma.
- 48 mm kalınlığında "ozon dostu" poliüretan izolasyon.
- 45 derecede sabit kendiliğinden kapanan kapılar.
- Yuvarlanmış üst tabla önü.
- Alüminyum panelli, bakır borulu evaporatör.
- Ayarlanabilir , paslanmaz çelik raf yuvaları, plastik kaplama iç raf.
- Paslanmaz çelik gövde.

English

FREEZER COUNTERS (STATIC COOLING)

- Working temperature for freezers; -18° C, -20° C
- 220 V-230 V -1 +N -50 60 Hz electrical power.
- "CFC Free", 404A refrigerant gas.
- 40 kg/m3 density.
- Electronic temperature and defrosting control and display.
- Automatic evaporation of water during defrosting.
- Removable, conditioning compressor.
- Static cooling.
- "Ozone-friendly" 48 mm thickness polyurethane isolation.
- Self closing doors.
- Rounded front top edges.
- Copper tube evaporator with aluminum fins.
- Adjustable, stainless steel shelf housing, plastic coated shelves.
- Stainless steel body.



Camlı Tezgah Tipi Buzdolapları Glass Door Refrigerated Counters



Kod Code	Ürün Adı Description	Ebatlar Dimension mm			Ağırlık Weight kg	Net Net m ³	Güç Power kw	Kapasite Capacity lt	Fiyatı Price Euro
		a	b	c					
EMP.150.60.03	Camlı Tezgah Tipi Buzdolabı (İki Kapılı) Glass Door Refrigerated Counter (Double Doors)	1500x600x850			90	0.8	0.35	250	1.500
EMP.150.70.03	Camlı Tezgah Tipi Buzdolabı (İki Kapılı) Glass Door Refrigerated Counter (Double Doors)	1500x700x850			95	0.9	0.35	300	1.585
EMP.200.60.03	Camlı Tezgah Tipi Buzdolabı (Üç Kapılı) Glass Door Refrigerated Counter (Triple Doors)	2000x600x850			115	1	0.35	400	1.800
EMP.200.70.03	Camlı Tezgah Tipi Buzdolabı (Üç Kapılı) Glass Door Refrigerated Counter (Triple Doors)	2000x700x850			125	1.2	0.35	500	1.900
EMP.255.60.03	Camlı Tezgah Tipi Buzdolabı (Dört Kapılı) Glass Door Refrigerated Counter (Four Doors)	2550x600x850			145	1.3	0.50	550	2.300
EMP.255.70.03	Camlı Tezgah Tipi Buzdolabı (Dört Kapılı) Glass Door Refrigerated Counter (Four Doors)	2550x700x850			155	1.5	0.50	700	2.400

Türkçe

CAMLIL TEZGAH TİPİ BUZDOLAPLARI

- Çalışma aralığı; 0° C , + 5° C (tropikal 43° C)
- 220 V-230 V -1 +N -50 60 Hz elektrik gücü.
- "CFC Free" , R-134 A soğutucu gaz.
- 40 kg/m³ yoğunluk.
- Elektronik, sıcaklık ve defrost kontrollü gösterge.
- Defrost esnasında otomatik su buharlaştırma.
- Sökülebilir havalandırmalı kompresör.
- Fanlı soğutma.
- 48 mm kalınlığında "ozon dostu" poliüretan izolasyon.
- 45 derecede sabit kendiliğinden kapanan kapılar.
- Yuvarlanmış üst tabla önü.
- Alüminyum panelli,bakır borulu evaporatör.
- Ayarlanabilir , paslanmaz çelik raf yuvaları,plastik kaplama iç raf.
- Paslanmaz çelik gövde.

English

GLASS DOOR REFRIGERATED COUNTERS

- Working temperature; 0° C , + 5° C (at ambient temp.43° C)
- 220 V-230 V -1 +N -50 60 Hz electrical power.
- "CFC Free" , R-134 A refrigerant gas.
- 40 kg/m³ density.
- Electronic temperature and defrosting control and display.
- Automatic evaporation of water during defrosting.
- Removable,conditioning compressor.
- Fan cooling.
- "Ozone-friendly" 48 mm thickness polyurethane isolation.
- Self closing doors.
- Rounded front top edges.
- Copper tube evaporator with aluminum fins.
- Adjustable,stainless steel shelf housing, plastic coated shelves.
- Stainless steel body.

Çekmeceli Tezgah Tipi Buzdolapları(Fanlı) Refrigerated Counters with Drawer (Fan Cooling)



Kod Code	Ürün Adı Description	Ebatlar Dimension mm			Ağırlık Weight kg	Net Net m³	Güç Power kw	Kapasite Capacity lt	Fiyatı Price Euro
		a	b	c					
EMP.150.70.01-2C	Tezgah Tipi Buzdolabı 2 Çekmece+1 Kapı (Fanlı) Refrigerated Counter, 2 Drawers+1 Door (With Fan)	1500x700x850			95	0.9	0.35	300	1.825
EMP.200.70.01-2C	Tezgah Tipi Buzdolabı 2 Çekmece+2 Kapı (Fanlı) Refrigerated Counter, 2 Drawers+2 Doors (With Fan)	2000x700x850			120	1.2	0.35	500	2.075
EMP.200.70.01-4C	Tezgah Tipi Buzdolabı 4 Çekmece+1 Kapı (Fanlı) Refrigerated Counter, 4 Drawers+1 Door (With Fan)	2000x700x850			120	1.2	0.35	500	2.450
EMP.255.70.01-2C	Tezgah Tipi Buzdolabı 2 Çekmece + 3 Kapı (Fanlı) Refrigerated Counter, 2 Drawers + 3 Doors (With Fan)	2550x700x850			145	1.5	0.50	700	2.550
EMP.255.70.01-4C	Tezgah Tipi Buzdolabı 4 Çekmece + 2 Kapı (Fanlı) Refrigerated Counter, 4 Drawers + 2 Doors (With Fan)	2550x700x850			145	1.5	0.50	700	2.950
EMP.255.70.01-6C	Tezgah Tipi Buzdolabı 6 Çekmece + 1 Kapı (Fanlı) Refrigerated Counter, 6 Drawers + 1 Door (With Fan)	2550x700x850			145	1.5	0.50	700	3.250

Türkçe

ÇEKMECELİ TEZGAH TİPİ BUZDOLAPLARI (FANLI)

- GN 1/1 1500 mm kapasiteli çekmeceler.
- Çalışma aralığı; +0 °C , + 5 °C (tropikal 43° C)
- 220 V-230 V -1 +N -50 60 Hz elektrik gücü.
- "CFC Free" , R-134 A soğutucu gaz.
- 40 kg/m3 yoğunluk.
- Elektronik, sıcaklık ve defrost kontrollü gösterge.
- Defrost esnasında otomatik su buharlaştırma.
- Sökülebilir havalandırmalı kompresör.
- Fanlı soğutma.
- 48 mm kalınlığında "ozon dostu" poliüretan izolasyon.
- 45 derecede sabit kendiliğinden kapanan kapılar.
- Yuvarlanmış üst tabla önü.
- Alüminyum panelli,bakır borulu evaporatör.
- Ayarlanabilir , paslanmaz çelik raf yuvaları,plastik kaplama iç raf.
- Paslanmaz çelik gövde.

English

REFRIGERATED COUNTERS WITH DRAWER (FAN COOLING)

- Drawer capacity : GN 1/1 1500 mm.
- Working temperature; 0° C , + 5° C (at ambient temp. 43° C)
- 220 V-230 V -1 +N -50 60 Hz electrical power.
- "CFC Free" , R-134 A refrigerant gas.
- 40 kg/m3 density.
- Electronic temperature and defrosting control and display.
- Automatic evaporation of water during defrosting.
- Removable,conditioning compressor.
- Fan cooling.
- "Ozone-friendly" 48 mm thickness polyurethane isolation.
- Self closing doors .
- Rounded front top edges.
- Copper tube evaporator with aluminum fins.
- Adjustable,stainless steel shelf housing, plastic coated shelves.
- Stainless steel body.

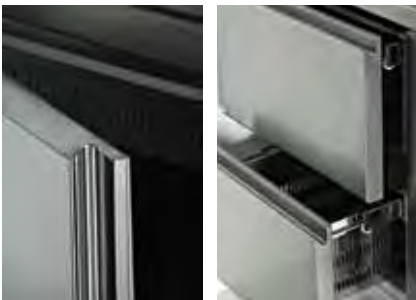

Evyeli Tezgah Tipi Buzdolapları Refrigerated Counters With Sink



Kod Code	Ürün Adı Description	Ebatlar Dimension mm			Ağırlık Weight kg	Net Net m ³	Güç Power kw	Kapasite Capacity lt	Evye Ölçüleri Sink Dimension mm	Fiyatı Price Euro
		a	b	c						
EMP.150.70.01-EV	Evyeli Tezgah Tipi Buzdolabı (İki Kapılı) Refrigerated Counter With Sink (Double Doors)	1500	700	850	95	0.9	0.35	300	350x400	1.750
EMP.200.70.01-EV	Evyeli Tezgah Tipi Buzdolabı (Üç Kapılı) Refrigerated Counter With Sink (Triple Doors)	2000	700	850	120	1.2	0.35	500	350x400	1.975
EMP.255.70.01-EV	Evyeli Tezgah Tipi Buzdolabı (Dört Kapılı) Refrigerated Counter With Sink (Four Doors)	2550	700	850	145	1.5	0.50	700	350x400	2.550

Türkçe

EVYELİ TEZGAH TİPİ BUZDOLAPLARI

- Çalışma aralığı; +0 °C , + 5 °C (tropikal 43° C)
- 220 V-230 V -1 +N -50 60 Hz elektrik gücü.
- "CFC Free" , R-134 A soğutucu gaz.
- 40 kg/m3 yoğunluk.
- Elektronik, sıcaklık ve defrost kontrollü gösterge.
- Defrost esnasında otomatik su buharlaştırma.
- Sökülebilir havalandırılmalı kompresör.
- Fanlı soğutma.
- 48 mm kalınlığında "ozon dostu" poliüretan izolasyon.
- 45 derecede sabit kendiliğinden kapanan kapılar.
- Düz üst tabla önü.
- Alüminyum panelli, bakır borulu evaporatör.
- Ayarlanabilir , paslanmaz çelik raf yuvaları, plastik kaplama iç raf.
- Paslanmaz çelik gövde.

English

REFRIGERATED COUNTERS WITH SINK

- Working temperature; 0° C , + 5° C (at ambient temp. 43° C)
- 220 V-230 V -1 +N -50 60 Hz electrical power.
- "CFC Free" , R-134 A refrigerant gas.
- 40 kg/m3 density.
- Electronic temperature and defrosting control and display.
- Automatic evaporation of water during defrosting.
- Removable, conditioning compressor.
- Fan cooling.
- "Ozone-friendly" 48 mm thickness polyurethane isolation.
- Self closing doors.
- Smooth front top edges.
- Copper tube evaporator with aluminum fins.
- Adjustable, stainless steel shelf housing, plastic coated shelves.
- Stainless steel body.



Set Altı Buzdolapları
Refrigerated Under Counters



Kod Code	Ürün Adı Description	Ebatlar Dimension mm			Ağırlık Weight kg	Net Net m ³	Güç Power kw	Kapasite Capacity Gn / Container	Fiyatı Price Euro
		a	b	c					
EMP.160.60.01-S	Set Altı Buzdolapları Refrigerated Under Counter	1600x600x550			95	0.5	0.35	2x2/3 200	1.500
EMP.200.60.01-S	Set Altı Buzdolapları Refrigerated Under Counter	2000x600x550			110	0.6	0.35	3x2/3 200	1.700
EMP.160.70.01-S	Set Altı Buzdolapları Refrigerated Under Counter	1600x700x550			90	0.6	0.35	2x1/1 200	1.600
EMP.200.70.01-S	Set Altı Buzdolapları Refrigerated Under Counter	2000x700x550			120	0.8	0.35	3x1/1 200	1.800

Türkçe

SET ALTI BUZDOLAPLARI

- Çalışma aralığı; +0 ° C , + 5° C (tropikal 43° C)
- 220 V-230 V -1 +N -50 60 Hz elektrik gücü.
- "CFC Free" , R-134 A , soğutucu gaz.
- 40 kg/m³ yoğunluk.
- Elektronik, sıcaklık ve defrost kontrollü gösterge.
- Defrost esnasında sökülebilir havalandırmalı kompresör.
- Statik soğutma.
- 48 mm kalınlığında "ozon dostu" poliüretan izolasyon.
- Düz üst tabla.
- Alüminyum panelli, bakır borulu evaporatör.
- Ayarlanabilir, paslanmaz çelik raf yuvaları, plastik kaplama iç raf.
- Paslanmaz çelik gövde.

English

REFRIGERATED UNDER COUNTERS

- Working temperature; 0° C , + 5° C (at ambient temp. 43° C)
- 220 V-230 V -1 +N -50 60 Hz electrical power.
- "CFC Free" , R-134 A gas.
- 40 kg/m³ density.
- Electronic temperature and defrosting control and display.
- Automatic evaporation of water during defrosting.
- Removable, conditioning compressor.
- "Ozone-friendly" 48 mm thickness polyurethane isolation.
- Smooth front top edges.
- Copper tube evaporator with aluminum fins.
- Adjustable, stainless steel shelf housing, plastic coated shelves.
- Stainless steel body.





Pizza ve Salata Hazırlık Buzdolapları
Refrigerated Pizza and Salad Preparation Counters



Kod Code	Ürün Adı Description	Ebatlar Dimension mm			Ağırlık Weight kg	Net Net m³	Güç Power kw	Kapasite Capacity lt	Fiyatı Price Euro
		a	b	c					
EMP.150.70.01-PS	Pizza ve Salata Hazırlık Buzdolapları (İki Kapılı) Refrigerated Pizza and Salad Preparation Counter (Double Doors)	1500	700	850/1050	110	0.9	0.35	300	1.900
EMP.200.70.01-PS	Pizza ve Salata Hazırlık Buzdolapları (Üç Kapılı) Refrigerated Pizza and Salad Preparation Counter (Triple Doors)	2000	700	850/1050	135	1.2	0.35	500	2.400

Türkçe

PIZZA VE SALATA HAZIRLIK BUZDOLAPLARI

- 1500 mm'de 1/4-100 8 adet GN.küvet kapasiteli.
- 2000 mm'de 1/4-100 10 adet GN.küvet kapasiteli.
- Çalışma aralığı; +0 ° C , + 5° C (tropikal 43° C)
- 220 V-230 V -1 +N -50 60 Hz elektrik gücü.
- "CFC Free" , R-134 A soğutucu gaz.
- 40 kg/m3 yoğunluk.
- Elektronik, sıcaklık ve defrost kontrollü gösterge.
- Defrost esnasında otomatik su buharlaştırma.
- Sökülebilir havalandırmalı kompresör.
- Fanlı soğutma.
- 48 mm kalınlığında "ozon dostu" poliüretan izolasyon.
- 45 derecede sabit kendiliğinden kapanan kapılar.
- Yuvarlanmış üst tabla önü.
- Alüminyum panelli,bakır borulu evaporatör.
- Ayarlanabilir , paslanmaz çelik raf yuvaları,plastik kaplama iç raf.
- Paslanmaz çelik gövde.

*Standart üretimimizde küvet bulunmamaktadır.

*GN küvet haznesi kapalı statik soğutmalıdır.

English

REFRIGERATED PIZZA AND SALAD PREPARATION COUNTERS

- Capacity for 2 door refrigerator : 8 pieces of 1/4-100 gastronom container.
- Capacity for 3 door refrigerator:10 pieces 1/4-100 gastronom container.
- Working temperature; 0° C , + 5° C (at ambient temp.43° C)
- 220 V-230 V -1 +N -50 60 Hz electrical power.
- "CFC Free" , R-134 A refrigerant gas.
- 40 kg/m3 density.
- Electronic temperature and defrosting control and display.
- Automatic evaporation of water during defrosting.
- Removable,conditioning compressor.
- Fan cooling.
- "Ozone-friendly" 48 mm thickness polyurethane isolation.
- Self closing doors.
- Rounded front top edges.
- Copper tube evaporator with aluminum fins.
- Adjustable,stainless steel shelf housing,plastic coated shelves.
- Stainless steel body.

*Standart product does not have containers.

*GN container tank covered by static cooling.



Pizza ve Salata Hazırlık Buzdolapları
Refrigerated Pizza and Salad Preparation Counters



Kod Code	Ürün Adı Description	Ebatlar Dimension mm			Ağırlık Weight kg	Net Net m³	Güç Power kw	Kapasite Capacity lt	Fiyatı Price Euro
		a	b	c					
EMP.150.70.01-PSO	Pizza ve Salata Hazırlık Buzdolapları (İki Kapılı) Refrigerated Pizza and Salad Preparation Counter (Double Doors)	1500	700	850	110	0.9	0.45	300	1.800
EMP.200.70.01-PSO	Pizza ve Salata Hazırlık Buzdolapları (Üç Kapılı) Refrigerated Pizza and Salad Preparation Counter (Triple Doors)	2000	700	850	135	1.2	0.45	500	2.350

Türkçe

PIZZA VE SALATA HAZIRLIK BUZDOLAPLARI

- 1500 mm'de 1/4-100 6 adet GN.küvet kapasiteli.
- 2000 mm'de 1/4-100 8 adet GN.küvet kapasiteli.
- Çalışma aralığı; +0 ° C , + 5° C (tropikal 43° C)
- 220 V-230 V -1 +N -50 60 Hz elektrik gücü.
- "CFC Free" , 404 A soğutucu gaz.
- 40 kg/m3 yoğunluk.
- Elektronik, sıcaklık ve defrost kontrollü gösterge.
- Defrost esnasında otomatik su buharlaştırma.
- Sökülebilir havalandırmalı kompresör.
- Fanlı soğutma.
- 48 mm kalınlığında "ozon dostu" poliüretan izolasyon.
- 45 derecede sabit kendiliğinden kapanan kapılar.
- Yuvarlanmış üst tabla önü.
- Alüminyum panelli,bakır borulu evaporatör.
- Ayarlanabilir , paslanmaz çelik raf yuvaları,plastik kaplama iç raf.
- Paslanmaz çelik gövde.

*Standart üretimimizde küvet bulunmamaktadır.

*GN küvet haznesi kapalı statik soğutmalıdır.

English

REFRIGERATED PIZZA AND SALAD PREPARATION COUNTERS

- Capacity for 2 door refrigerator : 6 pieces of 1/4-100 gastronom container.
- Capacity for 3 door refrigerator: 8 pieces 1/4-100 gastronom container.
- Working temperature; 0° C , + 5° C (at ambient temp.43° C)
- 220 V-230 V -1 +N -50 60 Hz electrical power.
- "CFC Free" , 404 A refrigerant gas.
- 40 kg/m3 density.
- Electronic temperature and defrosting control and display.
- Automatic evaporation of water during defrosting.
- Removable,conditioning compressor.
- Fan cooling.
- "Ozone-friendly" 48 mm thickness polyurethane isolation.
- Self closing doors.
- Rounded front top edges.
- Copper tube evaporator with aluminum fins.
- Adjustable,stainless steel shelf housing,plastic coated shelves.
- Stainless steel body.

*Standart product does not have containers.

*GN container tank covered by static cooling.

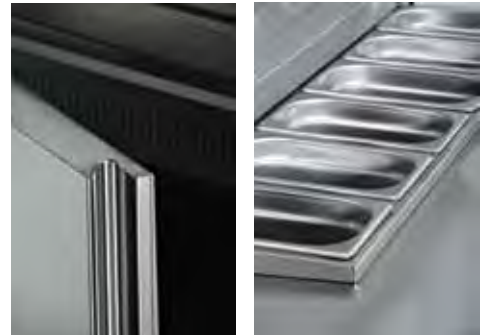

Pizza ve Salata Hazırlık Buzdolapları
Refrigerated Pizza and Salad Preparation Counters



EMP.150.80.01-PSY



EMP.150.80.01-PSYG



Kod Code	Ürün Adı Description	Ebatlar Dimension mm			Ağırlık Weight kg	Net Net m³	Güç Power kw	Kapasite Capacity lt	Fiyatı Price Euro
		a	b	c					
EMP.150.80.01-PSY	Pizza ve Salata Hazırlık Buzdolapları (İki Kapılı) Pizza and Salad Preparation Refrigerators (Double Doors)	1500x800x850/1350			115	0.9	0.35	300	2.000
EMP.200.80.01-PSY	Pizza ve Salata Hazırlık Buzdolapları (Üç Kapılı) Pizza and Salad Preparation Refrigerators (Triple Doors)	2000x800x850/1350			140	1.2	0.35	500	2.450

Kod Code	Ürün Adı Description	Ebatlar Dimension mm			Ağırlık Weight kg	Net Net m³	Güç Power kw	Kapasite Capacity lt	Fiyatı Price Euro
		a	b	c					
EMP.150.80.01-PSYG	Granitli Pizza ve Salata Hazırlık Buzdolapları (İki Kapılı) Granite Pizza and Salad Preparation Refrigerators (Double Doors)	1500x800x850/1350			115	0.9	0.35	300	2.450
EMP.200.80.01-PSYG	Granitli Pizza ve Salata Hazırlık Buzdolapları (Üç Kapılı) Granite Pizza and Salad Preparation Refrigerators (Triple Doors)	2000x800x850/1350			140	1.2	0.35	500	2.900

Türkçe

PIZZA VE SALATA HAZIRLIK BUZDOLAPLARI

- 1500 mm'de 1/4-100 8 adet GN.küvet kapasiteli.
- 2000 mm'de 1/4-100 11 adet GN.küvet kapasiteli.
- Çalışma aralığı; +0 °C , + 5° C (tropikal 43° C)
- 220 V-230 V -1 +N -50 60 Hz elektrik gücü.
- "CFC Free" , R-134 A soğutucu gaz.
- 40 kg/m3 yoğunluk.
- Elektronik, sıcaklık ve defrost kontrollü gösterge.
- Defrost esnasında otomatik su buharlaştırma.
- Sökülebilir havalandırmalı kompresör.
- Fanlı soğutma.
- 48 mm kalınlığında "ozon dostu" poliüretan izolasyon.
- 45 derecede sabit kendiliğinden kapanan kapılar.
- Yuvarlanmış üst tabla önü.
- Alüminyum panelli,bakır borulu evaporatör.
- Ayarlanabilir , paslanmaz çelik raf yuvaları,plastik kaplama iç raf.
- Paslanmaz çelik gövde.

*Standart üretimimizde küvet bulunmamaktadır.
*GN küvet haznesi kapalı statik soğutmalıdır.

English

REFRIGERATED PIZZA AND SALAD PREPARATION COUNTERS

- Capacity for 2 door refrigerator : 8 pieces of 1/4-100 gastronom container.
- Capacity for 3 door refrigerator:11 pieces 1/4-100 gastronom container.
- Working temperature; 0° C , + 5° C (at ambient temp. 43° C)
- 220 V-230 V -1 +N -50 60 Hz electrical power.
- "CFC Free" , R-134 A refrigerant gas.
- 40 kg/m3 density.
- Electronic temperature and defrosting control and display.
- Automatic evaporation of water during defrosting.
- Removable,conditioning compressor.
- Fan cooling.
- "Ozone-friendly" 48 mm thickness polyurethane isolation.
- Self closing doors .
- Rounded front top edges.
- Copper tube evaporator with aluminum fins.
- Adjustable,stainless steel shelf housing,plastic coated shelves.
- Stainless steel body.

*Standart product does not have containers.
*GN container tank covered by static cooling.

Pizza Hazırlık Buzdolabı
Refrigerated Pizza Counter



Kod Code	Ürün Adı Description	Ebatlar Dimension mm			Ağırlık Weight kg	Net Net m³	Güç Power kw	Kapasite Capacity lt	Fiyatı Price Euro
		a	b	c					
EMP.210.80.01.ORI	Pizza Hazırlık Buzdolabı (Üç Kapılı) Refrigerated Pizza Counter (Triple Doors)	2100	880	850/1350	300	2.48	0.45	500	3.400
EMP.265.80.01.ORI	Pizza Hazırlık Buzdolabı (Dört Kapılı) Refrigerated Pizza Counter (Four Doors)	2600	880	850/1350	340	3.15	0.50	700	3.900

Türkçe

PİZZA HAZIRLIK BUZDOLABI

- 2100 mm'de 1/4-100 12 adet Gn.Küvet kapasiteli
- 2600 mm'de 1/4-100 15 adet Gn.Küvet kapasiteli
- Her kapakta 4 adet 400x600 mm tepsi kapasitesi.
- Çalışma aralığı: +0 °C , + 5 °C (tropikal 43° C)
- 220 V-230 V -1 +N -50 60 Hz elektrik gücü.
- "CFC FREE" , 404 A soğutucu gaz.
- 40 kg/m³ yoğunluk.
- Elektronik, sıcaklık ve defrost kontrollü gösterge.
- Defrost esnasında otomatik su buharlaştırma.
- Sökülebilir havalandırmalı kompresör.
- Fanlı soğutma.
- 48 mm kalınlığında "ozon dostu" poliüretan izolasyon.
- 45 derecede sabit kendiliğinden kapanan kapılar.
- Alüminyum panelli, bakır borulu evaporatör.
- Ayarlanabilir, paslanmaz çelik raf yuvaları, plastik kaplama iç raf.
- Led aydınlatma.
- Opsiyonel ön ahşap giydirme.

*Standart üretimimizde küvet bulunmamaktadır.

English

REFRIGERATED PIZZA COUNTER

- Capacity for 3 door refrigerator:12 pieces of 1/4-100 gastronorm container.
- Capacity for 4 door refrigerator:15 pieces of 1/4-100 gastronorm container.
- Tray grid capacity: 4 pieces 400x600 mm for each.
- Working temperature: +0 °C , + 5 °C (at ambient temp. 43° C)
- 220 V-230 V -1 +N -50 60 Hz electrical power.
- "CFC Free" , 404 A refrigerated gas.
- 40 kg/m³ density.
- Electronic temperature and defrosting control and display.
- Automatic evaporation of water during defrosting.
- Removable, conditioning compressor.
- Fan cooling.
- "Ozone - Friendly" 48 mm thickness polyurethane isolation.
- Self closing doors.
- Copper tube evaporator with aluminum fins.
- Adjustable, stainless steel shelf housing, plastic coated shelves.
- Led lighting.
- Optional Wooden front surface.

*Standart product does not have containers.



Set Üstü Saladbarlar Refrigerated Countertop Saladbars



Kod Code	Ürün Adı Description	Ebatlar Dimension mm			Ağırlık Weight kg	Net Net m ³	Güç Power kw	Fiyatı Price Euro
		a	b	c				
EMP.160	Set Üstü Saladbar Refrigerated Countertop Saladbars	1600x350x500			45	0.3	0.2	800
EMP.210	Set Üstü Saladbar Refrigerated Countertop Saladbars	2100x350x500			55	0.4	0.2	900

Türkçe

SET ÜSTÜ SALADBARLAR

- 1600 mm'de 1/4-100 7 adet GN.küvet kapasiteli.
- 2100 mm'de 1/4-100 9 adet GN.küvet kapasiteli.
- Çalışma aralığı; +0 ° C , + 5° C (tropikal 43° C).
- 220 V-230 V -1 +N -50 60 Hz elektrik gücü.
- "CFC Free" , R-134 A soğutucu gaz.
- 40 kg/m3 yoğunluk.
- Elektronik, sıcaklık ve defrost kontrollü gösterge.
- Statik soğutma.
- "Ozon dostu" poliüretan izolasyon.
- Alüminyum panelli,bakır borulu evaporatör.
- Paslanmaz çelik gövde.

English

REFRIGERATED COUNTERTOP SALADBAR

- Capacity for 1600 mm : 7 pieces of 1/4-100 gastronom container.
- Capacity for 2100 mm : 9 pieces of 1/4-100 gastronom container.
- Working temperature; 0° C , + 5° C (at ambient temp. 43° C)
- 220 V-230 V -1 +N -50 60 Hz electrical power.
- "CFC Free" , R-134 A refrigerant gas.
- 40 kg/m3 density.
- Electronic temperature and defrosting control and display.
- Static Cooling.
- "Ozone-friendly" polyurethane isolation.
- Copper tube evaporator with aluminum fins.
- Stainless steel body.

*Standart üretimimizde küvet bulunmamaktadır.

*Standart product does not have containers.

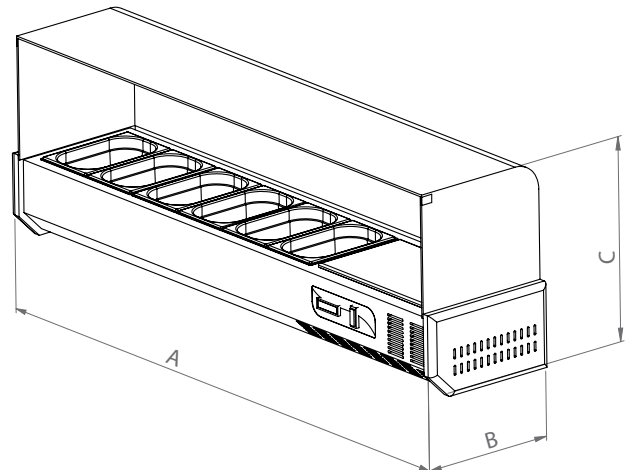

Granit Tablalı Hamur Hazırlık Dolapları Granite Top Refrigerated Counter



Kod Code	Ürün Adı Description	Ebatlar Dimension mm			Ağırlık Weight kg	Net Net m³	Güç Power kw	Kapasite Capacity lt	Fiyatı Price Euro
		a	b	c					
EMP.160.80.01	Granit Tablalı Hamur Hazırlık Dolapları (İki Kapılı) Granite Top Refrigerated Counter (Double Door)	1600x800x1020			175	1.1	0.35	300	2.300
EMP.210.80.01	Granit Tablalı Hamur Hazırlık Dolapları (Üç Kapılı) Granite Top Refrigerated Counter (Triple Door)	2100x800x1020			220	1.5	0.35	500	2.600

Türkçe

GRANİT TABLALI HAMUR HAZIRLIK DOLAPLARI

- 2 adet 400x600 mm mayalandırma çekmecesini.
- Her kapakta 4 adet 400x600 mm tepsi kapasitesi.
- Çalışma aralığı; +0 °C , + 5 °C (tropikal 43° C)
- 220 V-230 V -1 +N -50 60 Hz elektrik gücü.
- "CFC Free" , R-134 A soğutucu gaz.
- 40 kg/m³ yoğunluk.
- Elektronik, sıcaklık ve defrost kontrollü gösterge.
- Defrost esnasında otomatik su buharlaştırma.
- Sökülebilir havalandırma kompresör.
- Fanlı soğutma.
- 48 mm kalınlığında "ozon dostu" poliüretan izolasyon.
- 45 derecede sabit kendiliğinden kapanan kapılar.
- Alüminyum panelli,bakır borulu evaporatör.
- Ayarlanabilir, paslanmaz çelik raf yuvaları, plastik kaplama iç raf.
- Granit üst tabla.
- Paslanmaz çelik gövde.

English

GRANITE TOP REFRIGERATED COUNTER

- Fermentation drawer capacity: 2 pieces 400x600 mm
- Tray grid capacity: 4 pieces 400x600 mm for each.
- Working temperature; 0° C , + 5° C (at ambient temp. 43° C)
- 220 V-230 V -1 +N -50 60 Hz electrical power.
- "CFC Free" , R-134 A refrigerant gas.
- 40 kg/m3 density.
- Electronic temperature and defrosting control and display.
- Automatic evaporation of water during defrosting.
- Removable,conditioning compressor.
- Fan cooling.
- "Ozone-friendly" 48 mm thickness polyurethane isolation.
- Self closing doors .
- Copper tube evaporator with aluminum fins.
- Adjustable, stainless steel shelf housing, plastic coated shelves.
- Granite top.
- Stainless steel body.



Granit Tablalı Hamur Hazırlık Dolapları Refrigerated Pizza Preparation Counter with Granite Top



Kod Code	Ürün Adı Description	Ebatlar Dimension mm			Ağırlık Weight kg	Net Net m³	Güç Power kw	Kapasite Capacity lt	Fiyatı Price Euro
		a	b	c					
EMP.160.80.02	Granit Tablalı Hamur Hazırlık Dolapları (İki Kapılı) Refrigerated Pizza Preparation Counter with Granite Top (Double Door)	1600	800	1020/1520	220	1.8	0.55	300	3.100
EMP.210.80.02	Granit Tablalı Hamur Hazırlık Dolapları (Üç Kapılı) Refrigerated Pizza Preparation Counter with Granite Top (Triple Door)	2100	800	1020/1520	275	2.3	0.55	500	3.500

Türkçe

GRANİT TABLALI HAMUR HAZIRLIK DOLAPLARI

- 1600 mm'de 1/4-100 7 adet GN.küvet kapasiteli.
- 2100 mm'de 1/4-100 9 adet GN.küvet kapasiteli.
- Her kapakta 4 adet 400x600 mm tepsi kapasitesi.
- 2 adet 400x600 mm mayalandırma çekmecesi.
- Çalışma aralığı; +0 ° C , + 5 ° C (tropikal 43° C)
- 220 V-230 V -1 +N -50 60 Hz elektrik gücü.
- "CFC Free" , R-134 A soğutucu gaz.
- 40 kg/m³ yoğunluk.
- Elektronik, sıcaklık ve defrost kontrollü gösterge.
- Defrost esnasında otomatik su buharlaştırma.
- Sökülebilir havalandırmalı kompresör.
- Fanlı soğutuculu alt buzdolabı, statik soğutuculu setüstü saladbar.
- 48 mm kalınlığında "ozon dostu" poliüretan izolasyon.
- 45 derecede sabit kendiliğinden kapanan kapılar.
- Alüminyum panelli,bakır borulu evaporatör.
- Ayarlanabilir, paslanmaz çelik raf yuvaları, plastik kaplama iç raf.
- Granit veya mermer üst tabla seçeneği.
- Paslanmaz çelik gövde.

*Standart üretimimizde küvet bulunmamaktadır.

English

REFRIGERATED PIZZA PREPARATION COUNTER WITH GRANITE TOP

- Capacity for 2 door: 7 pieces of 1/4-100 gastronorm container.
- Capacity for 3 door: 9 pieces of 1/4-100 gastronorm container.
- Tray grid capacity: 4 pieces 400x600 mm for each.
- Fermentation drawer capacity: 2 pieces 400x600 mm.
- Working temperature; +0° C , + 5° C (at ambient temp. 43° C)
- 220 V-230 V -1 +N -50 60 Hz electrical power.
- "CFC Free" , R-134 A refrigerant gas.
- 40 kg/m3 density.
- Electronic temperature and defrosting control and display.
- Automatic evaporation of water during defrosting.
- Removable,conditioning compressor.
- Fan cooling preparation counter and countertop saladbar with static cooling.
- "Ozone-friendly" 48 mm thickness polyurethane isolation.
- Self closing doors .
- Copper tube evaporator with aluminum fins.
- Adjustable,stainless steel shelf housing,plastic coated shelves.
- Granite or marble top table options.
- Stainless steel body.

*Standart product does not have containers.



Dik Tip Buzdolapları (Fanlı)
Refrigerated Cabinets (Fan Cooling)



Kod Code	Ürün Adı Description	Ebatlar Dimension mm			Ağırlık Weight kg	Net Net m³	Güç Power kw	Kapasite Capacity lt	Fiyatı Price Euro
		a	b	c					
EMP.70.80.01	Dik Tip Buzdolabı (Tek Kapılı) Refrigerated Cabinets (Single Door)	700x800x2050			130	1.2	0.4	700	1.500
EMP.70.80.03	Cam Kapı Dik Tip Buzdolabı (Tek Kapılı) Glass Door Refrigerated Cabinets (Single Door)	700x800x2050			145	1.2	0.4	700	1.850

Türkçe

DİK TİP BUZDOLAPLARI (FANLI)

- 3 adet GN 2/1 iç raf.
- Çalışma aralığı; +0 ° C , + 5 ° C (tropikal 43° C)
- 220 V-230 V -1 +N -50 60 Hz elektrik gücü.
- "CFC Free" , R-134 A gaz.
- 40 kg/m3 yoğunluk.
- Elektronik, sıcaklık ve defrost kontrollü gösterge.
- Defrost esnasında otomatik su buharlaştırma.
- Sökülebilir havalandırmalı kompresör.
- Fanlı soğutma.
- 48 mm kalınlığında "ozon dostu" poliüretan izolasyon.
- 45 derecede sabit kendiliğinden kapanan kapılar.
- Alüminyum panelli,bakır borulu evaporatör.
- Paslanmaz çelik gövde.

English

REFRIGERATED CABINETS (FAN COOLING)

- 3 pieces GN 2/1 trays interior shelve.
- Working temperature; 0° C , + 5° C (at ambient temp. 43° C)
- 220 V-230 V -1 +N -50 60 Hz electrical power.
- "CFC Free" , R-134 A gas.
- 40 kg/m3 density.
- Electronic temperature and defrosting control and display.
- Automatic evaporation of water during defrosting.
- Removable,conditioning compressor.
- Fan cooling.
- "Ozone-friendly" 48 mm thickness polyurethane isolation.
- Self closing doors.
- Copper tube evaporator with aluminum fins.
- Stainless steel body.



EMP.70.80.03
Cam Kapı Dik Tip Buzdolabı (Tek Kapılı)
Glass Door Refrigerated Cabinets (Single Door)



Dik Tip Buzdolapları (Fanlı) Refrigerated Cabinets (Fan Cooling)

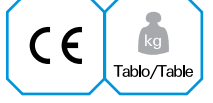

Kod Code	Ürün Adı Description	Ebatlar Dimension mm			Ağırlık Weight kg	Net Net m ³	Güç Power kw	Kapasite Capacity lt	Fiyatı Price Euro
		a	b	c					
EMP.140.80.01	Dik Tip Buzdolabı (Çift Kapılı) Refrigerated Cabinets (Double Door)	1400x800x2050			220	2.4	0.6	1400	2.000
EMP.140.80.03	Cam Kapı Dik Tip Buzdolabı (Çift Kapılı) Glass Door Refrigerated Cabinets (Double Door)	1400x800x2050			230	2.4	0.6	1400	2.650

Türkçe

DİK TİP BUZDOLAPLARI (FANLI)

- 6 adet GN 2/1 iç raf.
- Çalışma aralığı; +0 °C , + 5 °C (tropikal 43° C)
- 220 V-230 V -1 +N -50 60 Hz elektrik gücü.
- "CFC Free" , R-134 A soğutucu gaz.
- 40 kg/m3 yoğunluk.
- Elektronik, sıcaklık ve defrost kontrollü gösterge.
- Defrost esnasında otomatik su buharlaştırma.
- Sökülebilir havalandırmalı kompresör.
- Fanlı soğutma.
- 48 mm kalınlığında "ozon dostu" poliüretan izolasyon.
- 45 derecede sabit kendiliğinden kapanan kapılar.
- Alüminyum panelli,bakır borulu evaporatör.
- Paslanmaz çelik gövde.

English

REFRIGERATED CABINETS (FAN COOLING)

- 6 pieces GN 2/1 trays interior shelve.
- Working temperature; 0° C , + 5° C (at ambient temp. 43° C)
- 220 V-230 V -1 +N -50 60 Hz electrical power.
- "CFC Free" , R-134 A refrigerant gas.
- 40 kg/m3 density.
- Electronic temperature and defrosting control and display.
- Automatic evaporation of water during defrosting.
- Removable,conditioning compressor.
- Fan cooling.
- "Ozone-friendly" 48 mm thickness polyurethane isolation.
- Self closing doors.
- Copper tube evaporator with aluminum fins.
- Stainless steel body.



Dik Tip Buzdolapları (Statik Soğutma) Refrigerated Cabinets (Static Cooling)



Kod Code	Ürün Adı Description	Ebatlar Dimension mm			Ağırlık Weight kg	Net Net m³	Güç Power kw	Kapasite Capacity lt	Fiyatı Price Euro
		a	b	c					
EMP.70.80.01-STA	Dik Tip Buzdolabı (Tek Kapılı) Refrigerated Cabinets (Single Door)	700x800x2050			130	1.2	0.4	700	1.900
EMP.140.80.01-STA	Dik Tip Buzdolabı (Çift Kapılı) Refrigerated Cabinets (Double Door)	1400x800x2050			220	2.4	0.6	1400	2.850

Türkçe

DİK TİP BUZDOLAPLARI (STATİK SOĞUTMA)

- Tek kapılılar için 3 adet GN 2/1 raf.
- Çift kapılılar için 6 adet GN 2/1 raf.
- Çalışma aralığı; +0 ° C , + 5 ° C (tropikal 43° C)
- 220 V-230 V -1 +N -50 60 Hz elektrik gücü.
- "CFC Free" , R-134 A soğutucu gaz.
- 40 kg/m3 yoğunluk.
- Elektronik, sıcaklık ve defrost kontrollü gösterge.
- Defrost esnasında otomatik su buharlaştırma.
- Sökülebilir havalandırmalı kompresör.
- Statik soğutma.
- 48 mm kalınlığında "ozon dostu" poliüretan izolasyon.
- 45 derecede sabit kendiliğinden kapanan kapılar.
- Alüminyum panelli,bakır borulu evaporatör.
- Paslanmaz çelik gövde.

English

REFRIGERATED CABINETS (STATIC COOLING)

- For single door; 3 pieces GN 2/1 interior shelve.
- For double doors; 6 pieces GN 2/1 interior shelve.
- Working temperature; 0° C , + 5° C (at ambient temp. 43° C)
- 220 V-230 V -1 +N -50 60 Hz electrical power.
- "CFC Free" , R-134 A gas.
- 40 kg/m3 density.
- Electronic temperature and defrosting control and display.
- Automatic evaporation of water during defrosting.
- Removable,conditioning compressor.
- Static cooling.
- "Ozone-friendly" 48 mm thickness polyurethane isolation.
- Self closing doors.
- Copper tube evaporator with aluminum fins.
- Stainless steel body.



Dik Tip Derin Dondurucu (Statik Soğutma) Freezer Cabinets (Static Cooling)



Kod Code	Ürün Adı Description	Ebatlar Dimension mm			Ağırlık Weight kg	Net Net m³	Güç Power kw	Kapasite Capacity lt	Fiyatı Price Euro
		a	b	c					
EMP.70.80.02-STA	Dik Tip Derin Dondurucu (Tek Kapılı) Freezer Cabinets (Single Door)	700x800x2050			145	1.2	1	700	2.450
EMP.140.80.02-STA	Dik Tip Derin Dondurucu (Çift Kapılı) Freezer Cabinets (Double Door)	1400x800x2050			245	2.4	1.3	1400	3.500

Türkçe

DİK TİP DERİN DONDURUCU (STATİK SOĞUTMA)

- Tek kapılılar için 3 adet GN 2/1 raf.
- Çift kapılılar için 6 adet GN 2/1 raf.
- Derin dondurucu için çalışma aralığı; -18 ° C , -20 ° C .
- 220 V-230 V -1 +N -50 60 Hz elektrik gücü.
- "CFC Free" , 404A soğutucu gaz.
- 40 kg/m3 yoğunluk.
- Elektronik, sıcaklık ve defrost kontrollü göstere.
- Defrost esnasında otomatik su buharlaştırma.
- Sökülebilir havalandırılmalı kompresör.
- Statik soğutma.
- 48 mm kalınlığında "ozon dostu" poliüretan izolasyon.
- 45 derecede sabit kendiliğinden kapanan kapılar.
- Alüminyum panelli,bakır borulu evaporatör.
- Paslanmaz çelik gövde.

English

FREEZER CABINETS (STATIC COOLING)

- For single door; 3 pieces GN 2/1 interior shelve.
- For double doors; 6 pieces GN 2/1 interior shelve.
- Working temperature for freezers; -18° C, -20° C
- 220 V-230 V -1 +N -50 60 Hz electrical power.
- "CFC Free" , 404A gas.
- 40 kg/m3 density.
- Electronic temperature and defrosting control and display.
- Automatic evaporation of water during defrosting.
- Removable, conditioning compressor.
- Static cooling.
- "Ozone-friendly" 48 mm thickness polyurethane isolation.
- Self closing doors.
- Copper tube evaporator with aluminum fins.
- Stainless steel body.



Dik Tip Derin Dondurucu (Fanlı) Freezer Cabinets (Fan Cooling)



Kod Code	Ürün Adı Description	Ebatlar Dimension mm			Ağırlık Weight kg	Net Net m ³	Güç Power kw	Kapasite Capacity lt	Fiyatı Price Euro
		a	b	c					
EMP.70.80.02	Dik Tip Derin Dondurucu (Tek Kapılı) Freezer Cabinets (Single Door)	700x800x2050			145	1.2	1	700	2.000
EMP.140.80.02	Dik Tip Derin Dondurucu (Çift Kapılı) Freezer Cabinets (Double Door)	1400x800x2050			245	2.4	1.3	1400	3.000

Türkçe

DİK TIP DERİN DONDURUCU (STATİK SOĞUTMA)

- Tek kapılılar için 3 adet GN 2/1 raf.
- Çift kapılılar için 6 adet GN 2/1 raf.
- Derin dondurucu için çalışma aralığı:-18 ° C , -20 ° C .
- 220 V-230 V -1 +N -50 60 Hz elektrik gücü.
- "CFC Free" , 404A soğutucu gaz.
- 40 kg/m³ yoğunluk.
- Elektronik, sıcaklık ve defrost kontrollü gösterge.
- Defrost esnasında otomatik su buharlaştırma.
- Sökülebilir havalandırmalı kompresör.
- Fanlı soğutma.
- 48 mm kalınlığında "ozon dostu" poliüretan izolasyon.
- 45 derecede sabit kendiliğinden kapanan kapılar.
- Alüminyum panelli,bakır borulu evaporatör.
- Paslanmaz çelik gövde.

English

FREEZER CABINETS (STATIC COOLING)

- For single door; 3 pieces GN 2/1 interior shelve.
- For double doors; 6 pieces GN 2/1 interior shelve.
- Working temperature for freezers;-18° C,-20° C
- 220 V-230 V -1 +N -50 60 Hz electrical power.
- "CFC Free" , 404A gas.
- 40 kg/m³ density.
- Electronic temperature and defrosting control and display.
- Automatic evaporation of water during defrosting.
- Removable,conditioning compressor.
- Fan cooling.
- "Ozone-friendly" 48 mm thickness polyurethane isolation.
- Self closing doors .
- Copper tube evaporator with aluminum fins.
- Stainless steel body.





Otomatik Programlı Fermantasyon Dolabı (Soğuk - Sıcak) Automatic Programmed Retarder Proofer (Cold - Hot)



Kod Code	Ürün Adı Description	Ebatlar Dimension mm			Ağırlık Weight kg	Net Net m³	Güç Power kw	Kapasite Capacity lt	Fiyatı Price Euro
		a	b	c					
EMP.70.95.AKE	Otomatik Programlı Fermantasyon Dolabı (Soğuk - Sıcak) Automatic Programmed Retarder Proofer (Cold - Hot)	700	800	2050	160	1.2	1.6	700	3.100

Türkçe

OTOMATİK PROGRAMLI FERMANTASYON DOLABI (SOĞUK - SICAK)

- EMP.70.95.AKE için; 20 kat 40x60 tepsi kapasitesi.
- Çalışma aralığı; -10 ° C , + 40 ° C
- Tek başına soğutucu olarak kullanılabılır.
- Tek başına mayalandırma dolabı olarak kullanılabılır.
- Tek başına belirli süreye kadar soğuk, sonrasında mayalandırma dolabı olarak kullanılabılır.
- 220 V-230 V -1 +N -50 60 Hz elektrik gücü.
- "CFC Free" , 404 A soğutucu gaz.
- 40 kg/m3 yoğunluk.
- Elektronik, sıcaklık ve defrost kontrollü göstergesi.
- Defrost esnasında otomatik su buharlaştırma.
- Sökülebilir havalandırma kompresörü.
- Fanlı soğutma.
- 48 mm kalınlığında "ozon dostu" poliüretan izolasyon.
- Alüminyum panelli,bakır borulu evaporatör.
- Paslanmaz çelik gövde.

- Otomatik fermantasyon elektronik kontrolü:
- 1. Faz: Fermantasyonu durdurma süreci (Maksimum 7 gün)
- 2. Faz: 72 Saate kadar muhafaza.
- 3.Faz: Fermantasyon sürecini yeniden başlatma.
- 4.Faz: Sıcaklık kontrollü fermantasyon ve nemlendirme.
- 5.Faz: Nemlendirme sonrası ürün muhafazası.
(Kullanılan ürüne göre 5/10 saat)

Mayalandırma işlemi bittikten sonra istenilen sıcaklıkta sabit tutulabilme özelliği.

Temperature stabilizing option after fermentation proces.

English

AUTOMATIC PROGRAMMED RETARDER PROOVER (COLD - HOT)

- EMP.70.95.AKE; capacity:20 pieces 40x60 trays
- Working temperature; -10° C , + 40° C
- Might operate in purpose of only cooling.
- Might operate in purpose of only fermentation.
- Might operate in purpose of fermentation after cooling.
- 220 V-230 V -1 +N -50 60 Hz electrical power.
- "CFC Free" , 404 A refrigerant gas.
- 40 kg/m3 density.
- Electronic temperature and defrosting control and display
- Automatic evaporation of water during defrosting
- Removable,conditioning compressor
- Fan cooling.
- "Ozone-friendly" 48 mm thickness polyurethane isolation.
- Copper tube evaporator with aluminum fins
- Stainless steel body.

- Electronic control of automatic proofing:
- 1st Phase: Stop proofing proces (not more than 7 days)
- 2st Phase: Conservation up to 72 hours.
- 3st Phase: Restart of proofing process.
- 4st Phase: Proofing and control temperature and humidity.
- 5st Phase: Conservation of product after proofing.
(5/10 hours depending on the product type)

Dik Tip Buzdolapları (Pastane) Refrigerated Cabinets (Patisserie)



Kod Code	Ürün Adı Description	Ebatlar Dimension mm			Ağırlık Weight kg	Net Net m³	Güç Power kw	Kapasite Capacity lt	Fiyatı Price Euro
		a	b	c					
EMP.70.95.01	Dik Tip Buzdolabı-Pastane (Fanlı) Refrigerated Cabinet-Patisserie (With Fan)	700	800	2050	130	1.2	0.4	700	2.000
EMP.70.95.01-STA	Dik Tip Buzdolabı-Pastane (Statik) Refrigerated Cabinet-Patisserie (Static Cooling)	700	800	2050	130	1.2	0.4	700	2.400
EMP.70.95.02-STA	Dik Tip Derin Dondurucu-Pastane (Statik) Freezer Cabinet-Patisserie (Static Cooling)	700	800	2050	145	1.2	1	700	2.900

Türkçe

DİK TİP BUZDOLAPLARI (PASTANE)

- 20 kat 40x60 tepsi kapasitesi.

- Çalışma aralığı; +0 ° C , + 5 ° C (tropikal 43° C)
- Derin dondurucu için çalışma aralığı;-18 ° C ,-20 ° C
- 220 V-230 V -1 +N -50 60 Hz elektrik gücü.
- "CFC Free" , R-134 A , Derin dondurucu için 404 A soğutucu gaz.
- 40 kg/m3 yoğunluk.
- Elektronik, sıcaklık ve defrost kontrollü gösterge.
- Defrost esnasında otomatik su buharlaştırma.
- Sökülebilir havalandırmalı kompresör.
- Statik ve fanlı soğutma.
- 48 mm kalınlığında "ozon dostu" poliüretan izolasyon.
- 45 derecede sabit kendiliğinden kapanan kapılar.
- Alüminyum panelli,bakır borulu evaporatör.
- Paslanmaz çelik gövde.

English

REFRIGERATED CABINETS (PATISSERIE)

- Capacity: 20 pieces 40x60 trays.

- Working temperature; 0° C , + 5° C (at ambient temp.43° C)
- Working temperature for freezers;-18° C,-20° C
- 220 V-230 V -1 +N -50 60 Hz electrical power.
- "CFC Free" , R-134 A for freezer;404 A refrigerant gas
- 40 kg/m3 density.
- Electronic temperature and defrosting control and display.
- Automatic evaporation of water during defrosting.
- Removable,conditioning compressor.
- Fan cooling and static cooling.
- "Ozone-friendly" 48 mm thickness polyurethane isolation.
- Self closing doors .
- Copper tube evaporator with aluminum fins.
- Stainless steel body.





Soğuk Oda Depoları (0° C / +2° C)
Cold Room (0° C / +2° C)



Kod Code	Ürün Adı Description	Ebatlar Dimension mm			Ağırlık Weight kg	Net Net m³	Güç Power kw	Elektrik Gücü Electric Power kw	Soğutma Kapasitesi Cooling Capacity kw	Fiyatı Price Euro
		a	b	c						
EMP.SD.10	Soğuk Oda Paneli+Tavan+Taban+Kapı Cold Room Panel+Ceiling+Base+Door	1780x1780x2450			271	2.77				2.500
EMP.SG.10	Soğuk Oda Soğutma Grubu Refrigeration Unit	SD.10 Grubu For SD.10			47	0.18	1.5	1.62	3.86	2.745
EMP.SD.30	Soğuk Oda Paneli+Tavan+Taban+Kapı Cold Room Panel+Ceiling+Base+Door	2360x2360x2450			394	3.1				3.300
EMP.SG.30	Soğuk Oda Soğutma Grubu Refrigeration Unit	SD.30 Grubu For SD.30			57	0.25	2	2.2	5.03	3.050
EMP.SD.50	Soğuk Oda Paneli+Tavan+Taban+Kapı Cold Room Panel+Ceiling+Base+Door	2360x3550x2450			530	3.7				4.200
EMP.SG.50	Soğuk Oda Soğutma Grubu Refrigeration Unit	SD.50 Grubu For SD.50			77	0.45	2.5	2.33	5.68	3.450
EMP.SD.70	Soğuk Oda Paneli+Tavan+Taban+Kapı Cold Room Panel+Ceiling+Base+Door	3550x3550x2450			702	6				5.330
EMP.SG.70	Soğuk Oda Soğutma Grubu Refrigeration Unit	SD.70 Grubu For SD.70			90	0.5	3	2.33	6.30	3.665
EMP.SD.90	Soğuk Oda Paneli+Tavan+Taban+Kapı Cold Room Panel+Ceiling+Base+Door	4720x3550x2450			870	7.37				6.520
EMP.SG.90	Soğuk Oda Soğutma Grubu Refrigeration Unit	SD.90 Grubu For SD.90			108	1.16	3	3.02	7.26	3.730
EMP.SD.110	Soğuk Oda Paneli+Tavan+Taban+Kapı Cold Room Panel+Ceiling+Base+Door	4720x4720x2450			1073	10.69				7.850
EMP.SG.110	Soğuk Oda Soğutma Grubu Refrigeration Unit	SD.110 Grubu For SD.110			120	1.5	4	4.01	9.01	4.850

- Özel ölçüye göre soğuk oda imal edilir .
- We are able to manufacture cold rooms regarding to specific dimension.

SOĞUK ODA FİYATLARINA PANEL VE SOĞUTMA GRUBU MONTAJ FİYATLARI DAHİL DEĞİLDİR.
INSTALLATION OF COLD ROOMS IS NOT INCLUDED TO THE COLD ROOM PRICES.

Soğuk Oda Depoları (-18° C)
Cold Room (-18° C)



Kod Code	Ürün Adı Description	Ebatlar Dimension mm			Ağırlık Weight kg	Net Net m³	Güç Power kw	Elektrik Gücü Electric Power kw	Soğutma Kapasitesi Cooling Capacity kw	Fiyatı Price Euro
		a	b	c						
EMP.SD.20	Soğuk Oda Paneli+Tavan+Taban+Kapı Cold Room Panel+Ceiling+Base+Door	1780x1780x2450			271	2.77				2.770
EMP.SG.20	Soğuk Oda Soğutma Grubu Refrigeration Unit	SD.20 Grubu For SD.20			47	0.18	1.5	1.22	1.6	2.850
EMP.SD.40	Soğuk Oda Paneli+Tavan+Taban+Kapı Cold Room Panel+Ceiling+Base+Door	2360x2360x2450			394	3.1				3.680
EMP.SG.40	Soğuk Oda Soğutma Grubu Refrigeration Unit	SD.40 Grubu For SD.40			57	0.25	2	1.55	2.18	4.130
EMP.SD.60	Soğuk Oda Paneli+Tavan+Taban+Kapı Cold Room Panel+Ceiling+Base+Door	2360x3550x2450			530	3.7				4.685
EMP.SG.60	Soğuk Oda Soğutma Grubu Refrigeration Unit	SD.60 Grubu For SD.60			77	0.45	3	2.5	3.13	5.555
EMP.SD.80	Soğuk Oda Paneli+Tavan+Taban+Kapı Cold Room Panel+Ceiling+Base+Door	3550x3550x2450			702	6				5.975
EMP.SG.80	Soğuk Oda Soğutma Grubu Refrigeration Unit	SD.80 Grubu For SD.80			90	0.5	3	4.13	4.35	5.555
EMP.SD.100	Soğuk Oda Paneli+Tavan+Taban+Kapı Cold Room Panel+Ceiling+Base+Door	4720x3550x2450			870	7.37				8.040
EMP.SG.100	Soğuk Oda Soğutma Grubu Refrigeration Unit	SD.100 Grubu For SD.100			108	1.16	7	5.62	4.70	7.020
EMP.SD.120	Soğuk Oda Paneli+Tavan+Taban+Kapı Cold Room Panel+Ceiling+Base+Door	4720x4720x2450			1073	10.69				9.430
EMP.SG.120	Soğuk Oda Soğutma Grubu Refrigeration Unit	SD.120 Grubu For SD.120			120	1.5	5	4.13	5.52	8.700

- Özel ölçüye göre soğuk oda imal edilir .
- We are able to manufacture cold rooms regarding to specific dimension.

SOĞUK ODA FİYATLARINA PANEL VE SOĞUTMA GRUBU MONTAJ FİYATLARI DAHİL DEĞİLDİR.
INSTALLATION OF COLD ROOMS IS NOT INCLUDED TO THE COLD ROOM PRICES.



Türkçe

Portatif Soğuk Hava Depoları Genel Özellikleri

- Hafiftir, dayanıklıdır ve montaj kolaylığı sağlar.
- Hazırlanmış olan soğuk hava depolarında et, süt ve diğer tüm gıda maddelerinin en iyi ve en uzun süre muhafaza edilmesini sağlar.
- Elektro statik boyalı saclar RAL 9002 kullanılmaktadır.
- Panel kalınlıklarımız taze muhafaza odalarda 80 mm, donmuş muhafazalarda 120 mm olarak imal edilmektedir.
- Panellerimiz yan yana, birbirine geçmeli, kilitli sistemden oluşturulmaktadır.
- Teknik ekipmanlarla teknik ekip tarafından kurulumu sağlanmaktadır.
- Gaz: 404 A

Soğuk Oda Kapısı Genel Özellikleri

- Kapı iç ve dış yüzeyleri elektro statik boyalı saclar RAL 9002 saçtan mamul olup içi 42 kg/m³ dansitede poliüretan enjeksiyon ile izolasyonludur.
- Kapı kolları kilitlenebilir tip içerden ve dışardan açılabilen emniyet mekanizmalıdır.
- İzolasyon kalınlığı soğuk odalarda 80 mm, donmuş muhafazalarda 120 mm olarak imal edilmektedir.
- Gaz:404 A

Styrofoam/Dow Genel Özellikleri

- Mükemmel ve sürekli ısı yalıtım özelliği
- Suya karşı mükemmel direnç ve sıfır kapillerite
- Dona karşı dayanım
- Yüksek ve uzun süreli basma mukavemeti
- Yüksek elastik modülü
- Kullanım yerine uygun optimum su buharı difüzyon direnci
- Gaz: 404 A

Aksesuarlar

- Köşebent alüminyum
- Köşe plastiği
- Armatür
- Soğuk oda kapı menteşesi
- Soğuk oda kapı kilidi

English

Portable Cold Storages General Features

- It is light, durable and provides montage facility.
- It provides the best and the longest time storage of meat, milk, vegetable and all other food in the cold storages which are prepared.
- RAL 9002 is used with the electrostatic painted sheet metals.
- The thickness of the panel is manufactured as 80 mm with the fresh keeping rooms and 120 mm and 150 mm with the frozen storage rooms.
- Our panels are consisted of the side-by-side, dovetailed to each other and locking system.
- Its installation is made by the technical team using technical equipment.
- Gas: 404 A

Cold Room Door General Features

- The interior and exterior surfaces of the door are made of RAL 9002 electrostatic painted sheet metals and the inside is insulated with 42 kg/m³ density polyurethane injection.
- The door handles are of lockable-type with a safety mechanism that can be opened from inside and outside.
- The insulation thickness is made as 80 mm in the cold rooms and 120 mm and 150 mm in the frozen storages.
- Gas:404 A

Styrofoam/Dow Genel Features

- Perfect and continual heat insulation feature
- Perfect resistance against water and zero capillarity
- Resistance against freezing
- High and long term pressing resistance
- High elastic module
- Optimum water vapor diffusion resistance suitable to the site to be used.
- Gas:404 A

Accessory

- Corner piece aluminum
- Corner plastic
- Armature
- Cold room door hinge
- Cold room door lock

Teşhir
Display



EMPERO
G|R|O|U|P

empero@empero.com.tr



Salat Bar (Nötr) / Buffet Salad Bar (Neutral)

Salat Bar (Soğutmalı) / Buffet Salad Bar (Cold)

Benmariler / Buffet (Hot)

Benmari ve Nötr Servis Üniteleri / Bain marie and Neutral Service Units

Düz Camlı Servis Üniteleri / Flat Glass Service Units

Bombe Camlı Servis Üniteleri / Convex Glass Service Units

Benmari Servis Üniteleri / Bain marie Service Units

Benmari Servis Ünite Aksesuarları / Bain marie Service Unit Accessories

Benmari Servis Ünite Aksesuarları / Bain marie Service Unit Accessories

Benmari Servis Ünite Aksesuarları / Bain marie Service Unit Accessories

Soğuk Servis Üniteleri (Buzdolaplı) / Cold Service Units (Refrigerated)

Soğuk Servis Ünite Aksesuarları / Cold Service Unit Accessories

Soğuk Servis Ünite Aksesuarları / Cold Service Unit Accessories

Soğuk Servis Üniteleri / Cold Service Units

Soğuk Servis Ünite Aksesuarları / Cold Service Unit Accessories



Soğuk Servis Ünite Aksesuarları / Cold Service Unit Accessories

Soğuk Servis Üniteleri / Cold Service Units

Soğuk Servis Ünite Aksesuarları / Cold Service Unit Accessories

Soğuk Servis Üniteleri / Cold Service Units

Soğuk Servis Ünite Aksesuarları / Cold Service Unit Accessories

Ocakbaşı / Display Type Grill

Ocakbaşı Aksesuarları / Display Type Grill Accessories

Nötr Servis Üniteleri / Neutral Service Units

Nötr Servis Ünite Aksesuarları / Neutral Service Unit Accessories

Nötr Servis Ünite Aksesuarları / Neutral Service Unit Accessories

Nötr Servis Ünite Aksesuarları / Neutral Service Unit Accessories

Köşe Tezgahı ve Küver Ünitesi / Corner Service Table and Cutlery Unit

Köşe Tezgahı ve Küver Ünite Aksesuarları / Corner Service Table and Cutlery Unit Accessories

Merkür Et ve Meze Vitrinleri (Bombe Cam) / Mercury Meat and Appetizer Showcases (Convex Glass)

Merkür Et ve Meze Vitrinleri (Düz Cam) / Mercury Meat and Appetizer Showcases (Flat Glass)

Plüton Et ve Meze Teşhir Vitrinleri (Düz Camlı) / Pluton Meat and Appetizer Showcase (Flat Glass)

Plüton Et ve Meze Teşhir Vitrinleri (Bombe Camlı) / Pluton Meat and Appetizer Showcase (Convex Glass)

Venüs Pasta Vitrinleri / Venus Pastry Showcase

Neptün Pasta Vitrinleri / Neptun Pastry Showcase

Salat Bar (Nötr)
Buffet Salad Bar (Neutral)



Kod Code	Ürün Adı Description	Ebatlar Dimension mm			Ağırlık Weight kg	Net Net m³	Fiyatı Price Euro
		a	b	c			
EMP.SB.03-N	Salat Bar - Nötr Buffet Salad Bar - Neutral	1180	890	870/1370	125	1.43	1.350
EMP.SB.04-N	Salat Bar - Nötr Buffet Salad Bar - Neutral	1500	890	870/1370	146	1.82	1.550
EMP.SB.05-N	Salat Bar - Nötr Buffet Salad Bar - Neutral	1800	890	870/1370	163	2.19	1.725
EMP.SB.06-N	Salat Bar - Nötr Buffet Salad Bar - Neutral	2100	890	870/1370	184	2.50	1.950

Türkçe

SALAT BAR (NÖTR)

- Granit üst tabla.
- Aydınlatma Sistemi.
- Opsiyonel ahşap gövde.
- Çıkartılabilir üst servis rafı.

English

BUFFET SALAD BAR (NEUTRAL)

- Granite table top.
- Lightining system.
- Optional wooden body colour.
- Lift-Up Safety Glass Breath Shield.

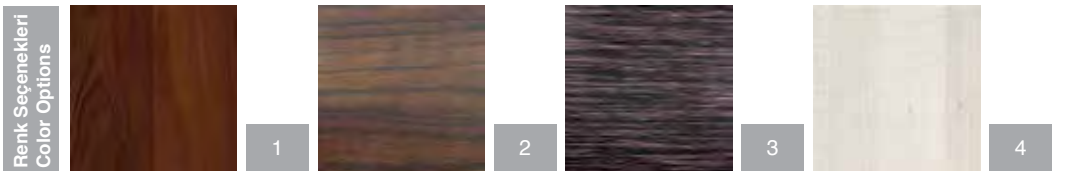

- 1 Montreal/Melamin&Laminant Montreal/Melamine&Laminate 2 Samba Ceviz/Melamin&Laminant Samba Walnut/Melamine&Laminate 3 Venge/Melamin Venge/Melamine 4 Akağaç/Melamin&Laminant Maple/Melamine&Laminate

Salat Bar (Soğutmalı)
Buffet Salad Bar (Cold)



Kod Code	Ürün Adı Description	Ebatlar Dimension mm			Ağırlık Weight kg	Net Net m³	Güç Power kw	Kapasite Capacity	Fiyatı Price Euro
		a	b	c					
EMP.SB.03	Salat Bar-Soğutmalı Buffet Salad Bar -Cold	1180x890x870/1370			125	1.43	1.3	3X1/1 GN	1.800
EMP.SB.04	Salat Bar-Soğutmalı Buffet Salad Bar -Cold	1500x890x870/1370			146	1.82	1.3	4x1/1 GN	1.900
EMP.SB.05	Salat Bar-Soğutmalı Buffet Salad Bar -Cold	1800x890x870/1370			163	2.19	1.3	5x1/1 GN	2.000
EMP.SB.06	Salat Bar-Soğutmalı Buffet Salad Bar -Cold	2100x890x870/1370			184	2.50	1.3	6x1/1 GN	2.500



Türkçe

SALAT BAR (SOĞUTMALI)

- Paslanmaz çelik havuz.
- 220V 50Hz enerji.
- Serpantin soğutma sistemi.
- 40 kg/m3 yoğunluk poliüretan izolasyon.
- Aydınlatma Sistemi.
- R-134 A soğutucu gaz.
- Opsiyonel ahşap gövde.
- Çıkarılabilir üst servis raflı

*Standart üretimimizde küvet bulunmamaktadır.

English

BUFFET SALAD BAR (COLD)

- Stainless steel well.
- 220V 50Hz energy.
- Serpentine cooling system.
- 40 kg/m3 density polyurethane isolation.
- Lightening system.
- Refrigerant gas:R-134 A
- Optional wooden body colour.
- Lift-Up Safety Glass Breath Shield.

*Standart product does not have containers.

Renk Seçenekleri
Color Options



1

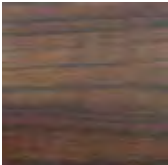

2

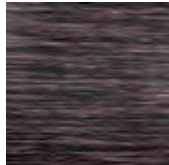

3



4

1 Montreal/Melamin&Laminant
Montreal/Melamine&Laminante

2 Samba Ceviz/Melamin&Laminant
Samba Walnut/Melamine&Laminante

3 Venge/Melamin
Wenge/Melamine

4 Akağaç/Melamin&Laminant
Maple/Melamine&Laminante

Benmariler
Buffet (Hot)



Kod Code	Ürün Adı Description	Ebatlar Dimension mm			Ağırlık Weight kg	Net Net m³	Güç Power kw	Kapasite Capacity	Fiyatı Price Euro
		a	b	c					
EMP.SBS.03	Benmari Buffet-Hot	1180	890	870/1370	125	1.43	2.7	3x1/1 GN	1.350
EMP.SBS.04	Benmari Buffet-Hot	1500	890	870/1370	146	1.82	2.7	4x1/1 GN	1.500
EMP.SBS.05	Benmari Buffet-Hot	1800	890	870/1370	163	2.19	4.3	5x1/1 GN	1.700
EMP.SBS.06	Benmari Buffet-Hot	2100	890	870/1370	184	2.50	5.4	6x1/1 GN	2.100

Türkçe

BENMARI

- Termostatik kumanda.
- 220 V 50 Hz enerji.
- Paslanmaz çelik havuz.
- Su tahliye vanası.
- Aydınlatma Sistemi.
- Opsiyonel ahşap gövde.
- Çıkartılabilir üst servis rafı

*Standart üretimimizde küvet bulunmamaktadır.

English

BUFFET (HOT)

- Thermostatic control.
- Power:220 V 50 Hz
- Stainless steel well.
- Water drainage valve.
- Lightining system.
- Optional wooden body colour.
- Lift-Up Safety Glass Breath Shield.

*Standart product does not have containers.

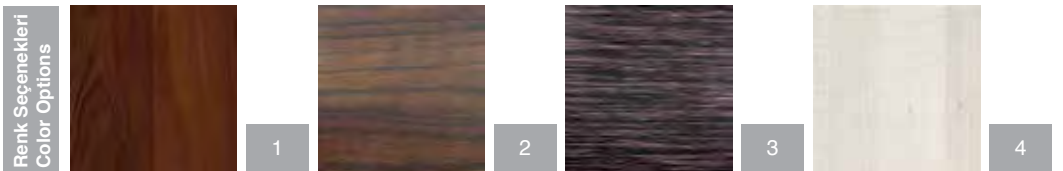

- 1 Montreal/Melamin&Laminant Montreal/Melamine&Laminante 2 Samba Ceviz/Melamin&Laminant Samba Walnut/Melamine&Laminante 3 Venge/Melamin Venge/Melamine 4 Akağaç/Melamin&Laminant Maple/Melamine&Laminante

Benmari ve Nötr Servis Üniteleri Bain marie and Neutral Service Units

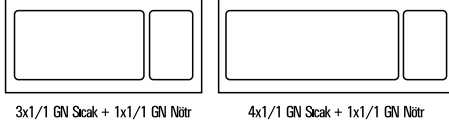

Kod Code	Ürün Adı Description	Ebatlar Dimension mm			Ağırlık Weight kg	Net Net m ³	Güç Power kw	Kapasite Capacity	Fiyatı Price Euro
		a	b	c					
EMP.BEN.31	Servis Ünitesi-Üst Rafı-Sürgü Standlı Service Unit-Top Shelf-Sliding Tray	1500	790	850/1350	99	1.5	2.7	3 Sıcak+1 Nötr/ 3 Hot+1Neutral	2.000
EMP.BEN.41	Servis Ünitesi-Üst Rafı-Sürgü Standlı Service Unit-Top Shelf-Sliding Tray	1800	790	850/1350	118	1.8	2.7	4 Sıcak+1 Nötr/ 4 Hot+1Neutral	2.450
EMP.BEN.31.AD	Servis Ünitesi-Üst Rafı-Sürgü Standlı (Ahşap Dekorlu) Service Unit-Top Shelf-Sliding Tray-(Wooden Decorated)	1500	790	850/1350	99	1.5	2.7	3 Sıcak+1 Nötr/ 3 Hot+1Neutral	2.250
EMP.BEN.41.AD	Servis Ünitesi-Üst Rafı-Sürgü Standlı (Ahşap Dekorlu) Service Unit-Top Shelf-Sliding Tray-(Wooden Decorated)	1800	790	850/1350	118	1.8	2.7	4 Sıcak+1 Nötr/ 4 Hot+1Neutral	2.650
EMP.BKU.10	Küver Ünitesi Service Plate Unit	800	790	850/1350	75	0.8			665
EMP.BKU.10.AH	Küver Ünitesi (Ahşap Dekorlu) Service Plate Unit (Wooden Decorated)	800	790	850/1350	75	0.8			795



EMP.BKU.10.AH

Türkçe

BENMARI VE NÖTR SERVİS ÜNİTELERİ

- Termostatik kumanda.
- 220 V 50 Hz enerji.
- Paslanmaz çelik havuz.
- Su tahliye vanası.
- Aydınlatma Sistemi.
- Opsiyonel ön ahşap giydirme.
- Paslanmaz çelik gövde.

*Standart üretimimizde küvet bulunmamaktadır.

English

BAIN MARIE AND NEUTRAL SERVICE UNITS

- Thermostatic control.
- Power:220 V 50 Hz
- Stainless steel well.
- Water drainage valve.
- Lightning system.
- Optional wooden front surface.
- Stainless steel body.

*Standart product does not have containers.

Renk Seçenekleri
Color Options



1 Koyu Eskitme
Dark Brown



2 Açık Eskitme
Light Brown



3 Venge
Venge



4 Mahon
Rusty

Düz Camlı Servis Üniteleri Flat Glass Service Units



Renk Seçenekleri
Color Options



1 Koyu Eskitme
Dark Brown



2 Açık Eskitme
Light Brown



3 Venge
Venge



4 Mahon
Rusty

Bombe Camlı Servis Üniteleri
Convex Glass Service Units



Renk Seçenekleri
Color Options



1 Koyu Eskitme
Dark Brown



2 Açık Eskitme
Light Brown



3 Venge
Venge



4 Mahon
Rusty

Benmari Servis Üniteleri Bain marie Service Units



Kod Code	Ürün Adı Description	Ebatlar Dimension mm			Ağırlık Weight kg	Net Net m³	Güç Power kw	Kapasite Capacity	Fiyatı Price Euro
		a	b	c					
EMP.BEH.05	Benmari Servis Ünitesi Bain marie Service Units	800x790x850			40	0.55	2.7	2x1/1 GN	1.000
EMP.BEH.10	Benmari Servis Ünitesi Bain marie Service Units	1250x790x850			67	0.8	2.7	3x1/1 GN	1.100
EMP.BEH.30	Benmari Servis Ünitesi Bain marie Service Units	1500x790x850			79	0.95	2.7	4x1/1 GN	1.300
EMP.BEH.50	Benmari Servis Ünitesi Bain marie Service Units	1800x790x850			95	1.2	4.3	5x1/1 GN	1.800
EMP.BEH.70	Benmari Servis Ünitesi Bain marie Service Units	2100x790x850			157	1.3	5.4	6x1/1 GN	2.050

Türkçe

BENMARİLER

- Termostatik kumanda.
- 220 V 50 Hz enerji.
- Paslanmaz çelik havuz.
- Su tahliye vanası.
- Led aydınlatma.
- Opsiyonel ön ahşap giydirme.
- Paslanmaz çelik gövde.

*Standart üretimimizde küvet bulunmamaktadır.

English

BAIN MARIES

- Thermostatic control.
- Power:220 V 50 Hz
- Stainless steel well.
- Water drainage valve.
- Led lightining.
- Optional wooden front surface.
- Stainless steel body.

*Standart product does not have containers.



Ahşap Dekor
Wooden Decorated

Üst Raf Grup
Farkı
Top Shelf Group

Tepsi Kaydırma
Standı
Tray Sliding Stand

Bombe Cam
Convex Glass

Granit Tabla
Granit Table



Renk Seçenekleri
Color Options



1 Koyu Eskitme
Dark Brown



2 Açık Eskitme
Light Brown



3 Venge
Venge



4 Mahon
Rusty

Benmari Servis Ünite Aksesuarları
Bain marie Service Unit Accessories

Kod Code	Ürün Adı Description	Fiyatı Price Euro
EMP.BEH.05.AD	Ahşap Dekor Farkı (EMP.BEH.05) Wooden Decorated (EMP.BEH.05)	125
EMP.BEH.10.AD	Ahşap Dekor Farkı (EMP.BEH.10) Wooden Decorated (EMP.BEH.10)	200
EMP.BEH.30.AD	Ahşap Dekor Farkı (EMP.BEH.30) Wooden Decorated (EMP.BEH.30)	230
EMP.BEH.50.AD	Ahşap Dekor Farkı (EMP.BEH.50) Wooden Decorated (EMP.BEH.50)	270
EMP.BEH.70.AD	Ahşap Dekor Farkı (EMP.BEH.70) Wooden Decorated (EMP.BEH.70)	315



Kod Code	Ürün Adı Description	Ebatlar Dimension mm			Fiyatı Price Euro
		a	b	c	
EMP.BEH.05.USC.Y	Üst Raf Grup Farkı - Yarım Cam (EMP.BEH.05) Top Shelf Group Difference - Half Glass (EMP.BEH.05)	800	440	375	350
EMP.BEH.10.USC.Y	Üst Raf Grup Farkı - Yarım Cam (EMP.BEH.10) Top Shelf Group Difference - Half Glass (EMP.BEH.10)	1250	440	375	380
EMP.BEH.30.USC.Y	Üst Raf Grup Farkı - Yarım Cam (EMP.BEH.30) Top Shelf Group Difference - Half Glass (EMP.BEH.30)	1500	440	375	410
EMP.BEH.50.USC.Y	Üst Raf Grup Farkı - Yarım Cam (EMP.BEH.50) Top Shelf Group Difference - Half Glass (EMP.BEH.50)	1800	440	375	600
EMP.BEH.70.USC.Y	Üst Raf Grup Farkı - Yarım Cam (EMP.BEH.70) Top Shelf Group Difference - Half Glass (EMP.BEH.70)	2100	440	375	670



Kod Code	Ürün Adı Description	Ebatlar Dimension mm			Fiyatı Price Euro
		a	b	c	
EMP.BEH.05.USC.T	Üst Raf Grup Farkı - Tam Cam (EMP.BEH.05) Top Shelf Group Difference - Full Glass (EMP.BEH.05)	800	440	375	350
EMP.BEH.10.USC.T	Üst Raf Grup Farkı - Tam Cam (EMP.BEH.10) Top Shelf Group Difference - Full Glass (EMP.BEH.10)	1250	440	375	380
EMP.BEH.30.USC.T	Üst Raf Grup Farkı - Tam Cam (EMP.BEH.30) Top Shelf Group Difference - Full Glass (EMP.BEH.30)	1500	440	375	410
EMP.BEH.50.USC.T	Üst Raf Grup Farkı - Tam Cam (EMP.BEH.50) Top Shelf Group Difference - Full Glass (EMP.BEH.50)	1800	440	375	600
EMP.BEH.70.USC.T	Üst Raf Grup Farkı - Tam Cam (EMP.BEH.70) Top Shelf Group Difference - Full Glass (EMP.BEH.70)	2100	440	375	670



BEH.30+USC+AD+GT



BEH.30+AD+BC+GT



BEH.30+AD+BC+GT



BEH.30+AD+USC+GT

Benmari Servis Ünite Aksesuarları
Bain marie Service Unit Accessories

Kod Code	Ürün Adı Description	Ebatlar Dimension mm			Fiyatı Price Euro
		a	b	c	
EMP.BEH.05.BC.Y	Bombe Cam Farkı - Yarım Cam (EMP.BEH.05) Convex Glass Difference - Half Glass (EMP.BEH.05)	800	665	440	350
EMP.BEH.10.BC.Y	Bombe Cam Farkı - Yarım Cam (EMP.BEH.10) Convex Glass Difference - Half Glass (EMP.BEH.10)	1250	665	440	380
EMP.BEH.30.BC.Y	Bombe Cam Farkı - Yarım Cam (EMP.BEH.30) Convex Glass Difference - Half Glass (EMP.BEH.30)	1500	665	440	410
EMP.BEH.50.BC.Y	Bombe Cam Farkı - Yarım Cam (EMP.BEH.50) Convex Glass Difference - Half Glass (EMP.BEH.50)	1800	665	440	600
EMP.BEH.70.BC.Y	Bombe Cam Farkı - Yarım Cam (EMP.BEH.70) Convex Glass Difference - Half Glass (EMP.BEH.70)	2100	665	440	670



Kod Code	Ürün Adı Description	Ebatlar Dimension mm			Fiyatı Price Euro
		a	b	c	
EMP.BEH.05.BC.T	Bombe Cam Farkı - Tam Cam (EMP.BEH.05) Convex Glass Difference - Full Glass (EMP.BEH.05)	800	665	440	350
EMP.BEH.10.BC.T	Bombe Cam Farkı - Tam Cam (EMP.BEH.10) Convex Glass Difference - Full Glass (EMP.BEH.10)	1250	665	440	380
EMP.BEH.30.BC.T	Bombe Cam Farkı - Tam Cam (EMP.BEH.30) Convex Glass Difference - Full Glass (EMP.BEH.30)	1500	665	440	410
EMP.BEH.50.BC.T	Bombe Cam Farkı - Tam Cam (EMP.BEH.50) Convex Glass Difference - Full Glass (EMP.BEH.50)	1800	665	440	600
EMP.BEH.70.BC.T	Bombe Cam Farkı - Tam Cam (EMP.BEH.70) Convex Glass Difference - Full Glass (EMP.BEH.70)	2100	665	440	670

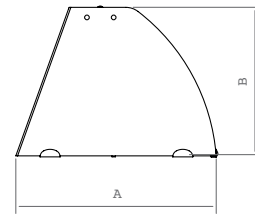

Bombe Cam
Convex Glass

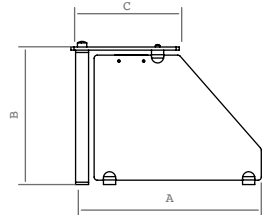

Düz Cam
Flat Glass

Benmari Servis Ünite Aksesuarları

Bain marie Service Unit Accessories

Kod Code	Ürün Adı Description	Fiyatı Price Euro
EMP.BEH.05.TK	Tepsi Kaydırma Standı Farkı (EMP.BEH.05) Tray Sliding Stand Difference (EMP.BEH.05)	200
EMP.BEH.10.TK	Tepsi Kaydırma Standı Farkı (EMP.BEH.10) Tray Sliding Stand Difference (EMP.BEH.10)	250
EMP.BEH.30.TK	Tepsi Kaydırma Standı Farkı (EMP.BEH.30) Tray Sliding Stand Difference (EMP.BEH.30)	275
EMP.BEH.50.TK	Tepsi Kaydırma Standı Farkı (EMP.BEH.50) Tray Sliding Stand Difference (EMP.BEH.50)	325
EMP.BEH.70.TK	Tepsi Kaydırma Standı Farkı (EMP.BEH.70) Tray Sliding Stand Difference (EMP.BEH.70)	400



Kod Code	Ürün Adı Description	Fiyatı Price Euro
EMP.BEH.05.GT	Granit Tabla Farkı (EMP.BEH.05) Granit Table Difference (EMP.BEH.05)	325
EMP.BEH.10.GT	Granit Tabla Farkı (EMP.BEH.10) Granit Table Difference (EMP.BEH.10)	450
EMP.BEH.30.GT	Granit Tabla Farkı (EMP.BEH.30) Granit Table Difference (EMP.BEH.30)	525
EMP.BEH.50.GT	Granit Tabla Farkı (EMP.BEH.50) Granit Table Difference (EMP.BEH.50)	625
EMP.BEH.70.GT	Granit Tabla Farkı (EMP.BEH.70) Granit Table Difference (EMP.BEH.70)	725



Soğuk Servis Üniteleri (Buzdolaplı) Cold Service Units (Refrigerated)



Kod Code	Ürün Adı Description	Ebatlar Dimension mm			Ağırlık Weight kg	Net Net m³	Güç Power kw	Kapasite Capacity	Fiyatı Price Euro
		a	b	c					
EMP.BSS.20	Soğuk Servis Ünitesi - Buzdolaplı Cold Service Unit - Refrigerated	1250x790x850			86	0.8	0.35	3x1/1 GN	1.600
EMP.BSS.40	Soğuk Servis Ünitesi - Buzdolaplı Cold Service Unit - Refrigerated	1500x790x850			100	1	0.45	4x1/1 GN	1.900
EMP.BSS.60	Soğuk Servis Ünitesi - Buzdolaplı Cold Service Unit - Refrigerated	2000x790x850			120	1.2	0.45	5x1/1 GN	2.150
EMP.BSS.80	Soğuk Servis Ünitesi - Buzdolaplı Cold Service Unit - Refrigerated	2555x790x850			140	1.68	0.5	6x1/1 GN	2.800

Türkçe

SOĞUK SERVİS ÜNİTELERİ (BUZDOLAPLI)

- Çalışma aralığı; +0 ° C , + 5 ° C (tropikal 43° C)
- 220 V-230 V -1 +N -50 60 Hz elektrik gücü.
- 404 A soğutucu gaz.
- 40 kg/m3 yoğunluk.
- Elektronik, sıcaklık ve defrost kontrollü gösterge.
- Defrost esnasında otomatik su buharlaştırma.
- Sökülebilir havalandırılmalı kompresör.
- Fanlı soğutma.
- 48 mm kalınlığında "ozon dostu" poliüretan izolasyon.
- 45 derecede sabit kendiliğinden kapanan kapılar.
- Alüminyum panelli,bakır borulu evaporatör.
- Ayarlanabilir , paslanmaz çelik raf yuvaları,plastik kaplama iç raf.
- Opsiyonel ön ahşap giydirme.
- Led aydınlatma.
- Paslanmaz çelik gövde.

*Standart üretimimizde küvet bulunmamaktadır.

English

COLD SERVICE UNITS (REFRIGERATED)

- Working temperature; 0° C , + 5° C (at ambient temp. 43° C)
- 220 V-230 V -1 +N -50 60 Hz electrical power.
- 404 A refrigerant gas.
- 40 kg/m3 density.
- Electronic temperature and defrosting control and display.
- Automatic evaporation of water during defrosting.
- Removable,conditioning compressor.
- Cooling with fan.
- "Ozone-friendly" 48 mm thickness polyurethane isolation.
- Self closing doors.
- Copper tube evaporator with aluminum fins.
- Adjustable,stainless steel shelf housing,plastic coated shelves.
- Optional wooden front surface.
- Led lightining.
- Stainless steel body.

*Standart product does not have containers.

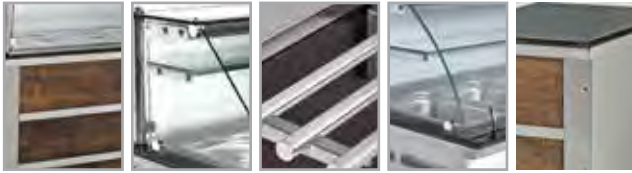

Ahşap Dekor
Wooden Decorated

Üst Raf Grup
Farkı
Top Shelf Group

Tepsi Kaydırma
Standı
Tray Sliding Stand

Bombe Cam
Convex Glass

Granit Tabla
Granit Table



1 Koyu Eskitme
Dark Brown

2 Açık Eskitme
Light Brown

3 Venge
Venge

4 Mahon
Rusty

Soğuk Servis Ünite Aksesuarları Cold Service Unit Accessories

Kod Code	Ürün Adı Description	Fiyatı Price Euro
EMP.BSS.20.AD	Ahşap Dekor Farkı (EMP.BSS.20) Wooden Decorated (EMP.BSS.20)	200
EMP.BSS.40.AD	Ahşap Dekor Farkı (EMP.BSS.40) Wooden Decorated (EMP.BSS.40)	230
EMP.BSS.60.AD	Ahşap Dekor Farkı (EMP.BSS.60) Wooden Decorated (EMP.BSS.60)	315
EMP.BSS.80.AD	Ahşap Dekor Farkı (EMP.BSS.80) Wooden Decorated (EMP.BSS.80)	400



Kod Code	Ürün Adı Description	Ebatlar Dimension mm			Fiyatı Price Euro
		a	b	c	
EMP.BSS.20.USC.Y	Üst Raf Grup Farkı - Yarım Cam (EMP.BSS.20) Top Shelf Group Difference - Half Glass (EMP.BSS.20)	1250	440	375	380
EMP.BSS.40.USC.Y	Üst Raf Grup Farkı - Yarım Cam (EMP.BSS.40) Top Shelf Group Difference - Half Glass (EMP.BSS.40)	1500	440	375	410
EMP.BSS.60.USC.Y	Üst Raf Grup Farkı - Yarım Cam (EMP.BSS.60) Top Shelf Group Difference - Half Glass (EMP.BSS.60)	2000	440	375	670
EMP.BSS.80.USC.Y	Üst Raf Grup Farkı - Yarım Cam (EMP.BSS.80) Top Shelf Group Difference - Half Glass (EMP.BSS.80)	2550	440	375	790



Kod Code	Ürün Adı Description	Ebatlar Dimension mm			Fiyatı Price Euro
		a	b	c	
EMP.BSS.20.USC.T	Üst Raf Grup Farkı - Tam Cam (EMP.BSS.20) Top Shelf Group Difference - Full Glass (EMP.BSS.20)	1250	440	375	380
EMP.BSS.40.USC.T	Üst Raf Grup Farkı - Tam Cam (EMP.BSS.40) Top Shelf Group Difference - Full Glass (EMP.BSS.40)	1500	440	375	410
EMP.BSS.60.USC.T	Üst Raf Grup Farkı - Tam Cam (EMP.BSS.60) Top Shelf Group Difference - Full Glass (EMP.BSS.60)	2000	440	375	670
EMP.BSS.80.USC.T	Üst Raf Grup Farkı - Tam Cam (EMP.BSS.80) Top Shelf Group Difference - Full Glass (EMP.BSS.80)	2550	440	375	790



BSS.40+USC+AD+GT



BSS.40+AD+BC+GT



BSS.40+AD+BC+GT



BSS.40+AD+GT+USC

Soğuk Servis Ünite Aksesuarları
Cold Service Unit Accessories

Kod Code	Ürün Adı Description	Ebatlar Dimension mm			Fiyatı Price Euro
		a	b	c	
EMP.BSS.20.BC.Y	Bombe Cam Farkı - Yarım Cam (EMP.BSS.20) Convex Glass Difference - Half Glass (EMP.BSS.20)	1250	665	440	380
EMP.BSS.40.BC.Y	Bombe Cam Farkı - Yarım Cam (EMP.BSS.40) Convex Glass Difference - Half Glass (EMP.BSS.40)	1500	665	440	410
EMP.BSS.60.BC.Y	Bombe Cam Farkı - Yarım Cam (EMP.BSS.60) Convex Glass Difference - Half Glass (EMP.BSS.60)	2000	665	440	670
EMP.BSS.80.BC.Y	Bombe Cam Farkı - Yarım Cam (EMP.BSS.80) Convex Glass Difference - Half Glass (EMP.BSS.80)	2550	665	440	790



Kod Code	Ürün Adı Description	Ebatlar Dimension mm			Fiyatı Price Euro
		a	b	c	
EMP.BSS.20.BC.T	Bombe Cam Farkı - Tam Cam (EMP.BSS.20) Convex Glass Difference - Full Glass (EMP.BSS.20)	1250	665	440	380
EMP.BSS.40.BC.T	Bombe Cam Farkı - Tam Cam (EMP.BSS.40) Convex Glass Difference - Full Glass (EMP.BSS.40)	1500	665	440	410
EMP.BSS.60.BC.T	Bombe Cam Farkı - Tam Cam (EMP.BSS.60) Convex Glass Difference - Full Glass (EMP.BSS.60)	2000	665	440	670
EMP.BSS.80.BC.T	Bombe Cam Farkı - Tam Cam (EMP.BSS.80) Convex Glass Difference - Full Glass (EMP.BSS.80)	2550	665	440	790



Kod Code	Ürün Adı Description	Fiyatı Price Euro
EMP.BSS.20.TK	Tepsi Kaydırma Standı Farkı (EMP.BSS.20) Tray Sliding Stand Difference (EMP.BSS.20)	250
EMP.BSS.40.TK	Tepsi Kaydırma Standı Farkı (EMP.BSS.40) Tray Sliding Stand Difference (EMP.BSS.40)	275
EMP.BSS.60.TK	Tepsi Kaydırma Standı Farkı (EMP.BSS.60) Tray Sliding Stand Difference (EMP.BSS.60)	400
EMP.BSS.80.TK	Tepsi Kaydırma Standı Farkı (EMP.BSS.80) Tray Sliding Stand Difference (EMP.BSS.80)	525



Kod Code	Ürün Adı Description	Fiyatı Price Euro
EMP.BSS.20.GT	Granit Tabla Farkı (EMP.BSS.20) Granit Table Difference (EMP.BSS.20)	450
EMP.BSS.40.GT	Granit Tabla Farkı (EMP.BSS.40) Granit Table Difference (EMP.BSS.40)	525
EMP.BSS.60.GT	Granit Tabla Farkı (EMP.BSS.60) Granit Table Difference (EMP.BSS.60)	725
EMP.BSS.80.GT	Granit Tabla Farkı (EMP.BSS.80) Granit Table Difference (EMP.BSS.80)	875

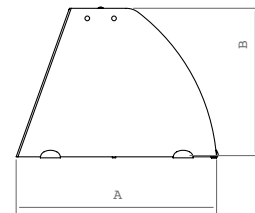

Bombe Cam
Convex Glass

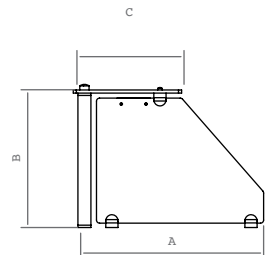

Düz Cam
Flat Glass

Soğuk Servis Üniteleri
Cold Service Units



Kod Code	Ürün Adı Description	Ebatlar Dimension mm			Ağırlık Weight kg	Net Net m ³	Güç Power kw	Kapasite Capacity	Fiyatı Price Euro
		a	b	c					
EMP.BSSD.10S	Soğuk Servis Ünitesi Cold Service Unit	1500x790x850			86	0.8	0.45	3x1/1 GN	1.900
EMP.BSSD.50S	Soğuk Servis Ünitesi Cold Service Unit	2000x790x850			100	1	0.45	4x1/1 GN	2.200
EMP.BSSD.90S	Soğuk Servis Ünitesi Cold Service Unit	2550x790x850			120	1.68	0.50	5x1/1 GN	2.800

Türkçe

SOĞUK SERVİS ÜNİTELERİ

- Çalışma aralığı; +0 °C , + 5 ° C(tropikal 43° C)
- 220 V-230 V -1 +N -50 60 Hz elektrik gücü.
- 404 A soğutucu gaz.
- 40 kg/m³ yoğunluk.
- Elektronik, sıcaklık ve defrost kontrollü gösterge.
- Defrost esnasında otomatik su buharlaştırma.
- Sökülebilir havalandırmalı kompresör.
- Fanlı soğutma.
- 48 mm kalınlığında "ozon dostu" poliüretan izolasyon.
- 45 derecede sabit kendiliğinden kapanan kapılar.
- Alüminyum panelli,bakır borulu evaporatör.
- Ayarlanabilir , paslanmaz çelik raf yuvaları,plastik kaplama iç raf.
- Opsiyonel ön ahşap giydirme.
- Led aydınlatma.
- Paslanmaz çelik gövde.

*Standart üretimimizde küvet bulunmamaktadır.

English

COLD SERVICE UNITS

- Working temperature; 0° C , + 5° C (at ambient temp. 43° C)
- 220 V-230 V -1 +N -50 60 Hz electrical power.
- 404 A refrigerant gas.
- 40 kg/m³ density.
- Electronic temperature and defrosting control and display.
- Automatic evaporation of water during defrosting.
- Removable,conditioning compressor.
- Cooling with fan.
- "Ozone-friendly" 48 mm thickness polyurethane isolation.
- Self closing doors.
- Copper tube evaporator with aluminum fins.
- Adjustable,stainless steel shelf housing,plastic coated shelves.
- Optional wooden front surface.
- Led lightining.
- Stainless steel body.

*Standart product does not have containers.



Ahşap Dekor
Wooden Decorated

Üst Raf Grup Farkı
Top Shelf Group

Tepsi Kaydırma Standı
Tray Sliding Stand

Bombe Cam
Convex Glass

Granit Tabla
Granit Table

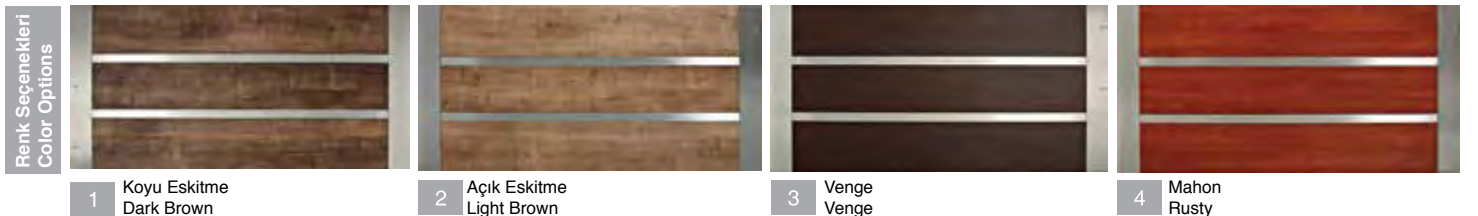

Renk Seçenekleri
Color Options

1 Koyu Eskitme
Dark Brown

2 Açık Eskitme
Light Brown

3 Venge
Venge

4 Mahon
Rusty

Soğuk Servis Ünite Aksesuarları
Cold Service Unit Accessories

Kod Code	Ürün Adı Description	Fiyatı Price Euro
EMP.BSSD.10S.AD	Ahşap Dekor Farkı (EMP.BSSD.10S) Wooden Decorated (EMP.BSSD.10S)	230
EMP.BSSD.50S.AD	Ahşap Dekor Farkı (EMP.BSSD.50S) Wooden Decorated (EMP.BSSD.50S)	315
EMP.BSSD.90S.AD	Ahşap Dekor Farkı (EMP.BSSD.90S) Wooden Decorated (EMP.BSSD.90S)	400



Kod Code	Ürün Adı Description	Ebatlar Dimension mm			Fiyatı Price Euro
		a	b	c	
EMP.BSSD.10S.USC.Y	Üst Raf Grup Farkı - Yarım Cam (EMP.BSSD.10S) Top Shelf Group Difference - Half Glass (EMP.BSSD.10S)	1100x440x375			380
EMP.BSSD.50S.USC.Y	Üst Raf Grup Farkı - Yarım Cam (EMP.BSSD.50S) Top Shelf Group Difference - Half Glass (EMP.BSSD.50S)	1600x440x375			410
EMP.BSSD.90S.USC.Y	Üst Raf Grup Farkı - Yarım Cam (EMP.BSSD.90S) Top Shelf Group Difference - Half Glass (EMP.BSSD.90S)	2150x440x375			670



Kod Code	Ürün Adı Description	Ebatlar Dimension mm			Fiyatı Price Euro
		a	b	c	
EMP.BSSD.10S.USC.T	Üst Raf Grup Farkı - Tam Cam (EMP.BSSD.10S) Top Shelf Group Difference - Full Glass (EMP.BSSD.10S)	1100x440x375			380
EMP.BSSD.50S.USC.T	Üst Raf Grup Farkı - Tam Cam (EMP.BSSD.50S) Top Shelf Group Difference - Full Glass (EMP.BSSD.50S)	1600x440x375			410
EMP.BSSD.90S.USC.T	Üst Raf Grup Farkı - Tam Cam (EMP.BSSD.90S) Top Shelf Group Difference - Full Glass (EMP.BSSD.90S)	2150x440x375			670



Soğuk Servis Ünite Aksesuarları
Cold Service Unit Accessories

Kod Code	Ürün Adı Description	Ebatlar Dimension mm			Fiyatı Price Euro
		a	b	c	
EMP.BSSD.10S.BC.Y	Bombe Cam Farkı - Yarım Cam (EMP.BSSD.10S) Convex Glass Difference - Half Glass (EMP.BSSD.10S)	1100	440	375	380
EMP.BSSD.50S.BC.Y	Bombe Cam Farkı - Yarım Cam (EMP.BSSD.50S) Convex Glass Difference - Half Glass (EMP.BSSD.50S)	1600	440	375	410
EMP.BSSD.90S.BC.Y	Bombe Cam Farkı - Yarım Cam (EMP.BSSD.90S) Convex Glass Difference - Half Glass (EMP.BSSD.90S)	2150	440	375	670



Kod Code	Ürün Adı Description	Ebatlar Dimension mm			Fiyatı Price Euro
		a	b	c	
EMP.BSSD.10S.BC.T	Bombe Cam Farkı - Tam Cam (EMP.BSSD.10S) Convex Glass Difference - Full Glass (EMP.BSSD.10S)	1100	440	375	380
EMP.BSSD.50S.BC.T	Bombe Cam Farkı - Tam Cam (EMP.BSSD.50S) Convex Glass Difference - Full Glass (EMP.BSSD.50S)	1600	440	375	410
EMP.BSSD.90S.BC.T	Bombe Cam Farkı - Tam Cam (EMP.BSSD.90S) Convex Glass Difference - Full Glass (EMP.BSSD.90S)	2150	440	375	670



Kod Code	Ürün Adı Description	Fiyatı Price Euro
EMP.BSSD.10S.TK	Tepsi Kaydırma Standı Farkı (EMP.BSSD.10S) Tray Sliding Stand Difference (EMP.BSSD.10S)	275
EMP.BSSD.50S.TK	Tepsi Kaydırma Standı Farkı (EMP.BSSD.50S) Tray Sliding Stand Difference (EMP.BSSD.50S)	400
EMP.BSSD.90S.TK	Tepsi Kaydırma Standı Farkı (EMP.BSSD.90S) Tray Sliding Stand Difference (EMP.BSSD.90S)	525



Kod Code	Ürün Adı Description	Fiyatı Price Euro
EMP.BSSD.10S.GT	Granit Tabla Farkı (EMP.BSSD.10S) Granit Table Difference (EMP.BSSD.10S)	525
EMP.BSSD.50S.GT	Granit Tabla Farkı (EMP.BSSD.50S) Granit Table Difference (EMP.BSSD.50S)	725
EMP.BSSD.90S.GT	Granit Tabla Farkı (EMP.BSSD.90S) Granit Table Difference (EMP.BSSD.90S)	875

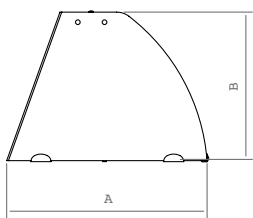

Bombe Cam
Convex Glass

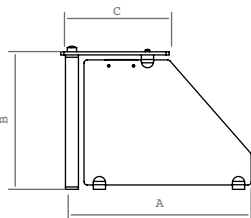

Düz Cam
Flat Glass



BSSD.50S+AD+USC+GT

Soğuk Servis Üniteleri
Cold Service Units



EMP.BSSO.MC.10



Kod Code	Ürün Adı Description	Ebatlar Dimension mm			Ağırlık Weight kg	Net Net m³	Güç Power kw	Kapasite Capacity lt	Fiyatı Price Euro
		a	b	c					
EMP.BSSO.MC.10	Soğuk Servis Ünitesi Buzdolabı (Üç Kapılı) Refrigerated Cold Service Unit (Triple Doors)	2100	880	850	270	1.57	0.45	500	3.030
EMP.BSSO.MC.20	Soğuk Servis Ünitesi Buzdolabı (Dört Kapılı) Refrigerated Cold Service Unit (Four Doors)	2650	880	850	310	1.98	0.5	700	3.460

Türkçe

SOĞUK SERVİS ÜNİTESİ BUZDOLABI

- 2100 mm'de 1/4-150 10 adet Gn.Küvet kapasiteli.
- 2600 mm'de 1/4-150 10 adet Gn.Küvet kapasiteli.
- 2 adet 400x600 mm mayalandırma çekmecesi.
- Her kapakta 4 adet 400x600 mm tepsi kapasitesi.
- Çalışma aralığı: +0 ° C , + 5 ° C (tropikal 43° C)
- 220 V-230 V -1 +N -50 60 Hz elektrik gücü.
- "CFC FREE" , 404 A soğutucu gaz.
- 40 kg/m³ yoğunluk.
- Elektronik, sıcaklık ve defrost kontrollü gösterge.
- Defrost esnasında otomatik su buharlaştırma.
- Sökülebilir havalandırılmalı kompresör.
- Fanlı soğutma.
- 48 mm kalınlığında "ozon dostu" poliüretan izolasyon.
- 45 derecede sabit kendiliğinden kapanan kapılar.
- Alüminyum panelli, bakır borulu evaporatör.
- Ayarlanabilir, paslanmaz çelik raf yuvaları, plastik kaplama iç raf.
- Led aydınlatma.
- Opsiyonel ön ahşap giydirme.

*Standart üretimimizde küvet bulunmamaktadır.

English

REFRIGERATED COLD SERVICE UNIT

- Capacity for 3 door refrigerator:10 pieces of 1/4-150 gastronorm container.
- Capacity for 4 door refrigerator:10 pieces of 1/4-150 gastronorm container.
- Fermentation drawer capacity: 2 pieces 400x600 mm.
- Tray grid capacity: 4 pieces 400x600 mm for each.
- Working temperature: +0 ° C , + 5 ° C (at ambient temp. 43° C)
- 220 V-230 V -1 +N -50 60 Hz electrical power.
- "CFC Free" , 404 A refrigerated gas.
- 40 kg/m³ yoğunluk.
- Electronic temperature and defrosting control and display.
- Automatic evaporation of water during defrosting.
- Removable, conditioning compressor.
- Fan cooling.
- "Ozone - Friendly" 48 mm thickness polyurethane isolation.
- Self closing doors.
- Copper tube evaporator with aluminum fins.
- Adjustable, stainless steel shelf housing, plastic coated shelves.
- Led lighting.
- Optional Wooden front surface.

*Standart product does not have containers.

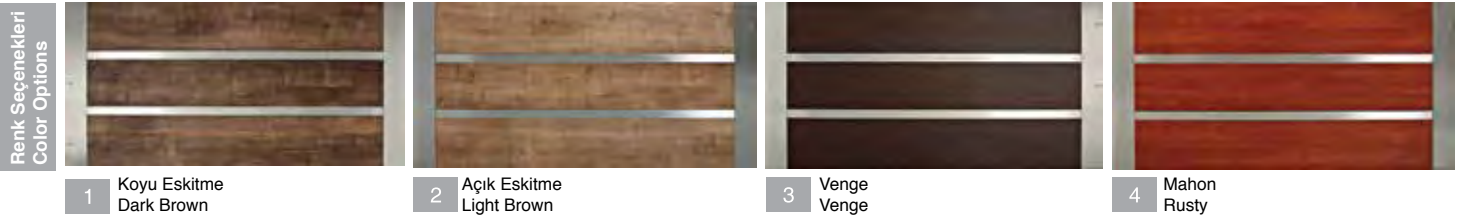

Renk Seçenekleri
Color Options

1 Koyu Eskitme
Dark Brown

2 Açık Eskitme
Light Brown

3 Venge
Venge

4 Mahon
Rusty

Soğuk Servis Ünite Aksesuarları
Cold Service Unit Accessories

Kod Code	Ürün Adı Description	Fiyatı Price Euro
EMP.BSSO.MC.10.AD	Ahşap Dekor Farkı (EMP.BSSO.MC.10.AD) Wooden Decorated (EMP.BSSO.MC.10.AD)	315
EMP.BSSO.MC.20.AD	Ahşap Dekor Farkı (EMP.BSSO.MC.20.AD) Wooden Decorated (EMP.BSSO.MC.20.AD)	400



Kod Code	Ürün Adı Description	Ebatlar Dimension mm	Fiyatı Price Euro
		a	
EMP.BSSO.MC.10. USC.Y	Üst Raf Grup Farkı - Yarım Cam (EMP.BSSO.MC.10.USC.Y) Top Shelf Group Difference - Half Glass (EMP.BSSO.MC.10.USC.Y)	2100x440x375	670
EMP.BSSO.MC.20. USC.Y	Üst Raf Grup Farkı - Yarım Cam (EMP.BSSO.MC.20.USC.Y) Top Shelf Group Difference - Half Glass (EMP.BSSO.MC.20.USC.Y)	2600x440x375	790



Kod Code	Ürün Adı Description	Ebatlar Dimension mm	Fiyatı Price Euro
		a	
EMP.BSSO.MC.10. USC.T	Üst Raf Grup Farkı - Tam Cam (EMP.BSSO.MC.10.USC.T) Top Shelf Group Difference - Full Glass (EMP.BSSO.MC.10.USC.T)	2100x440x375	670
EMP.BSSO.MC.20. USC.T	Üst Raf Grup Farkı - Tam Cam (EMP.BSSO.MC.20.USC.T) Top Shelf Group Difference - Full Glass (EMP.BSSO.MC.20.USC.T)	2600x440x375	790



Kod Code	Ürün Adı Description	Fiyatı Price Euro
EMP.BSSO.MC.10.TK	Tepsi Kaydırma Standı Farkı (EMP.BSSO.MC.10.TK) Tray Sliding Stand Difference (EMP.BSSO.MC.10.TK)	400
EMP.BSSO.MC.20.TK	Tepsi Kaydırma Standı Farkı (EMP.BSSO.MC.20.TK) Tray Sliding Stand Difference (EMP.BSSO.MC.20.TK)	550

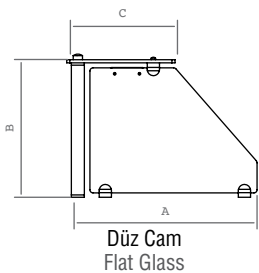

BSSO.MC.010+AD+USC.T



BSSO.MC.010+AD+USC.T

Soğuk Servis Üniteleri
Cold Service Units



EMP.BSSO.10



Kod Code	Ürün Adı Description	Ebatlar Dimension mm			Ağırlık Weight kg	Net Net m³	Güç Power kw	Kapasite Capacity lt	Fiyatı Price Euro
		a	b	c					
EMP.BSSO.10	Soğuk Servis Ünitesi Buzdolabı (Üç Kapılı) Refrigerated Cold Service Unit (Triple Doors)	2100	880	850	270	1.57	0.45	500	2.730
EMP.BSSO.20	Soğuk Servis Ünitesi Buzdolabı (Dört Kapılı) Refrigerated Cold Service Unit (Four Doors)	2600	880	850	310	1.98	0.50	700	3.110

Türkçe

SOĞUK SERVİS ÜNİTESİ BUZDOLABI

- 2100 mm'de 1/4-150 12 adet Gn.Küvet kapasiteli.
- 2600 mm'de 1/4-150 15 adet Gn.Küvet kapasiteli.
- Her kapakta 4 adet 400x600 mm tepsi kapasitesi.
- Çalışma aralığı: +0 ° C , + 5 ° C (tropikal 43° C)
- 220 V-230 V -1 +N -50 60 Hz elektrik gücü.
- "CFC FREE" , 404 A soğutucu gaz.
- 40 kg/m³ yoğunluk.
- Elektronik, sıcaklık ve defrost kontrollü gösterge.
- Defrost esnasında otomatik su buharlaştırma.
- Sökülebilir havalandırmalı kompresör.
- Fanlı soğutma.
- 48 mm kalınlığında "ozon dostu" poliüretan izolasyon.
- 45 derecede sabit kendiliğinden kapanan kapılar.
- Alüminyum panelli, bakır borulu evaporatör.
- Ayarlanabilir, paslanmaz çelik raf yuvaları, plastik kaplama iç raf.
- Led aydınlatma.
- Opsiyonel ön aışap giydirme.

*Standart üretimimizde küvet bulunmamaktadır.

English

REFRIGERATED COLD SERVICE UNIT

- Capacity for 3 door refrigerator:12 pieces of 1/4-150 gastronorm container.
- Capacity for 4 door refrigerator:15 pieces of 1/4-150 gastronorm container.
- Tray grid capacity: 4 pieces 400x600 mm for each.
- Working temperature: +0 ° C , + 5 ° C (at ambient temp. 43° C)
- 220 V-230 V -1 +N -50 60 Hz electrical power.
- "CFC Free" , 404 A refrigerated gas.
- 40 kg/m³ yoğunluk.
- Elektronik temperature and defrosting control and display.
- Automatic evaporation of water during defrosting.
- Removable, conditioning compressor.
- Fan cooling.
- "Ozone - Friendly" 48 mm thickness polyurethane isolation.
- Self closing doors.
- Copper tube evaporator with aluminum fins.
- Adjustable, stainless steel shelf housing, plastic coated shelves.
- Led lighting.
- Optional Wooden front surface.

*Standart product does not have containers.

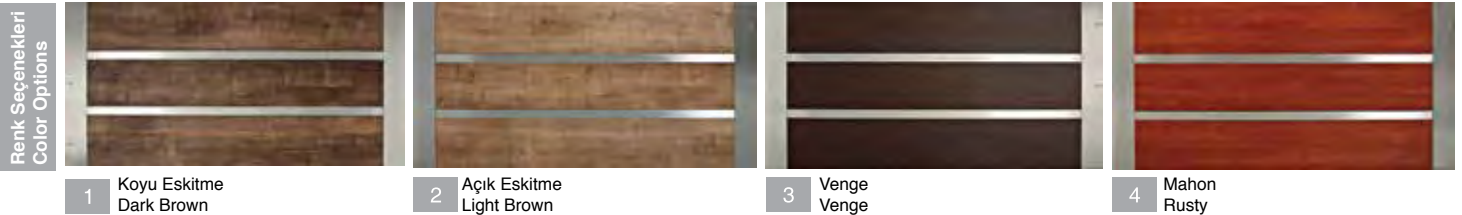

Soğuk Servis Ünite Aksesuarları
Cold Service Unit Accessories

Kod Code	Ürün Adı Description	Fiyatı Price Euro
EMP.BSSO.10.AD	Ahşap Dekor Farkı (EMP.BSSO.10.AD) Wooden Decorated (EMP.BSSO.10.AD)	315
EMP.BSSO.20.AD	Ahşap Dekor Farkı (EMP.BSSO.20.AD) Wooden Decorated (EMP.BSSO.20.AD)	400



Kod Code	Ürün Adı Description	Ebatlar Dimension mm			Fiyatı Price Euro
		a	b	c	
EMP.BSSO.10.USC.Y	Üst Raf Grup Farkı - Yarım Cam (EMP.BSSO.10.USC.Y) Top Shelf Group Difference - Half Glass (EMP.BSSO.10.USC.Y)	2100x440x375			670
EMP.BSSO.20.USC.Y	Üst Raf Grup Farkı - Yarım Cam (EMP.BSSO.20.USC.Y) Top Shelf Group Difference - Half Glass (EMP.BSSO.20.USC.Y)	2600x440x375			790



Kod Code	Ürün Adı Description	Ebatlar Dimension mm			Fiyatı Price Euro
		a	b	c	
EMP.BSSO.10.USC.T	Üst Raf Grup Farkı - Tam Cam (EMP.BSSO.10.USC.T) Top Shelf Group Difference - Full Glass (EMP.BSSO.10.USC.T)	2100x440x375			670
EMP.BSSO.20.USC.T	Üst Raf Grup Farkı - Tam Cam (EMP.BSSO.20.USC.T) Top Shelf Group Difference - Full Glass (EMP.BSSO.20.USC.T)	2600x440x375			790



Kod Code	Ürün Adı Description	Fiyatı Price Euro
EMP.BSSO.10.TK	Tepsi Kaydırma Standı Farkı (EMP.BSSO.10.TK) Tray Sliding Stand Difference (EMP.BSSO.10.TK)	400
EMP.BSSO.20.TK	Tepsi Kaydırma Standı Farkı (EMP.BSSO.20.TK) Tray Sliding Stand Difference (EMP.BSSO.20.TK)	550

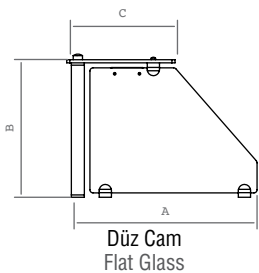

Düz Cam
Flat Glass



EMP.BSSO.10+AD+ USC.T



EMP.BSSO.10+AD+ USC.T

Ocakbaşı
Display Type Grill

Kod Code	Ürün Adı Description	Ebatlar Dimension mm			Ağırlık Weight kg	Net Net m³	Kapasite Capacity Izgara / Grill (cm)	Fiyatı Price Euro
		a	b	c				
EMP.OCK.010	Ocakbaşı Display Type Grill	960x790x2100			225	1.95	80	3.000
EMP.OCK.020	Ocakbaşı Display Type Grill	1360x790x2100			290	2.75	120	3.300
EMP.OCK.030	Ocakbaşı Display Type Grill	1760x790x2100			355	3.55	160	3.900

Türkçe

OCAKBAŞI

- Ateş tuğlalı kömür ızgarası.
- Temperli cam.
- Filtreli davlumbaz.
- Çekmeceli kömür deposu.
- Paslanmaz çelik gövde.

English

DISPLAY TYPE GRILL

- Coal grill firebrick.
- Tempered glass.
- Hood with filter.
- Coal drawer.
- Stainless steel body.

**KÖMÜRLÜ IZGARA YERİNE LAVATAŞLI VEYA SULU IZGARA KOYABİLME OPSİYONU.
INSTEAD OF COAL GRILL, VAPOR GRILL OR LAVASTONE GRILL OPTION.**

Renk Seçenekleri
Color Options1 Koyu Eskitme
Dark Brown2 Açık Eskitme
Light Brown3 Venge
Venge4 Mahon
Rusty

Ocakbaşı Aksesuarları Display Type Grill Accessories

Kod Code	Ürün Adı Description	Fiyatı Price Euro
EMP.OCK.010.AD	Ahşap Dekor Farkı (EMP.OCK.010) Wooden Decorated (EMP.OCK.010)	175
EMP.OCK.020.AD	Ahşap Dekor Farkı (EMP.OCK.020) Wooden Decorated (EMP.OCK.020)	225
EMP.OCK.030.AD	Ahşap Dekor Farkı (EMP.OCK.030) Wooden Decorated (EMP.OCK.030)	300



Kod Code	Ürün Adı Description	Fiyatı Price Euro
EMP.OCK.010.GT	Granit Tabla Farkı (EMP.OCK.010) Granit Table Difference (EMP.OCK.010)	175
EMP.OCK.020.GT	Granit Tabla Farkı (EMP.OCK.020) Granit Table Difference (EMP.OCK.020)	190
EMP.OCK.030.GT	Granit Tabla Farkı (EMP.OCK.030) Granit Table Difference (EMP.OCK.030)	220



Kod Code	Ürün Adı Description	Fiyatı Price Euro
EMP.OCK.010.BR	Bakır Davlumbaz Farkı (EMP.OCK.010) Granit Table Difference (EMP.OCK.010)	545
EMP.OCK.020.BR	Bakır Davlumbaz Farkı (EMP.OCK.020) Granit Table Difference (EMP.OCK.020)	770
EMP.OCK.030.BR	Bakır Davlumbaz Farkı (EMP.OCK.030) Granit Table Difference (EMP.OCK.030)	960



Nötr Servis Üniteleri
Neutral Service Units



Kod Code	Ürün Adı Description	Ebatlar Dimension mm			Ağırlık Weight kg	Net Net m³	Fiyatı Price Euro
		a	b	c			
EMP.NS.10	Nötr Servis Ünitesi Neutral Service Units	600x790x850			66	0.4	450
EMP.NS.30	Nötr Servis Ünitesi Neutral Service Units	900x790x850			70	0.6	500
EMP.NS.50	Nötr Servis Ünitesi Neutral Service Units	1150x790x850			85	0.8	600
EMP.NS.70	Nötr Servis Ünitesi Neutral Service Units	1500x790x850			95	1	700
EMP.NS.90	Nötr Servis Ünitesi Neutral Service Units	1800x790x850			105	1.2	800

Türkçe

NÖTR SERVİS ÜNİTESİ

- Ayarlanabilir ayaklar.
- Opsiyonel ön ahşap giydirme.
- Led aydınlatma.
- Paslanmaz çelik gövde.

English

NEUTRAL SERVICE UNITS

- Adjustable feet.
- Optional wooden front surface.
- Led lightining.
- Stainless steel body.



EMP.NS.10+AD+GT

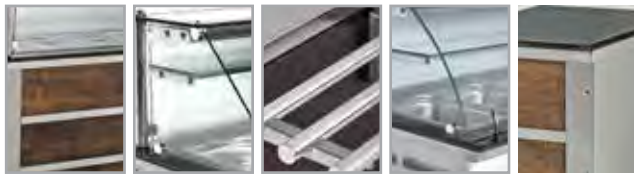

Ahşap Dekor
Wooden Decorated

Üst Raf Grup
Farklı
Top Shelf Group

Tepsi Kaydırma
Standı
Tray Sliding Stand

Bombe Cam
Convex Glass

Granit Tabla
Granit Table

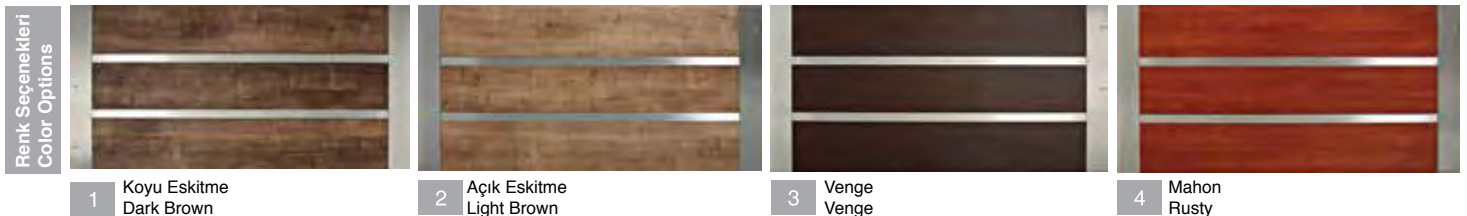

Nötr Servis Ünite Aksesuarları Neutral Service Unit Accessories

Kod Code	Ürün Adı Description	Fiyatı Price Euro
EMP.NS.10.AD	Ahşap Dekor Farkı (EMP.NS.10) Wooden Decorated (EMP.NS.10)	115
EMP.NS.30.AD	Ahşap Dekor Farkı (EMP.NS.30) Wooden Decorated (EMP.NS.30)	135
EMP.NS.50.AD	Ahşap Dekor Farkı (EMP.NS.50) Wooden Decorated (EMP.NS.50)	200
EMP.NS.70.AD	Ahşap Dekor Farkı (EMP.NS.70) Wooden Decorated (EMP.NS.70)	230
EMP.NS.90.AD	Ahşap Dekor Farkı (EMP.NS.90) Wooden Decorated (EMP.NS.90)	270



Kod Code	Ürün Adı Description	Ebatlar Dimension mm			Fiyatı Price Euro
		a	b	c	
EMP.NS.10.USC.Y	Üst Raf Grup Farkı - Yarım Cam (EMP.NS.10) Top Shelf Group Difference - Half Glass (EMP.NS.10)	600x440x375			300
EMP.NS.30.USC.Y	Üst Raf Grup Farkı - Yarım Cam (EMP.NS.30) Top Shelf Group Difference - Half Glass (EMP.NS.30)	900x440x375			350
EMP.NS.50.USC.Y	Üst Raf Grup Farkı - Yarım Cam (EMP.NS.50) Top Shelf Group Difference - Half Glass (EMP.NS.50)	1150x440x375			380
EMP.NS.70.USC.Y	Üst Raf Grup Farkı - Yarım Cam (EMP.NS.70) Top Shelf Group Difference - Half Glass (EMP.NS.70)	1500x440x375			410
EMP.NS.90.USC.Y	Üst Raf Grup Farkı - Yarım Cam (EMP.NS.90) Top Shelf Group Difference - Half Glass (EMP.NS.90)	1800x440x375			600



Kod Code	Ürün Adı Description	Ebatlar Dimension mm			Fiyatı Price Euro
		a	b	c	
EMP.NS.10.USC.T	Üst Raf Grup Farkı - Tam Cam (EMP.NS.10) Top Shelf Group Difference - Full Glass (EMP.NS.10)	600x440x375			300
EMP.NS.30.USC.T	Üst Raf Grup Farkı - Tam Cam (EMP.NS.30) Top Shelf Group Difference - Full Glass (EMP.NS.30)	900x440x375			350
EMP.NS.50.USC.T	Üst Raf Grup Farkı - Tam Cam (EMP.NS.50) Top Shelf Group Difference - Full Glass (EMP.NS.50)	1150x440x375			380
EMP.NS.70.USC.T	Üst Raf Grup Farkı - Tam Cam (EMP.NS.70) Top Shelf Group Difference - Full Glass (EMP.NS.70)	1500x440x375			410
EMP.NS.90.USC.T	Üst Raf Grup Farkı - Tam Cam (EMP.NS.90) Top Shelf Group Difference - Full Glass (EMP.NS.90)	1800x440x375			600

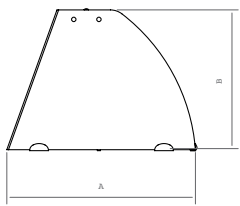

Bombe Cam
Convex Glass

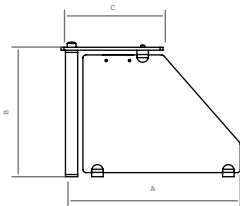

Düz Cam
Flat Glass

Nötr Servis Ünite Aksesuarları
Neutral Service Unit Accessories

Kod Code	Ürün Adı Description	Ebatlar Dimension mm			Fiyatı Price Euro
		a	b	c	
EMP.NS.10.BC.Y	Bombe Cam Farkı - Yarım Cam (EMP.NS.10) Convex Glass Difference - Half Glass (EMP.NS.10)	600x665x440			300
EMP.NS.30.BC.Y	Bombe Cam Farkı - Yarım Cam (EMP.NS.30) Convex Glass Difference - Half Glass (EMP.NS.30)	900x665x440			350
EMP.NS.50.BC.Y	Bombe Cam Farkı - Yarım Cam (EMP.NS.50) Convex Glass Difference - Half Glass (EMP.NS.50)	1150x665x440			380
EMP.NS.70.BC.Y	Bombe Cam Farkı - Yarım Cam (EMP.NS.70) Convex Glass Difference - Half Glass (EMP.NS.70)	1500x665x440			410
EMP.NS.90.BC.Y	Bombe Cam Farkı - Yarım Cam (EMP.NS.90) Convex Glass Difference - Half Glass (EMP.NS.90)	1800x665x440			600



Kod Code	Ürün Adı Description	Ebatlar Dimension mm			Fiyatı Price Euro
		a	b	c	
EMP.NS.10.BC.T	Bombe Cam Farkı - Tam Cam (EMP.NS.10) Convex Glass Difference - Full Glass (EMP.NS.10)	600x665x440			300
EMP.NS.30.BC.T	Bombe Cam Farkı - Tam Cam (EMP.NS.30) Convex Glass Difference - Full Glass (EMP.NS.30)	900x665x440			350
EMP.NS.50.BC.T	Bombe Cam Farkı - Tam Cam (EMP.NS.50) Convex Glass Difference - Full Glass (EMP.NS.50)	1150x665x440			380
EMP.NS.70.BC.T	Bombe Cam Farkı - Tam Cam (EMP.NS.70) Convex Glass Difference - Full Glass (EMP.NS.70)	1500x665x440			410
EMP.NS.90.BC.T	Bombe Cam Farkı - Tam Cam (EMP.NS.90) Convex Glass Difference - Full Glass (EMP.NS.90)	1800x665x440			600



Nötr Servis Ünite Aksesuarları Neutral Service Unit Accessories

Kod Code	Ürün Adı Description	Fiyatı Price Euro
EMP.NS.10.TK	Tepsi Kaydırma Standı Farkı (EMP.NS.10) Tray Sliding Stand Difference (EMP.NS.10)	190
EMP.NS.30.TK	Tepsi Kaydırma Standı Farkı (EMP.NS.30) Tray Sliding Stand Difference (EMP.NS.30)	230
EMP.NS.50.TK	Tepsi Kaydırma Standı Farkı (EMP.NS.50) Tray Sliding Stand Difference (EMP.NS.50)	240
EMP.NS.70.TK	Tepsi Kaydırma Standı Farkı (EMP.NS.70) Tray Sliding Stand Difference (EMP.NS.70)	275
EMP.NS.90.TK	Tepsi Kaydırma Standı Farkı (EMP.NS.90) Tray Sliding Stand Difference (EMP.NS.90)	325



Kod Code	Ürün Adı Description	Fiyatı Price Euro
EMP.NS.10.GT	Granit Tabla Farkı (EMP.NS.10) Granit Table Difference (EMP.NS.10)	300
EMP.NS.30.GT	Granit Tabla Farkı (EMP.NS.30) Granit Table Difference (EMP.NS.30)	325
EMP.NS.50.GT	Granit Tabla Farkı (EMP.NS.50) Granit Table Difference (EMP.NS.50)	450
EMP.NS.70.GT	Granit Tabla Farkı (EMP.NS.70) Granit Table Difference (EMP.NS.70)	525
EMP.NS.90.GT	Granit Tabla Farkı (EMP.NS.90) Granit Table Difference (EMP.NS.90)	625



Köşe Tezgahı ve Küver Ünitesi Corner Service Table and Cutlery Unit



Kod Code	Ürün Adı Description	Ebatlar Dimension mm			Ağırlık Weight kg	Net Net m ³	Fiyatı Price Euro
		a	b	c			
EMP.BKT.10	Köşe Tezgahı Corner Service Table	1400x790x850			75	0.9	750
EMP.BKU.10	Küver Ünitesi Cutlery Unit	800x790x850/1350			75	0.8	665

Türkçe

KÖŞE TEZGAHI VE KÜVER ÜNİTESİ

- Ayarlanabilir ayaklar.
- Opsiyonel ön ahşap giydirme.
- Paslanmaz çelik gövde.

*Standart üretimimizde küvet bulunmamaktadır.

English

CORNER SERVICE TABLE AND CUTLERY UNIT

- Adjustable feet.
- Optional wooden front surface.
- Stainless steel body.

*Standart product does not have containers.

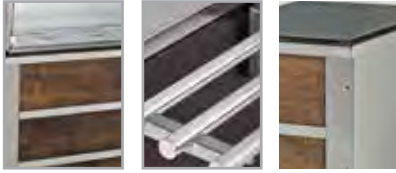

Ahşap Dekor
Wooden Decorated

Tepsi Kaydırma
Standı
Tray Sliding Stand

Granit Tabla
Granit Table



Köşe Tezgahı
Corner Service Table

Küver Ünitesi
Cutlery Unit

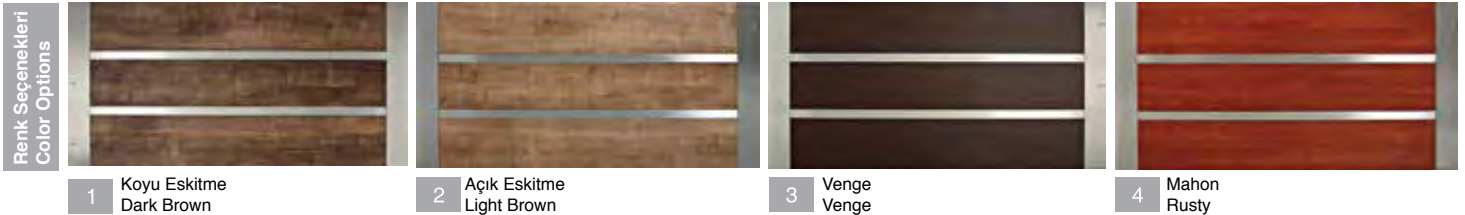

1 Koyu Eskitme
Dark Brown

2 Açık Eskitme
Light Brown

3 Venge
Venge

4 Mahon
Rusty

Köşe Tezgahı ve Küver Ünite Aksesuarları Corner Service Table and Cutlery Unit Accessories

Kod Code	Ürün Adı Description	Fiyatı Price Euro
EMP.BKT.10.AD	Ahşap Dekor Farkı (EMP.BKT.10) Wooden Decorated (EMP.BKT.10)	230
EMP.BKU.10.AD	Ahşap Dekor Farkı (EMP.BKU.10) Wooden Decorated (EMP.BKU.10)	130

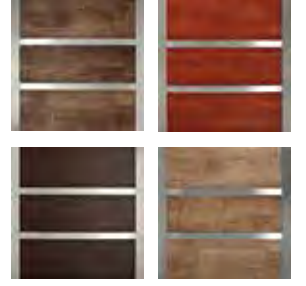

Kod Code	Ürün Adı Description	Fiyatı Price Euro
EMP.BKT.10.TK	Tepsi Kaydırma Standı Farkı (EMP.BKT.10) Tray Sliding Stand Difference (EMP.BKT.10)	300



Kod Code	Ürün Adı Description	Fiyatı Price Euro
EMP.BKT.10.GT	Granit Tabla Farkı (EMP.BKT.10) Granit Table Difference (EMP.BKT.10)	525
EMP.BKU.10.GT	Granit Tabla Farkı (EMP.BKU.10) Granit Table Difference (EMP.BKU.10)	375



EMP.BKT.10+AD+GT



EMP.BKT.10+AD+GT

Merkür Et ve Meze Vitrinleri (Bombe Cam) Mercury Meat and Appetizer Showcases (Convex Glass)



Buğulanma yapmayan ön ısı cam.
Condensation blocker double glazing.

Kod Code	Ürün Adı Description	Ebatlar Dimension mm			Ağırlık Weight kg	Net Net m ³	Motor Gücü Motor Power kw	Elektrik Gücü Electric Power kw	Soğ. Kap Cooling Cap. kw	Fiyatı Price Euro
		a	b	c						
EMP.MZ.100.A.BC	Merkür Et ve Meze Vitrini (Ahşap Dekorlu-Bombe Cam) Mercury Meat and Appetizer Showcase (Wooden Decorated-Convex Glass)	1000	750	1350	240	1.1	0.5	0.7	1.01	2.650
EMP.MZ.100.P.BC	Merkür Et ve Meze Vitrini (Paslanmaz Çelik-Bombe Cam) Mercury Meat and Appetizer Showcase (Stainless Steel-Convex Glass)	1000	750	1350	240	1.1	0.5	0.7	1.01	2.900
EMP.MZ.150.A.BC	Merkür Et ve Meze Vitrini (Ahşap Dekorlu-Bombe Cam) Mercury Meat and Appetizer Showcase (Wooden Decorated-Convex Glass)	1500	750	1350	296	1.4	0.5	0.8	1.08	3.150
EMP.MZ.150.P.BC	Merkür Et ve Meze Vitrini (Paslanmaz Çelik-Bombe Cam) Mercury Meat and Appetizer Showcase (Stainless Steel-Convex Glass)	1500	750	1350	296	1.4	0.5	0.8	1.08	3.450
EMP.MZ.200.A.BC	Merkür Et ve Meze Vitrini (Ahşap Dekorlu-Bombe Cam) Mercury Meat and Appetizer Showcase (Wooden Decorated-Convex Glass)	2000	750	1350	350	1.9	0.5+	0.98	1.73	3.700
EMP.MZ.200.P.BC	Merkür Et ve Meze Vitrini (Paslanmaz Çelik-Bombe Cam) Mercury Meat and Appetizer Showcase (Stainless Steel-Convex Glass)	2000	750	1350	350	1.9	0.5+	0.98	1.73	4.000

Türkçe

MERKÜR ET ve MEZE VİTRİNLERİ (BOMBE CAM)

- Çalışma aralığı; +0° C, + 8° C (tropikal 43° C)
- İçten motorlu soğutma uygulaması.
- Reyon altı depolama sistemi.
- Bombe camlı meze vitrinlerinde açılabilir ön cam.
- Statik soğutma.
- R-134 A soğutucu gaz.
- Led aydınlatma sistemi.
- 40 kg/m³ yoğunluk poliüretan izolasyon.
- Opsiyonel ahşap gövde.

English

MERCURY MEAT AND APPETIZER SHOWCASES (CONVEX GLASS)

- Working temperature; 0° C, + 8° C (at ambient temp. 43° C)
- Interior engined refrigerating system.
- Under-set storage system.
- Lift up safety front glass, for convex glass showcase.
- Static cooling.
- R-134 A refrigerant gas.
- Led lighting system.
- 40 kg/m³ density polyurathane isolation.
- Optional wooden body colour.

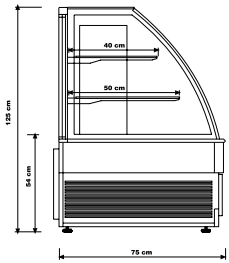

Renk Seçenekleri
Color Options



1 Koyu Eskitme
Dark Brown



2 Açık Eskitme
Light Brown



3 Venge
Venge



4 Mahon
Rusty

Merkür Et ve Meze Vitrinleri (Düz Cam) Mercury Meat and Appetizer Showcases (Flat Glass)



Buğulanma yapmayan ön ısı cam.
Condensation blocker double glazing.

Kod Code	Ürün Adı Description	Ebatlar Dimension mm			Ağırlık Weight kg	Net Net m³	Motor Gücü Motor Power kw	Elektrik Gücü Electric Power kw	Soğ. Kap Cooling Cap. kw	Fiyatı Price Euro
		a	b	c						
EMP.MZ.100.A.DC	Merkür Et ve Meze Vitrini (Ahşap Dekorlu-Düz Cam) Mercury Meat and Appetizer Showcase (Wooden Decorated-Flat Glass)	1000	750	1350	240	1.1	0.5	0.7	1.01	2.650
EMP.MZ.100.P.DC	Merkür Et ve Meze Vitrini (Paslanmaz Çelik-Düz Cam) Mercury Meat and Appetizer Showcase (Stainless Steel-Flat Glass)	1000	750	1350	240	1.1	0.5	0.7	1.01	2.900
EMP.MZ.150.A.DC	Merkür Et ve Meze Vitrini (Ahşap Dekorlu-Düz Cam) Mercury Meat and Appetizer Showcase (Wooden Decorated-Flat Glass)	1500	750	1350	296	1.4	0.5	0.8	1.08	3.150
EMP.MZ.150.P.DC	Merkür Et ve Meze Vitrini (Paslanmaz Çelik-Düz Cam) Mercury Meat and Appetizer Showcase (Stainless Steel-Flat Glass)	1500	750	1350	296	1.4	0.5	0.8	1.08	3.450
EMP.MZ.200.A.DC	Et ve Meze Vitrini (Ahşap Dekorlu-Düz Cam) Mercury Meat and Appetizer Showcase (Wooden Decorated-Flat Glass)	2000	750	1350	350	1.9	0.5+	0.98	1.73	3.700
EMP.MZ.200.P.DC	Merkür Et ve Meze Vitrini (Paslanmaz Çelik-Düz Cam) Mercury Meat and Appetizer Showcase (Stainless Steel-Flat Glass)	2000	750	1350	350	1.9	0.5+	0.98	1.73	4.000

Türkçe

MERKÜR ET ve MEZE VİTRİNLERİ (DÜZ CAM)

- Çalışma aralığı: +0° C, + 8° C (tropikal 43° C)
- İçten motorlu soğutma uygulaması.
- Reyon altı depolama sistemi.
- Statik soğutma.
- R-134 A soğutucu gaz.
- Led aydınlatma sistemi.
- 40 kg/m3 yoğunluk poliüretan izolasyon.
- Opsiyonel ahşap gövde.

English

MERCURY MEAT AND APPETIZER SHOWCASES (FLAT GLASS)

- Working temperature; 0° C, + 8° C
(at ambient temp. 43° C)
- Interior engined refrigerating system.
- Under-set storage system.
- Static cooling.
- R-134 A refrigerant gas.
- Led lighting system.
- 40 kg/m3 density polyurathane isolation.
- Optional wooden body colour.



Renk Seçenekleri
Color Options

1 Koyu Eskitme
Dark Brown

2 Açık Eskitme
Light Brown

3 Venge
Venge

4 Mahon
Rusty

Plüton Et ve Meze Teşhir Vitrinleri (Düz Camlı)
Pluton Meat and Apettizer Showcase (Flat Glass)



Buğulanma yapmayan ön ısı cam.
Condensation blocker double glazing.

Kod Code	Ürün Adı Description	Ebatlar Dimension mm			Ağırlık Weight kg	Net Net m³	Motor Gücü Motor Power kw	Elektrik Gücü Electric Power kw	Soğ. Kap Cooling Cap. kw	Fiyatı Price Euro
		a	b	c						
EMP.VT.D.100.S	Plüton Et ve Meze Teşhir Vitrinleri (Düz Camlı) Pluton Meat and Apettizer Showcase (Flat Glass)	1000	870	1350	172	1.1	0.5	0.98	1.73	2.750
EMP.VT.D.130.S	Plüton Et ve Meze Teşhir Vitrinleri (Düz Camlı) Pluton Meat and Apettizer Showcase (Flat Glass)	1300	870	1350	224	1.2	0.5	0.98	1.73	3.100
EMP.VT.D.160.S	Plüton Et ve Meze Teşhir Vitrinleri (Düz Camlı) Pluton Meat and Apettizer Showcase (Flat Glass)	1600	870	1350	255	1.5	0.5	0.98	1.73	3.300
EMP.VT.D.200.S	Plüton Et ve Meze Teşhir Vitrinleri (Düz Camlı) Pluton Meat and Apettizer Showcase (Flat Glass)	2000	870	1350	276	1.5	0.5	1.01	2.07	3.850

Türkçe

**PLÜTON ET ve MEZE TEŞHİR VİTRİNLERİ
(DÜZ CAMLI)**

- Çalışma aralığı; +0° C, + 8° C (tropikal 43° C)
- İçten motorlu soğutma uygulaması.
- Reyon altı depolama sistemi.
- Fanlı soğutma.
- R-134 A soğutucu gaz.
- Led aydınlatma sistemi.
- 40 kg/m3 yoğunluk poliüretan izolasyon.
- Opsiyonel ahşap gövde.

English

PLUTON MEAT AND APETTIZER SHOWCASE (FLAT GLASS)

- Working temperature; 0° C, + 8° C
(at ambient temp. 43° C)
- Interior engined refrigeration system.
- Under-set storage system.
- Cooling with fan.
- Refrigerant gas:R-134 A
- Led lighting system.
- 40 kg/m3 density polyurathane isolation.
- Optional wooden body colour.



Renk Seçenekleri
Color Options

1 Koyu Eskitme
Dark Brown

2 Açık Eskitme
Light Brown

3 Venge
Venge

4 Mahon
Rusty

Plüton Et ve Meze Teşhir Vitrinleri (Bombe Camlı) Pluton Meat and Apettizer Showcase (Convex Glass)



Buğulanma yapmayan ön ısı cam.
Condensation blocker double glazing.

Kod Code	Ürün Adı Description	Ebatlar Dimension mm			Ağırlık Weight kg	Net Net m ³	Motor Gücü Motor Power kw	Elektrik Gücü Electric Power kw	Soğ. Kap Cooling Cap. kw	Fiyatı Price Euro
		a	b	c						
EMP.VT.B.100.S	Plüton Et ve Meze Teşhir Vitrinleri (Bombe Camlı) Pluton Meat and Apettizer Showcase (Convex Glass)	1000	870	1350	172	1.1	0.5	0.98	1.73	2.750
EMP.VT.B.130.S	Plüton Et ve Meze Teşhir Vitrinleri (Bombe Camlı) Pluton Meat and Apettizer Showcase (Convex Glass)	1300	870	1350	224	1.2	0.5	0.98	1.73	3.100
EMP.VT.B.160.S	Plüton Et ve Meze Teşhir Vitrinleri (Bombe Camlı) Pluton Meat and Apettizer Showcase (Convex Glass)	1600	870	1350	255	1.5	0.5	0.98	1.73	3.300
EMP.VT.B.200.S	Plüton Et ve Meze Teşhir Vitrinleri (Bombe Camlı) Pluton Meat and Apettizer Showcase (Convex Glass)	2000	870	1350	276	1.5	0.5	1.01	2.07	3.850

Türkçe

PLÜTON ET VE MEZE TEŞHİR VİTRİNLERİ (BOMBE CAMLI)

- Çalışma aralığı: +0° C, + 8° C (tropikal 43° C)
- İçten motorlu soğutma uygulaması.
- Reyon altı depolama sistemi.
- Açılabilir ön cam.
- Fanlı soğutma.
- R-134 A soğutucu gaz.
- Led aydınlatma sistemi.
- 40 kg/m3 yoğunluk poliüretan izolasyon.
- Opsiyonel ahşap gövde.

English

PLUTON MEAT AND APETTIZER SHOWCASE (CONVEX GLASS)

- Working temperature; 0° C, + 8° C (at ambient temp. 43° C)
- Interior engined refrigeration system.
- Under-set storage system.
- Lift up safety front glass.
- Cooling with fan.
- Refrigerant gas:R-134 A
- Led lighting system.
- 40 kg/m3 density polyurathane isolation.
- Optional wooden body colour.



Renk Seçenekleri
Color Options



1 Koyu Eskitme
Dark Brown



2 Açık Eskitme
Light Brown



3 Venge
Venge



4 Mahon
Rusty



Venüs Pasta Vitrinleri Venus Pastry Showcase



Buğulanma yapmayan ön ısı cam.
Condensation blocker double glazing.

Kod Code	Ürün Adı Description	Ebatlar Dimension mm			Ağırlık Weight kg	Net Net m³	Motor Gücü Motor Power kw	Elektrik Gücü Electric Power kw	Soğ. Kap Cooling Cap. kw	Fiyatı Price Euro
		a	b	c						
EMP.BC.100.S	Venüs Pasta Vitrini (Soğutmalı) Venus Pastry Showcase (Cooling)	1000	750	1350	172	1.01	0.5	0.7	1.15	2.600
EMP.BC.100.N	Venüs Pasta Vitrini (Nötr) Venus Pastry Showcase (Neutral)	1000	750	1350	158	1.01				2.200
EMP.BC.100.I	Venüs Pasta Vitrini (Isıtmalı) Venus Pastry Showcase (Heating)	1000	750	1350	165	1.01		0.7		2.400
EMP.BC.130.S	Venüs Pasta Vitrini (Soğutmalı) Venus Pastry Showcase (Cooling)	1300	750	1350	224	1.2	0.5	0.98	1.73	2.900
EMP.BC.130.N	Venüs Pasta Vitrini (Nötr) Venus Pastry Showcase (Neutral)	1300	750	1350	204	1.2				2.450
EMP.BC.130.I	Venüs Pasta Vitrini (Isıtmalı) Venus Pastry Showcase (Heating)	1300	750	1350	210	1.2		0.98		2.700
EMP.BC.160.S	Venüs Pasta Vitrini (Soğutmalı) Venus Pastry Showcase (Cooling)	1600	750	1350	276	1.5	0.5	0.98	1.73	3.300
EMP.BC.160.N	Venüs Pasta Vitrini (Nötr) Venus Pastry Showcase (Neutral)	1600	750	1350	250	1.5				2.600
EMP.BC.160.I	Venüs Pasta Vitrini (Isıtmalı) Venus Pastry Showcase (Heating)	1600	750	1350	255	1.5		0.98		2.800
EMP.BC.200.S	Venüs Pasta Vitrini (Soğutmalı) Venus Pastry Showcase (Cooling)	2000	750	1350	330	1.9	0.75	1.01	2.07	3.700
EMP.BC.200.N	Venüs Pasta Vitrini (Nötr) Venus Pastry Showcase (Neutral)	2000	750	1350	300	1.9				2.900
EMP.BC.200.I	Venüs Pasta Vitrini (Isıtmalı) Venus Pastry Showcase (Heating)	2000	750	1350	305	1.9		1.01		3.200



Türkçe

VENÜS PASTA VİTRİNLERİ

- Çalışma aralığı: +0° C, +8° C (tropikal 43° C)
- İçten motorlu soğutma uygulaması.
- Reyon altı depolama sistemi.
- Açılabilir ön cam.
- Fanlı soğutma.
- R-134 A soğutucu gaz.
- Led aydınlatma sistemi.
- 40 kg/m3 yoğunluk poliüretan izolasyon.
- Opsiyonel ahşap gövde.

English

VENUS PASTRY SHOWCASE

- Working temperature; 0° C, +8° C (at ambient temp. 43° C)
- Interior engined refrigeration system
- Under-set storage system.
- Lift up safety front glass.
- Cooling with fan.
- Refrigerant gas:R-134 A
- Led lighting system.
- 40 kg/m3 density polyurathane isolation.
- Optional wooden body colour.

Renk Seçenekleri
Color Options



1 Koyu EskiTme
Dark Brown



2 Açık EskiTme
Light Brown



3 Venge
Venge



4 Mahon
Rusty

Neptün Pasta Vitrinleri Neptun Pastry Showcase



Buğulanma yapmayan ön ısı cam.
Condensation blocker double glazing.

Kod Code	Ürün Adı Description	Ebatlar Dimension mm			Ağırlık Weight kg	Net Net m ³	Motor Gücü Motor Power kw	Elektrik Gücü Electric Power kw	Soğ. Kap Cooling Cap. kw	Fiyatı Price Euro
		a	b	c						
EMP.DT.100.S	Neptün Pasta Vitrini (Soğutmalı) Neptun Pastry Showcase (Cooling)	1000x750x1350			172	1.01	0.5	0.7	1.15	2.600
EMP.DT.100.N	Neptün Pasta Vitrini (Nötr) Neptun Pastry Showcase (Neutral)	1000x750x1350			158	1.01				2.200
EMP.DT.100.I	Neptün Pasta Vitrini (Isıtılmalı) Neptun Pastry Showcase (Heating)	1000x750x1350			165	1.01		0.7		2.400
EMP.DT.130.S	Neptün Pasta Vitrini (Soğutmalı) Neptun Pastry Showcase (Cooling)	1300x750x1350			224	1.2	0.5	0.98	1.73	2.900
EMP.DT.130.N	Neptün Pasta Vitrini (Nötr) Neptun Pastry Showcase (Neutral)	1300x750x1350			204	1.2				2.450
EMP.DT.130.I	Neptün Pasta Vitrini (Isıtılmalı) Neptun Pastry Showcase (Heating)	1300x750x1350			210	1.2		0.98		2.700
EMP.DT.160.S	Neptün Pasta Vitrini (Soğutmalı) Neptun Pastry Showcase (Cooling)	1600x750x1350			276	1.5	0.5	0.98	1.73	3.300
EMP.DT.160.N	Neptün Pasta Vitrini (Nötr) Neptun Pastry Showcase (Neutral)	1600x750x1350			250	1.5				2.600
EMP.DT.160.I	Neptün Pasta Vitrini (Isıtılmalı) Neptun Pastry Showcase (Heating)	1600x750x1350			255	1.5		0.98		2.800
EMP.DT.200.S	Neptün Pasta Vitrini (Soğutmalı) Neptun Pastry Showcase (Cooling)	2000x750x1350			330	1.9	0.75	1.01	2.07	3.700
EMP.DT.200.N	Neptün Pasta Vitrini (Nötr) Neptun Pastry Showcase (Neutral)	2000x750x1350			300	1.9				2.900
EMP.DT.200.I	Neptün Pasta Vitrini (Isıtılmalı) Neptun Pastry Showcase (Heating)	2000x750x1350			305	1.9		1.01		3.200

Türkçe

NEPTÜN PASTA VİTRİNLERİ

- Çalışma aralığı; +0° C, + 8° C (tropikal 43° C)
- İçten motorlu soğutma uygulaması.
- Reyon altı depolama sistemi.
- Fanlı soğutma.
- R-134 A soğutucu gaz.
- Led aydınlatma sistemi.
- 40 kg/m3 yoğunluk poliüretan izolasyon.
- Opsiyonel ahşap gövde.

English

NEPTUN PASTRY SHOWCASE

- Working temperature; 0° C, + 8° C (at ambient temp. 43° C)
- Interior engine refrigeration system.
- Bottom storage cabinet.
- Cooling with fan.
- Refrigerant gas:R-134 A
- Led lighting system.
- 40 kg/m3 density polyurethane isolation.
- Optional wooden body colour.

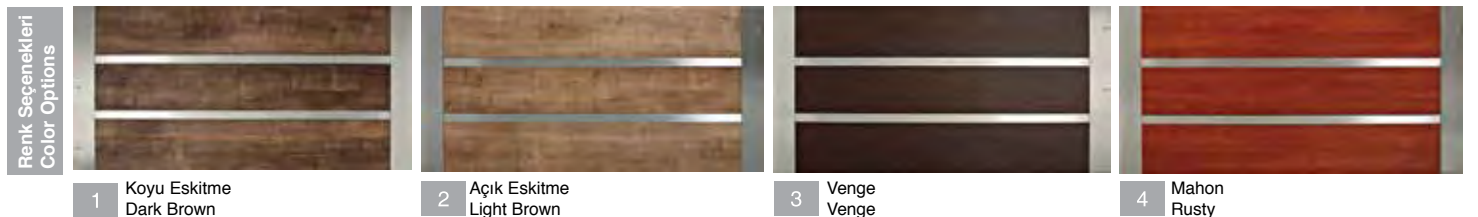



G|R|O|U|P

empero@empero.com.tr

Servis Üniteleri
Service Units



empero@empero.com.tr



Almila Nötr Servis Ünitesi / Almila Nötr Service Units

Almila Nötr Servis Ünitesi Nefeslikli / Almila Nötr Service Units

Almila Soğuk Servis Ünitesi Nefeslikli / Almila Cold Service Unit

Almila Paslanmaz Soğuk Servis Ünitesi Nefeslikli / Almila S/S Cold Service Units

Almila Sıcak Servis Ünitesi (Benmari - Nefeslikli) / Almila Hot Service Units (Bainmarie)

Almila Sıcak Servis Ünitesi Nefeslikli / Almila Hot Service Units Chafing Dish

Almila Sıcak Servis Ünitesi / Almila Hot Service Units Chafing Dish

Almila Çorba Servis Ünitesi / Almila Soup Service Units

Almila Ekmek Servis Ünitesi / Almila Bread Service Units

Almila U Form Tabaklık / Almila Plate Dispenser Unit

Almila Tabak Dispenseri / Almila Plate Dispenser

Almila Nötr Servis Ünitesi

Almila Nötr Service Units



Kod Code	Ebatlar Dimension mm	Fiyatı Price Euro
ALM.NTR.01	1000 x 900 x 900	1.740
ALM.NTR.02	1200 x 900 x 900	1.945
ALM.NTR.03	1400 x 900 x 900	2.150
ALM.NTR.04	1600 x 900 x 900	2.355
ALM.NTR.05	1800 x 900 x 900	2.560
ALM.NTR.06	2000 x 900 x 900	2.770
ALM.NTR.07	2200 x 900 x 900	2.980
ALM.NTR.08	2400 x 900 x 900	3.180

Almila Nötr Servis Ünitesi Nefeslikli

Almila Nötr Service Units



Kod Code	Ebatlar Dimension mm	Fiyatı Price Euro
ALM.NTR-N.01	1000 x 900 x 900 / 1550	1.955
ALM.NTR-N.02	1200 x 900 x 900 / 1550	2.190
ALM.NTR-N.03	1400 x 900 x 900 / 1550	2.410
ALM.NTR-N.04	1600 x 900 x 900 / 1550	2.635
ALM.NTR-N.05	1800 x 900 x 900 / 1550	2.865
ALM.NTR-N.06	2000 x 900 x 900 / 1550	3.090
ALM.NTR-N.07	2200 x 900 x 900 / 1550	3.315
ALM.NTR-N.08	2400 x 900 x 900 / 1550	3.540

Almila Soğuk Servis Ünitesi Nefeslikli

Almila Cold Service Unit



Kod Code	Ebatlar Dimension mm	Fiyatı Price Euro
ALM.SSU-N.01	1000 x 900 x 900 / 1550	3.220
ALM.SSU-N.02	1200 x 900 x 900 / 1550	3.400
ALM.SSU-N.03	1400 x 900 x 900 / 1550	3.600
ALM.SSU-N.04	1600 x 900 x 900 / 1550	4.100
ALM.SSU-N.05	1800 x 900 x 900 / 1550	4.310
ALM.SSU-N.06	2000 x 900 x 900 / 1550	4.515
ALM.SSU-N.07	2200 x 900 x 900 / 1550	4.860
ALM.SSU-N.08	2400 x 900 x 900 / 1550	5.095

Almila Paslanmaz Soğuk Servis Ünitesi Nefeslikli

Almila S/S Cold Service Units



Kod Code	Ebatlar Dimension mm	Fiyatı Price Euro
ALM.P.SSU.01	1000 x 900 x 900 / 1550	3.320
ALM.P.SSU.02	1200 x 900 x 900 / 1550	3.500
ALM.P.SSU.03	1400 x 900 x 900 / 1550	3.720
ALM.P.SSU.04	1600 x 900 x 900 / 1550	4.230
ALM.P.SSU.05	1800 x 900 x 900 / 1550	4.445
ALM.P.SSU.06	2000 x 900 x 900 / 1550	4.655
ALM.P.SSU.07	2200 x 900 x 900 / 1550	4.870
ALM.P.SSU.08	2400 x 900 x 900 / 1550	5.255

Almila Sıcak Servis Ünitesi (Benmari - Nefeslikli)

Almila Hot Service Units (Bainmarie)



Kod Code	Ebatlar Dimension mm	Kapasite Capacity	Fiyatı Price Euro
ALM.SSB.01	1200 x 900 x 900 / 1550	2 x 1/1 GN	2.570
ALM.SSB.02	1600 x 900 x 900 / 1550	3 x 1/1 GN	3.405
ALM.SSB.03	2000 x 900 x 900 / 1550	4 x 1/1 GN	4.225
ALM.SSB.04	2400 x 900 x 900 / 1550	5 x 1/1 GN	5.055

Almila Sıcak Servis Ünitesi Nefeslikli

Almila Hot Service Units Chafing Dish



Kod Code	Ebatlar Dimension mm	Kapasite Capacity	Fiyatı Price Euro
ALM.SSC-N.01	1200 x 900 x 900 / 1550	1 Chafing Dish	3.140
ALM.SSC-N.02	1800 x 900 x 900 / 1550	2 Chafing Dish	4.625
ALM.SSC-N.03	2400 x 900 x 900 / 1550	3 Chafing Dish	6.090

Almila Sıcak Servis Ünitesi

Almila Hot Service Units Chafing Dish



Kod Code	Ebatlar Dimension mm	Kapasite Capacity	Fiyatı Price Euro
ALM.SSC.01	1200 x 900 x 900 / 1550	1 Chafing Dish	2.915
ALM.SSC.02	1800 x 900 x 900 / 1550	2 Chafing Dish	4.325
ALM.SSC.03	2400 x 900 x 900 / 1550	3 Chafing Dish	5.730

Almila Çorba Servis Ünitesi

Almila Soup Service Units



Kod Code	Ebatlar Dimension mm	Kapasite Capacity	Fiyatı Price Euro
ALM.CSU.01	1400 x 900 x 900	1 Çorbalık / Soup Dispenser	3.215
ALM.CSU.02	2000 x 900 x 900	2 Çorbalık / Soup Dispenser	4.680
ALM.CSU.03	2400 x 900 x 900	3 Çorbalık / Soup Dispenser	5.095

Almila Ekmek Servis Ünitesi

Almila Bread Service Units



Kod Code	Ebatlar Dimension mm	Fiyatı Price Euro
ALM.ESU.01	1000 x 900 x 900 / 1550	2.390
ALM.ESU.02	1200 x 900 x 900 / 1550	2.570
ALM.ESU.03	1400 x 900 x 900 / 1550	2.800
ALM.ESU.04	1600 x 900 x 900 / 1550	2.980
ALM.ESU.05	1800 x 900 x 900 / 1550	3.190
ALM.ESU.06	2000 x 900 x 900 / 1550	3.395
ALM.ESU.07	2200 x 900 x 900 / 1550	3.600
ALM.ESU.08	2400 x 900 x 900 / 1550	3.580

Almila U Form Tabaklık

Almila Plate Dispenser Unit



Kod Code	Ebatlar Dimension mm	Fiyatı Price Euro
ALM.UT.01	1100 x 900 x 900	2.000

Almila Tabak Dispenseri
Almila Plate Dispenser

Kod Code	Ebatlar Dimension mm	Kapasite Capacity	Fiyatı Price Euro
ALM.TD.01	1100 x 900 x 900	2 Tabaklı / Plate Isıtmalı / Heated	2.700
ALM.TD.02	1100 x 900 x 900	2 Tabaklı / Plate Nötr / Neutral	2.200





Magrex Nötr Servis Ünitesi / Magrex Nötr Service Units

Magrex Nötr Servis Ünitesi Nefeslikli / Magrex Nötr Service Units

Magrex Soğuk Servis Ünitesi Nefeslikli / Magrex Cold Service Unit

Magrex Paslanmaz Soğuk Servis Ünitesi Nefeslikli / Magrex S/S Cold Service Units

Magrex Sıcak Servis Ünitesi (Benmari - Nefeslikli) / Magrex Hot Service Units (Bainmarie)

Magrex Sıcak Servis Ünitesi Nefeslikli / Magrex Hot Service Units Chafing Dish

Magrex Sıcak Servis Ünitesi / Magrex Hot Service Units Chafing Dish

Magrex Çorba Servis Ünitesi / Magrex Soup Service Units

Magrex Ekmek Servis Ünitesi / Magrex Bread Service Units

Magrex U Form Tabaklık / Magrex Plate Dispenser Unit

Magrex Tabak Dispenseri / Magrex Plate Dispenser

Magrex Nötr Servis Ünitesi

Magrex Nötr Service Units



Kod Code	Ebatlar Dimension mm	Fiyatı Price Euro
MGR.NTR.01	1000 x 900 x 900	1.735
MGR.NTR.02	1200 x 900 x 900	1.945
MGR.NTR.03	1400 x 900 x 900	2.150
MGR.NTR.04	1600 x 900 x 900	2.355
MGR.NTR.05	1800 x 900 x 900	2.565
MGR.NTR.06	2000 x 900 x 900	2.770
MGR.NTR.07	2200 x 900 x 900	2.980
MGR.NTR.08	2400 x 900 x 900	3.180

Magrex Nötr Servis Ünitesi Nefeslikli

Magrex Nötr Service Units



Kod Code	Ebatlar Dimension mm	Fiyatı Price Euro
MGR.NTR-N.01	1000 x 900 x 900 / 1550	1.955
MGR.NTR-N.02	1200 x 900 x 900 / 1550	1.985
MGR.NTR-N.03	1400 x 900 x 900 / 1550	2.410
MGR.NTR-N.04	1600 x 900 x 900 / 1550	2.635
MGR.NTR-N.05	1800 x 900 x 900 / 1550	2.865
MGR.NTR-N.06	2000 x 900 x 900 / 1550	3.090
MGR.NTR-N.07	2200 x 900 x 900 / 1550	3.315
MGR.NTR-N.08	2400 x 900 x 900 / 1550	3.540

Magrex Soğuk Servis Ünitesi Nefeslikli

Magrex Cold Service Unit



Kod Code	Ebatlar Dimension mm	Fiyatı Price Euro
MGR.SSU-N.01	1000 x 900 x 900 / 1550	3.220
MGR.SSU-N.02	1200 x 900 x 900 / 1550	3.400
MGR.SSU-N.03	1400 x 900 x 900 / 1550	3.600
MGR.SSU-N.04	1600 x 900 x 900 / 1550	4.100
MGR.SSU-N.05	1800 x 900 x 900 / 1550	4.310
MGR.SSU-N.06	2000 x 900 x 900 / 1550	4.515
MGR.SSU-N.07	2200 x 900 x 900 / 1550	4.820
MGR.SSU-N.08	2400 x 900 x 900 / 1550	5.095

Magrex Paslanmaz Soğuk Servis Ünitesi Nefeslikli

Magrex S/S Cold Service Units



Kod Code	Ebatlar Dimension mm	Fiyatı Price Euro
MGR.P.SSU.01	1000 x 900 x 900 / 1550	2.965
MGR.P.SSU.02	1200 x 900 x 900 / 1550	3.170
MGR.P.SSU.03	1400 x 900 x 900 / 1550	3.380
MGR.P.SSU.04	1600 x 900 x 900 / 1550	4.395
MGR.P.SSU.05	1800 x 900 x 900 / 1550	4.600
MGR.P.SSU.06	2000 x 900 x 900 / 1550	4.800
MGR.P.SSU.07	2200 x 900 x 900 / 1550	5.825

Magrex Sıcak Servis Ünitesi (Benmari - Nefeslikli)

Magrex Hot Service Units (Bainmarie)



Kod Code	Ebatlar Dimension mm	Kapasite Capacity	Fiyatı Price Euro
MGR.SSB.01	1200 x 900 x 900 / 1550	2 x 1/1 GN	2.570
MGR.SSB.02	1600 x 900 x 900 / 1550	3 x 1/1 GN	3.400
MGR.SSB.03	2000 x 900 x 900 / 1550	4 x 1/1 GN	4.225
MGR.SSB.04	2400 x 900 x 900 / 1550	5 x 1/1 GN	5.055

Magrex Sıcak Servis Ünitesi Nefeslikli

Magrex Hot Service Units Chafing Dish



Kod Code	Ebatlar Dimension mm	Kapasite Capacity	Fiyatı Price Euro
MGR.SSC-N.01	1200 x 900 x 900 / 1550	1 Chafing Dish	3.135
MGR.SSC-N.02	1800 x 900 x 900 / 1550	2 Chafing Dish	4.625
MGR.SSC-N.03	2400 x 900 x 900 / 1550	3 Chafing Dish	6.085

Magrex Sıcak Servis Ünitesi

Magrex Hot Service Units Chafing Dish



Kod Code	Ebatlar Dimension mm	Kapasite Capacity	Fiyatı Price Euro
MGR.SSC.01	1200 x 900 x 900 / 1550	1 Chafing Dish	2.915
MGR.SSC.02	1800 x 900 x 900 / 1550	2 Chafing Dish	4.325
MGR.SSC.03	2400 x 900 x 900 / 1550	3 Chafing Dish	5.730

Magrex Çorba Servis Ünitesi

Magrex Soup Service Units



Kod Code	Ebatlar Dimension mm	Kapasite Capacity	Fiyatı Price Euro
MGR.CSU.01	1400 x 900 x 900	1 Çorbalık / Soup Dispenser	3.215
MGR.CSU.02	2000 x 900 x 900	2 Çorbalık / Soup Dispenser	4.680
MGR.CSU.03	2400 x 900 x 900	3 Çorbalık / Soup Dispenser	5.095

Magrex Ekmek Servis Ünitesi
Magrex Bread Service Units

Kod Code	Ebatlar Dimension mm	Fiyatı Price Euro
MGR.ESU.01	1000 x 900 x 900 / 1550	2.390
MGR.ESU.02	1200 x 900 x 900 / 1550	2.570
MGR.ESU.03	1400 x 900 x 900 / 1550	2.800
MGR.ESU.04	1600 x 900 x 900 / 1550	2.980
MGR.ESU.05	1800 x 900 x 900 / 1550	3.190
MGR.ESU.06	2000 x 900 x 900 / 1550	3.395
MGR.ESU.07	2200 x 900 x 900 / 1550	3.600
MGR.ESU.08	2400 x 900 x 900 / 1550	3.580

Magrex U Form Tabaklık
Magrex Plate Dispenser Unit

Kod Code	Ebatlar Dimension mm	Fiyatı Price Euro
MGR.UT.01	1100 x 900 x 900	2.000

Magrex Tabak Dispenseri
Magrex Plate Dispenser



Kod Code	Ebatlar Dimension mm	Kapasite Capacity	Fiyatı Price Euro
MGR.TD.01	1100 x 900 x 900	2 Tabaklı / Plate Isıtmalı / Heated	2.700
MGR.TD.02	1100 x 900 x 900	2 Tabaklı / Plate Nötr / Neutral	2.200





Dolce Nötr Servis Ünitesi / Dolce Nötr Service Units

Dolce Nötr Servis Ünitesi Nefeslikli / Dolce Nötr Service Units

Dolce Soğuk Servis Ünitesi Nefeslikli / Dolce Cold Service Unit

Dolce Paslanmaz Soğuk Servis Ünitesi Nefeslikli / Dolce S/S Cold Service Units

Dolce Sıcak Servis Ünitesi (Benmari - Nefeslikli) / Dolce Hot Service Units (Bainmarie)

Dolce Sıcak Servis Ünitesi Nefeslikli / Dolce Hot Service Units Chafing Dish

Dolce Sıcak Servis Ünitesi / Dolce Hot Service Units Chafing Dish

Dolce Çorba Servis Ünitesi / Dolce Soup Service Units

Dolce Ekmek Servis Ünitesi / Dolce Bread Service Units

Dolce U Form Tabaklık / Dolce Plate Dispenser Unit

Dolce Tabak Dispenseri / Dolce Plate Dispenser

Dolce Nötr Servis Ünitesi

Dolce Nötr Service Units



Kod Code	Ebatlar Dimension mm	Fiyatı Price Euro
DLC.NTR.01	1000 x 900 x 900	2.030
DLC.NTR.02	1200 x 900 x 900	2.235
DLC.NTR.03	1400 x 900 x 900	2.475
DLC.NTR.04	1600 x 900 x 900	2.700
DLC.NTR.05	1800 x 900 x 900	2.945
DLC.NTR.06	2000 x 900 x 900	3.185
DLC.NTR.07	2200 x 900 x 900	3.420
DLC.NTR.08	2400 x 900 x 900	3.655

Dolce Nötr Servis Ünitesi Nefeslikli

Dolce Nötr Service Units



Kod Code	Ebatlar Dimension mm	Fiyatı Price Euro
DLC.NTR-N.01	1000 x 900 x 900 / 1550	2.250
DLC.NTR-N.02	1200 x 900 x 900 / 1550	2.750
DLC.NTR-N.03	1400 x 900 x 900 / 1550	2.870
DLC.NTR-N.04	1600 x 900 x 900 / 1550	2.985
DLC.NTR-N.05	1800 x 900 x 900 / 1550	2.345
DLC.NTR-N.06	2000 x 900 x 900 / 1550	3.505
DLC.NTR-N.07	2200 x 900 x 900 / 1550	3.760
DLC.NTR-N.08	2400 x 900 x 900 / 1550	4.020

Dolce Soğuk Servis Ünitesi Nefeslikli
Dolce Cold Service Units



Kod Code	Ebatlar Dimension mm	Fiyatı Price Euro
DLC.SSU-N.01	1000 x 900 x 900 / 1550	3.700
DLC.SSU-N.02	1200 x 900 x 900 / 1550	3.910
DLC.SSU-N.03	1400 x 900 x 900 / 1550	4.145
DLC.SSU-N.04	1600 x 900 x 900 / 1550	4.715
DLC.SSU-N.05	1800 x 900 x 900 / 1550	4.955
DLC.SSU-N.06	2000 x 900 x 900 / 1550	5.190
DLC.SSU-N.07	2200 x 900 x 900 / 1550	5.430
DLC.SSU-N.08	2400 x 900 x 900 / 1550	5.855

Dolce Paslanmaz Soğuk Servis Ünitesi Nefeslikli
Dolce S/S Cold Service Units



Kod Code	Ebatlar Dimension mm	Fiyatı Price Euro
DLC.P.SSU.01	1000 x 900 x 900 / 1550	3.820
DLC.P.SSU.02	1200 x 900 x 900 / 1550	4.035
DLC.P.SSU.03	1400 x 900 x 900 / 1550	4.275
DLC.P.SSU.04	1600 x 900 x 900 / 1550	4.865
DLC.P.SSU.05	1800 x 900 x 900 / 1550	5.115
DLC.P.SSU.06	2000 x 900 x 900 / 1550	5.355
DLC.P.SSU.07	2200 x 900 x 900 / 1550	5.600
DLC.P.SSU.08	2400 x 900 x 900 / 1550	6.040

Dolce Sıcak Servis Ünitesi (Benmari - Nefeslikli)

Dolce Hot Service Units (Bainmarie)



Kod Code	Ebatlar Dimension mm	Kapasite Capacity	Fiyatı Price Euro
DLC.SSB.01	1200 x 900 x 900 / 1550	2 x 1/1 GN	2.955
DLC.SSB.02	1600 x 900 x 900 / 1550	3 x 1/1 GN	3.905
DLC.SSB.03	2000 x 900 x 900 / 1550	4 x 1/1 GN	4.855
DLC.SSB.04	2400 x 900 x 900 / 1550	5 x 1/1 GN	5.815

Dolce Sıcak Servis Ünitesi Nefeslikli

Dolce Hot Service Units Chafing Dish



Kod Code	Ebatlar Dimension mm	Kapasite Capacity	Fiyatı Price Euro
DLC.SSC-N.01	1200 x 900 x 900 / 1550	1 Chafing Dish	3.575
DLC.SSC-N.02	1800 x 900 x 900 / 1550	2 Chafing Dish	5.245
DLC.SSC-N.03	2400 x 900 x 900 / 1550	3 Chafing Dish	6.950

Dolce Sıcak Servis Ünitesi

Dolce Hot Service Units Chafing Dish



Kod Code	Ebatlar Dimension mm	Kapasite Capacity	Fiyatı Price Euro
DLC.SSC.01	1200 x 900 x 900 / 1550	1 Chafing Dish	3.355
DLC.SSC.02	1800 x 900 x 900 / 1550	2 Chafing Dish	6.590
DLC.SSC.03	2400 x 900 x 900 / 1550	3 Chafing Dish	6.950

Dolce Çorba Servis Ünitesi

Dolce Soup Service Units



Kod Code	Ebatlar Dimension mm	Kapasite Capacity	Fiyatı Price Euro
DLC.CSU.01	1400 x 900 x 900	1 Çorbalık / Soup Dispenser	3.695
DLC.CSU.02	2000 x 900 x 900	2 Çorbalık / Soup Dispenser	5.385
DLC.CSU.03	2400 x 900 x 900	3 Çorbalık / Soup Dispenser	6.045

Dolce Ekmek Servis Ünitesi

Dolce Bread Service Units



Kod Code	Ebatlar Dimension mm	Fiyatı Price Euro
DLC.ESU.01	1000 x 900 x 900 / 1550	2.745
DLC.ESU.02	1200 x 900 x 900 / 1550	2.955
DLC.ESU.03	1400 x 900 x 900 / 1550	3.190
DLC.ESU.04	1600 x 900 x 900 / 1550	3.425
DLC.ESU.05	1800 x 900 x 900 / 1550	3.665
DLC.ESU.06	2000 x 900 x 900 / 1550	3.900
DLC.ESU.07	2200 x 900 x 900 / 1550	4.140
DLC.ESU.08	2400 x 900 x 900 / 1550	4.375

Dolce U Form Tabaklık

Dolce Plate Dispenser Unit



Kod Code	Ebatlar Dimension mm	Fiyatı Price Euro
DLC.UT.01	1100 x 900 x 900	2.000

Dolce Tabak Dispenseri
Dolce Plate Dispenser

Kod Code	Ebatlar Dimension mm	Kapasite Capacity	Fiyatı Price Euro
DLC.TD.01	1100 x 900 x 900	2 Tabaklı / Plate Isıtmalı / Heated	2.700
DLC.TD.02	1100 x 900 x 900	2 Tabaklı / Plate Nötr / Neutral	2.200





- Sandra Nötr Servis Ünitesi / Sandra Nötr Service Units**
- Sandra Nötr Servis Ünitesi Nefeslikli / Sandra Nötr Service Units**
- Sandra Soğuk Servis Ünitesi Nefeslikli / Sandra Cold Service Unit**
- Sandra Paslanmaz Soğuk Servis Ünitesi Nefeslikli / Sandra S/S Cold Service Units**
- Sandra Sıcak Servis Ünitesi (Benmari - Nefeslikli) / Sandra Hot Service Units (Bainmarie)**
- Sandra Sıcak Servis Ünitesi Nefeslikli / Sandra Hot Service Units Chafing Dish**
- Sandra Sıcak Servis Ünitesi / Sandra Hot Service Units Chafing Dish**
- Sandra Çorba Servis Ünitesi / Sandra Soup Service Units**
- Sandra Ekmek Servis Ünitesi / Sandra Bread Service Units**
- Sandra U Form Tabaklık / Sandra Plate Dispenser Unit**
- Sandra Tabak Dispenseri / Sandra Plate Dispenser**

Sandra Nötr Servis Ünitesi
Sandra Nötr Service Units



Kod Code	Ebatlar Dimension mm	Fiyatı Price Euro
SND.NTR.01	1000 x 900 x 900	1.735
SND.NTR.02	1200 x 900 x 900	1.945
SND.NTR.03	1400 x 900 x 900	2.150
SND.NTR.04	1600 x 900 x 900	2.355
SND.NTR.05	1800 x 900 x 900	2.565
SND.NTR.06	2000 x 900 x 900	2.770
SND.NTR.07	2200 x 900 x 900	2.980
SND.NTR.08	2400 x 900 x 900	3.180

Sandra Nötr Servis Ünitesi Nefeslikli
Sandra Nötr Service Units



Kod Code	Ebatlar Dimension mm	Fiyatı Price Euro
SND.NTR-N.01	1000 x 900 x 900 / 1550	1.955
SND.NTR-N.02	1200 x 900 x 900 / 1550	2.185
SND.NTR-N.03	1400 x 900 x 900 / 1550	2.410
SND.NTR-N.04	1600 x 900 x 900 / 1550	2.635
SND.NTR-N.05	1800 x 900 x 900 / 1550	2.865
SND.NTR-N.06	2000 x 900 x 900 / 1550	3.090
SND.NTR-N.07	2200 x 900 x 900 / 1550	3.315
SND.NTR-N.08	2400 x 900 x 900 / 1550	3.540

Sandra Soğuk Servis Ünitesi Nefeslikli

Sandra Cold Service Unit



Kod Code	Ebatlar Dimension mm	Fiyatı Price Euro
SND.SSU-N.01	1000 x 900 x 900 / 1550	3.220
SND.SSU-N.02	1200 x 900 x 900 / 1550	3.400
SND.SSU-N.03	1400 x 900 x 900 / 1550	3.600
SND.SSU-N.04	1600 x 900 x 900 / 1550	4.100
SND.SSU-N.05	1800 x 900 x 900 / 1550	4.310
SND.SSU-N.06	2000 x 900 x 900 / 1550	4.515
SND.SSU-N.07	2200 x 900 x 900 / 1550	4.800
SND.SSU-N.08	2400 x 900 x 900 / 1550	5.095

Sandra Paslanmaz Soğuk Servis Ünitesi Nefeslikli

Sandra S/S Cold Service Units



Kod Code	Ebatlar Dimension mm	Fiyatı Price Euro
SND.P.SSU.01	1000 x 900 x 900 / 1550	3.320
SND.P.SSU.02	1200 x 900 x 900 / 1550	3.510
SND.P.SSU.03	1400 x 900 x 900 / 1550	3.720
SND.P.SSU.04	1600 x 900 x 900 / 1550	4.230
SND.P.SSU.05	1800 x 900 x 900 / 1550	4.445
SND.P.SSU.06	2000 x 900 x 900 / 1550	4.655
SND.P.SSU.07	2200 x 900 x 900 / 1550	4.870
SND.P.SSU.08	2400 x 900 x 900 / 1550	5.255



Sandra Sıcak Servis Ünitesi (Benmari - Nefeslikli)
Sandra Hot Service Units (Bainmarie)



Kod Code	Ebatlar Dimension mm	Kapasite Capacity	Fiyatı Price Euro
SND.SSB.01	1200 x 900 x 900 / 1550	2 x 1/1 GN	2.570
SND.SSB.02	1600 x 900 x 900 / 1550	3 x 1/1 GN	3.395
SND.SSB.03	2000 x 900 x 900 / 1550	4 x 1/1 GN	4.225
SND.SSB.04	2400 x 900 x 900 / 1550	5 x 1/1 GN	5.055



Sandra Sıcak Servis Ünitesi Nefeslikli
Sandra Hot Service Units Chafing Dish

Kod Code	Ebatlar Dimension mm	Kapasite Capacity	Fiyatı Price Euro
SND.SSC-N.01	1200 x 900 x 900 / 1550	1 Chafing Dish	3.135
SND.SSC-N.02	1800 x 900 x 900 / 1550	2 Chafing Dish	4.625
SND.SSC-N.03	2400 x 900 x 900 / 1550	3 Chafing Dish	6.085

Sandra Sıcak Servis Ünitesi

Sandra Hot Service Units Chafing Dish



Kod Code	Ebatlar Dimension mm	Kapasite Capacity	Fiyatı Price Euro
SND.SSC.01	1200 x 900 x 900 / 1550	1 Chafing Dish	2.915
SND.SSC.02	1800 x 900 x 900 / 1550	2 Chafing Dish	4.325
SND.SSC.03	2400 x 900 x 900 / 1550	3 Chafing Dish	5.730

Sandra Çorba Servis Ünitesi

Sandra Soup Service Units



Kod Code	Ebatlar Dimension mm	Kapasite Capacity	Fiyatı Price Euro
SND.CSU.01	1400 x 900 x 900	1 Çorbalık / Soup Dispenser	3.215
SND.CSU.02	2000 x 900 x 900	2 Çorbalık / Soup Dispenser	4.680
SND.CSU.03	2400 x 900 x 900	3 Çorbalık / Soup Dispenser	5.095

Sandra Ekmek Servis Ünitesi
Sandra Bread Service Units



Kod Code	Ebatlar Dimension mm	Fiyatı Price Euro
SND.ESU.01	1000 x 900 x 900 / 1550	2.390
SND.ESU.02	1200 x 900 x 900 / 1550	2.570
SND.ESU.03	1400 x 900 x 900 / 1550	2.800
SND.ESU.04	1600 x 900 x 900 / 1550	2.980
SND.ESU.05	1800 x 900 x 900 / 1550	3.190
SND.ESU.06	2000 x 900 x 900 / 1550	3.395
SND.ESU.07	2200 x 900 x 900 / 1550	3.600
SND.ESU.08	2400 x 900 x 900 / 1550	3.805

Sandra U Form Tabaklık
Sandra Plate Dispenser Unit



Kod Code	Ebatlar Dimension mm	Fiyatı Price Euro
SND.UT.01	1100 x 900 x 900	2.000

Sandra Tabak Dispenseri
Sandra Plate Dispenser



Kod Code	Ebatlar Dimension mm	Kapasite Capacity	Fiyatı Price Euro
SND.TD.01	1100 x 900 x 900	2 Tabaklı / Plate Isıtmalı / Heated	2.700
SND.TD.02	1100 x 900 x 900	2 Tabaklı / Plate Nötr / Neutral	2.200





Monarc Nötr Servis Ünitesi / Monarc Nötr Service Units

Monarc Nötr Servis Ünitesi Nefeslikli / Monarc Nötr Service Units

Monarc Soğuk Servis Ünitesi Nefeslikli / Monarc Cold Service Unit

Monarc Paslanmaz Soğuk Servis Ünitesi Nefeslikli / Monarc S/S Cold Service Units

Monarc Sıcak Servis Ünitesi (Benmari - Nefeslikli) / Monarc Hot Service Units (Bainmarie)

Monarc Sıcak Servis Ünitesi Nefeslikli / Monarc Hot Service Units Chafing Dish

Monarc Sıcak Servis Ünitesi / Monarc Hot Service Units Chafing Dish

Monarc Çorba Servis Ünitesi / Monarc Soup Service Units

Monarc Ekmek Servis Ünitesi / Monarc Bread Service Units

Monarc U Form Tabaklık / Monarc Plate Dispenser Unit

Monarc Tabak Dispenseri / Monarc Plate Dispenser

Monarc Nötr Servis Ünitesi

Monarc Nötr Service Units



Kod Code	Ebatlar Dimension mm	Fiyatı Price Euro
MNR.NTR.01	1000 x 900 x 900	1.845
MNR.NTR.02	1200 x 900 x 900	2.035
MNR.NTR.03	1400 x 900 x 900	2.250
MNR.NTR.04	1600 x 900 x 900	2.465
MNR.NTR.05	1800 x 900 x 900	2.680
MNR.NTR.06	2000 x 900 x 900	2.895
MNR.NTR.07	2200 x 900 x 900	3.110
MNR.NTR.08	2400 x 900 x 900	3.325

Monarc Nötr Servis Ünitesi Nefeslikli

Monarc Nötr Service Units



Kod Code	Ebatlar Dimension mm	Fiyatı Price Euro
MNR.NTR-N.01	1000 x 900 x 900 / 1450	2.065
MNR.NTR-N.02	1200 x 900 x 900 / 1450	2.275
MNR.NTR-N.03	1400 x 900 x 900 / 1450	2.500
MNR.NTR-N.04	1600 x 900 x 900 / 1450	2.745
MNR.NTR-N.05	1800 x 900 x 900 / 1450	2.975
MNR.NTR-N.06	2000 x 900 x 900 / 1450	3.215
MNR.NTR-N.07	2200 x 900 x 900 / 1450	3.450
MNR.NTR-N.08	2400 x 900 x 900 / 1450	3.685

Monarc Soğuk Servis Ünitesi Nefeslikli
Monarc Cold Service Unit



Kod Code	Ebatlar Dimension mm	Fiyatı Price Euro
MNR.SSU-N.01	1000 x 900 x 900 / 1450	3.300
MNR.SSU-N.02	1200 x 900 x 900 / 1450	3.490
MNR.SSU-N.03	1400 x 900 x 900 / 1450	3.705
MNR.SSU-N.04	1600 x 900 x 900 / 1450	4.215
MNR.SSU-N.05	1800 x 900 x 900 / 1450	4.425
MNR.SSU-N.06	2000 x 900 x 900 / 1450	4.640
MNR.SSU-N.07	2200 x 900 x 900 / 1450	4.860
MNR.SSU-N.08	2400 x 900 x 900 / 1450	5.235

Monarc Paslanmaz Soğuk Servis Ünitesi Nefeslikli
Monarc S/S Cold Service Units



Kod Code	Ebatlar Dimension mm	Fiyatı Price Euro
MNR.P.SSU.01	1000 x 900 x 900 / 1450	3.400
MNR.P.SSU.02	1200 x 900 x 900 / 1450	3.600
MNR.P.SSU.03	1400 x 900 x 900 / 1450	3.820
MNR.P.SSU.04	1600 x 900 x 900 / 1450	4.345
MNR.P.SSU.05	1800 x 900 x 900 / 1450	4.565
MNR.P.SSU.06	2000 x 900 x 900 / 1450	4.785
MNR.P.SSU.07	2200 x 900 x 900 / 1450	5.010
MNR.P.SSU.08	2400 x 900 x 900 / 1450	5.400

Monarc Sıcak Servis Ünitesi (Benmari - Nefeslikli)

Monarc Hot Service Units (Bainmarie)



Kod Code	Ebatlar Dimension mm	Kapasite Capacity	Fiyatı Price Euro
MNR.SSB.01	1200 x 900 x 900 / 1550	2 x 1/1 GN	2.655
MNR.SSB.02	1600 x 900 x 900 / 1550	3 x 1/1 GN	3.505
MNR.SSB.03	2000 x 900 x 900 / 1550	4 x 1/1 GN	4.350
MNR.SSB.04	2400 x 900 x 900 / 1550	5 x 1/1 GN	5.200

Monarc Sıcak Servis Ünitesi Nefeslikli

Monarc Hot Service Units Chafing Dish



Kod Code	Ebatlar Dimension mm	Kapasite Capacity	Fiyatı Price Euro
MNR.SSC-N.01	1200 x 900 x 900 / 1550	1 Chafing Dish	3.205
MNR.SSC-N.02	1800 x 900 x 900 / 1550	2 Chafing Dish	4.740
MNR.SSC-N.03	2400 x 900 x 900 / 1550	3 Chafing Dish	6.235

Monarc Sıcak Servis Ünitesi Monarc Hot Service Units Chafing Dish



Kod Code	Ebatlar Dimension mm	Kapasite Capacity	Fiyatı Price Euro
MNR.SSC.01	1200 x 900 x 900 / 1550	1 Chafing Dish	3.005
MNR.SSC.02	1800 x 900 x 900 / 1550	2 Chafing Dish	4.440
MNR.SSC.03	2400 x 900 x 900 / 1550	3 Chafing Dish	5.875

Monarc Çorba Servis Ünitesi Monarc Soup Service Units



Kod Code	Ebatlar Dimension mm	Kapasite Capacity	Fiyatı Price Euro
MNR.CSU.01	1400 x 900 x 900	1 Çorbalık / Soup Dispenser	3.310
MNR.CSU.02	2000 x 900 x 900	2 Çorbalık / Soup Dispenser	4.800
MNR.CSU.03	2400 x 900 x 900	3 Çorbalık / Soup Dispenser	5.240

Monarc Ekmek Servis Ünitesi Monarc Bread Service Units



Kod Code	Ebatlar Dimension mm	Fiyatı Price Euro
MNR.ESU.01	1000 x 900 x 900 / 1550	2.470
MNR.ESU.02	1200 x 900 x 900 / 1550	2.655
MNR.ESU.03	1400 x 900 x 900 / 1550	2.875
MNR.ESU.04	1600 x 900 x 900 / 1550	3.090
MNR.ESU.05	1800 x 900 x 900 / 1550	3.300
MNR.ESU.06	2000 x 900 x 900 / 1550	3.520
MNR.ESU.07	2200 x 900 x 900 / 1550	3.575
MNR.ESU.08	2400 x 900 x 900 / 1550	3.950

Monarc U Form Tabaklık Monarc Plate Dispenser Unit



Kod Code	Ebatlar Dimension mm	Fiyatı Price Euro
MNR.UT.01	1100 x 900 x 900	2.000

Monarc Tabak Dispenseri
Monarc Plate Dispenser

Kod Code	Ebatlar Dimension mm	Kapasite Capacity	Fiyatı Price Euro
MNR.TD.01	1100 x 900 x 900	2 Tabaklı / Plate Isıtmalı / Heated	2.700
MNR.TD.02	1100 x 900 x 900	2 Tabaklı / Plate Nötr / Neutral	2.200





Elora Nötr Servis Ünitesi / Elora Nötr Service Units

Elora Nötr Servis Ünitesi Nefeslikli / Elora Nötr Service Units

Elora Soğuk Servis Ünitesi Nefeslikli / Elora Cold Service Unit

Elora Paslanmaz Soğuk Servis Ünitesi Nefeslikli / Elora S/S Cold Service Units

Elora Sıcak Servis Ünitesi (Benmari - Nefeslikli) / Elora Hot Service Units (Bainmarie)

Elora Sıcak Servis Ünitesi Nefeslikli / Elora Hot Service Units Chafing Dish

Elora Sıcak Servis Ünitesi / Elora Hot Service Units Chafing Dish

Elora Çorba Servis Ünitesi / Elora Soup Service Units

Elora Ekmek Servis Ünitesi / Elora Bread Service Units

Elora U Form Tabaklık / Elora Plate Dispenser Unit

Elora Tabak Dispenseri / Elora Plate Dispenser

Elora Nötr Servis Ünitesi Elora Nötr Service Units



Kod Code	Ebatlar Dimension mm	Fiyatı Price Euro
ELR.NTR.01	1000 x 900 x 900	1.925
ELR.NTR.02	1200 x 900 x 900	2.125
ELR.NTR.03	1400 x 900 x 900	2.345
ELR.NTR.04	1600 x 900 x 900	2.570
ELR.NTR.05	1800 x 900 x 900	2.795
ELR.NTR.06	2000 x 900 x 900	3.020
ELR.NTR.07	2200 x 900 x 900	3.245
ELR.NTR.08	2400 x 900 x 900	3.470



Elora Nötr Servis Ünitesi Nefeslikli Elora Nötr Service Units

Kod Code	Ebatlar Dimension mm	Fiyatı Price Euro
ELR.NTR-N.01	1000 x 900 x 900 / 1550	2.145
ELR.NTR-N.02	1200 x 900 x 900 / 1550	2.365
ELR.NTR-N.03	1400 x 900 x 900 / 1550	2.600
ELR.NTR-N.04	1600 x 900 x 900 / 1550	2.850
ELR.NTR-N.05	1800 x 900 x 900 / 1550	3.095
ELR.NTR-N.06	2000 x 900 x 900 / 1550	3.340
ELR.NTR-N.07	2200 x 900 x 900 / 1550	3.585
ELR.NTR-N.08	2400 x 900 x 900 / 1550	3.830

Elora Soğuk Servis Ünitesi Nefeslikli

Elora Cold Service Unit



Kod Code	Ebatlar Dimension mm	Fiyatı Price Euro
ELR.SSU-N.01	1000 x 900 x 900 / 1550	3.380
ELR.SSU-N.02	1200 x 900 x 900 / 1550	3.575
ELR.SSU-N.03	1400 x 900 x 900 / 1550	3.800
ELR.SSU-N.04	1600 x 900 x 900 / 1550	4.315
ELR.SSU-N.05	1800 x 900 x 900 / 1550	4.545
ELR.SSU-N.06	2000 x 900 x 900 / 1550	4.770
ELR.SSU-N.07	2200 x 900 x 900 / 1550	4.990
ELR.SSU-N.08	2400 x 900 x 900 / 1550	5.385

Elora Paslanmaz Soğuk Servis Ünitesi Nefeslikli

Elora S/S Cold Service Units



Kod Code	Ebatlar Dimension mm	Fiyatı Price Euro
ELR.P.SSU.01	1000 x 900 x 900 / 1550	3.485
ELR.P.SSU.02	1200 x 900 x 900 / 1550	3.690
ELR.P.SSU.03	1400 x 900 x 900 / 1550	3.920
ELR.P.SSU.04	1600 x 900 x 900 / 1550	4.455
ELR.P.SSU.05	1800 x 900 x 900 / 1550	4.685
ELR.P.SSU.06	2000 x 900 x 900 / 1550	4.915
ELR.P.SSU.07	2200 x 900 x 900 / 1550	5.150
ELR.P.SSU.08	2400 x 900 x 900 / 1550	5.550

Elora Sıcak Servis Ünitesi (Benmari - Nefeslikli)

Elora Hot Service Units (Bainmarie)



Kod Code	Ebatlar Dimension mm	Kapasite Capacity	Fiyatı Price Euro
ELR.SSB.01	1200 x 900 x 900 / 1550	2 x 1/1 GN	2.745
ELR.SSB.02	1600 x 900 x 900 / 1550	3 x 1/1 GN	3.720
ELR.SSB.03	2000 x 900 x 900 / 1550	4 x 1/1 GN	4.615
ELR.SSB.04	2400 x 900 x 900 / 1550	5 x 1/1 GN	5.510



Elora Sıcak Servis Ünitesi Nefeslikli

Elora Hot Service Units Chafing Dish

Kod Code	Ebatlar Dimension mm	Kapasite Capacity	Fiyatı Price Euro
ELR.SSC-N.01	1200 x 900 x 900 / 1550	1 Chafing Dish	3.315
ELR.SSC-N.02	1800 x 900 x 900 / 1550	2 Chafing Dish	4.875
ELR.SSC-N.03	2400 x 900 x 900 / 1550	3 Chafing Dish	6.375

Elora Sıcak Servis Ünitesi

Elora Hot Service Units Chafing Dish



Kod Code	Ebatlar Dimension mm	Kapasite Capacity	Fiyatı Price Euro
ELR.SSC.01	1200 x 900 x 900 / 1550	1 Chafing Dish	3.095
ELR.SSC.02	1800 x 900 x 900 / 1550	2 Chafing Dish	4.555
ELR.SSC.03	2400 x 900 x 900 / 1550	3 Chafing Dish	6.015

Elora Çorba Servis Ünitesi

Elora Soup Service Units



Kod Code	Ebatlar Dimension mm	Kapasite Capacity	Fiyatı Price Euro
ELR.CSU.01	1400 x 900 x 900	1 Çorbalık / Soup Dispenser	3.410
ELR.CSU.02	2000 x 900 x 900	2 Çorbalık / Soup Dispenser	4.935
ELR.CSU.03	2400 x 900 x 900	3 Çorbalık / Soup Dispenser	5.408

Elora Ekmek Servis Ünitesi
Elora Bread Service Units

Kod Code	Ebatlar Dimension mm	Fiyatı Price Euro
ELR.ESU.01	1000 x 900 x 900 / 1550	2.545
ELR.ESU.02	1200 x 900 x 900 / 1550	2.745
ELR.ESU.03	1400 x 900 x 900 / 1550	2.970
ELR.ESU.04	1600 x 900 x 900 / 1550	3.195
ELR.ESU.05	1800 x 900 x 900 / 1550	3.420
ELR.ESU.06	2000 x 900 x 900 / 1550	3.645
ELR.ESU.07	2200 x 900 x 900 / 1550	3.870
ELR.ESU.08	2400 x 900 x 900 / 1550	4.095

Elora U Form Tabaklık
Elora Plate Dispenser Unit

Kod Code	Ebatlar Dimension mm	Fiyatı Price Euro
ELR.UT.01	1100 x 900 x 900	2.000

Elora Tabak Dispenseri
Elora Plate Dispenser

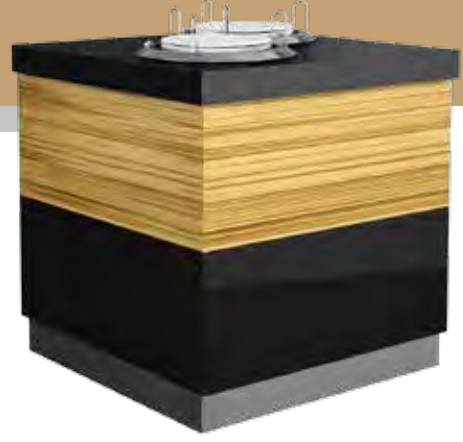

Kod Code	Ebatlar Dimension mm	Kapasite Capacity	Fiyatı Price Euro
ELR.TD.01	1100 x 900 x 900	2 Tabaklı / Plate Isıtmalı / Heated	2.700
ELR.TD.02	1100 x 900 x 900	2 Tabaklı / Plate Nötr / Neutral	2.200





G|R|O|U|P

empero@empero.com.tr

Raflar
Shelves



empero@empero.com.tr



Polipropilen Raflar - Delikli / Polipropilen Shelves - Perforated
Polipropilen Raflar - Delikli Tablalı / Polipropilen Shelves - Perforated
Polipropilen Raflar - Düz / Polipropilen Shelves - Smooth
Polipropilen Raflar - Düz Tablalı / Polipropilen Shelves - Smooth
Tel Raflar / Wire Shelves
Tel Raflar / Wire Shelves
Tel Raflar 4 Katlı (1600 mm) / Wire Shelves With 4 Floor (1600 mm)
Tel Raflar 4 Katlı (1600 mm) / Wire Shelves With 4 Floor (1600 mm)
Tel Raflar 4 Katlı (1800 mm) / Wire Shelves With 4 Floor (1800 mm)
Tel Raflar 4 Katlı (1800 mm) / Wire Shelves With 4 Floor (1800 mm)
Düz Raflar / Smooth Shelves
Düz Raflar / Smooth Shelves
Düz Raflar 4 Katlı (1600 mm) / Smooth Shelves With 4 Floor (1600 mm)
Düz Raflar 4 Katlı (1600 mm) / Smooth Shelves With 4 Floor (1600 mm)
Düz Raflar 4 Katlı (1800 mm) / Smooth Shelves With 4 Floor (1800 mm)
Düz Raflar 4 Katlı (1800 mm) / Smooth Shelves With 4 Floor (1800 mm)
Delikli Raflar / Perforated Shelves
Delikli Raflar / Perforated Shelves
Delikli Raflar 4 Katlı (1600 mm) / Perforated Shelves With 4 Floor (1600 mm)
Delikli Raflar 4 Katlı (1600 mm) / Perforated Shelves With 4 Floor (1600 mm)
Delikli Raflar 4 Katlı (1800 mm) / Perforated Shelves With 4 Floor (1800 mm)
Delikli Raflar 4 Katlı (1800 mm) / Perforated Shelves With 4 Floor (1800 mm)
Mutfak Bulaşık Arabaları / Soiled Dish Trolleys
Mutfak Bulaşık Arabaları / Soiled Dish Trolleys
Servis Arabaları / Service Trolleys
Taşıma ve Muhafaza Arabaları / Mobile Storage Bins and Transport Carts
Taşıma ve Muhafaza Arabaları / Mobile Storage Bins and Transport Carts
Tabak Otomatları / Plate Dispensers
Yer Filtreleri Alttan Çıkışlı / Floor Filters Bottom Outlet
Tel Izgaralar / Wire Grid
Davlumbaz Filtreleri / Hood Filters
Yağ Ayırtıcı / Grease Separator

Polipropilen Raflar - Delikli
Polipropilen Shelves - Perforated



Delikli Raf Plakaları
Perforated Shelf Plates

En:40 cm

Kod Code	Ebatlar Dimension mm	Fiyatı Price Euro
EMP.4097-D	970x400	31
EMP.40127-D	1270x400	39
EMP.40157-D	1570x400	45

En:50 cm

Kod Code	Ebatlar Dimension mm	Fiyatı Price Euro
EMP.5097-D	970x500	32
EMP.50127-D	1270x500	40
EMP.50157-D	1570x500	49

En:60 cm

Kod Code	Ebatlar Dimension mm	Fiyatı Price Euro
EMP.6097-D	970x600	36
EMP.60127-D	1270x600	45
EMP.60157-D	1570x600	54

Alüminyum Raf Ayakları
Aluminium Shelf Posts

Kod Code	Ebatlar Dimension mm	Fiyatı Price Euro
EMP.1800-A	1800	75
EMP.1800-A-H	1800	105



EMP.1800-A-H

EMP.1800-A



Kod Code	Ürün Adı Description	Fiyatı Price Euro
EMP.1800.KS	Köşe Aparatı Corner Part	18



Türkçe

POLİPROPİLEN RAFLAR - DELİKLİ TABLALI

- Hijyenik polipropilen tabla.
- Alüminyum ayak.
- Sökülebilir, yıkanılabilir tabla özelliği.
- Nemli, kuru, soğuk ve sıcak hava koşullarına dayanıklılık.

Her kat için 140 kg taşıma kapasitesi
140 Kg capacity for each shelf

English

POLIPROPILEN SHELVES - PERFORATED

- Hygienic polypropylene shelf.
- Aluminum feet.
- Removable, washable shelves.
- Endurance in case of; wet, dry, cold and hot environments.

Polipropilen Raflar - Delikli Tablalı
Polipropilen Shelves - Perforated

En:40 cm

Kod Code	Ebatlar Dimension mm	Fiyatı Price Euro
EMP.4097-18-D	970x400x1800	274
EMP.40127-18-D	1270x400x1800	306
EMP.40157-18-D	1570x400x1800	330
EMP.40190-18-D	1905x400x1800	473
EMP.40220-18-D	2205x400x1800	505
EMP.40250-18-D	2505x400x1800	537
EMP.40280-18-D	2805x400x1800	561
EMP.40310-18-D	3105x400x1800	585
EMP.40344-18-D	3440x400x1800	736
EMP.40374-18-D	3740x400x1800	768
EMP.40404-18-D	4040x400x1800	792
EMP.40434-18-D	4340x400x1800	840
EMP.40467-18-D	4675x400x1800	967
EMP.40497-18-D	4975x400x1800	999
EMP.40527-18-D	5275x400x1800	1.023
EMP.40557-18-D	5575x400x1800	1.047
EMP.40587-18-D	5875x400x1800	1.071
EMP.40617-18-D	6175x400x1800	1.095

En:50 cm

Kod Code	Ebatlar Dimension mm	Fiyatı Price Euro
EMP.5097-18-D	970x500x1800	278
EMP.50127-18-D	1270x500x1800	310
EMP.50157-18-D	1570x500x1800	346
EMP.50190-18-D	1905x500x1800	481
EMP.50220-18-D	2205x500x1800	513
EMP.50250-18-D	2505x500x1800	545
EMP.50280-18-D	2805x500x1800	581
EMP.50310-18-D	3105x500x1800	617
EMP.50344-18-D	3440x500x1800	748
EMP.50374-18-D	3740x500x1800	780
EMP.50404-18-D	4040x500x1800	816
EMP.50434-18-D	4340x500x1800	888
EMP.50467-18-D	4675x500x1800	983
EMP.50497-18-D	4975x500x1800	1.015
EMP.50527-18-D	5275x500x1800	1.051
EMP.50557-18-D	5575x500x1800	1.087
EMP.50587-18-D	5875x500x1800	1.123
EMP.50617-18-D	6175x500x1800	1.159

En:60 cm

Kod Code	Ebatlar Dimension mm	Fiyatı Price Euro
EMP.6097-18-D	970x600x1800	294
EMP.60127-18-D	1270x600x1800	330
EMP.60157-18-D	1570x600x1800	366
EMP.60190-18-D	1905x600x1800	513
EMP.60220-18-D	2205x600x1800	549
EMP.60250-18-D	2505x600x1800	585
EMP.60280-18-D	2805x600x1800	621
EMP.60310-18-D	3105x600x1800	657
EMP.60344-18-D	3440x600x1800	804
EMP.60374-18-D	3740x600x1800	840
EMP.60404-18-D	4040x600x1800	876
EMP.60434-18-D	4340x600x1800	948
EMP.60467-18-D	4675x600x1800	1.059
EMP.60497-18-D	4975x600x1800	1.095
EMP.60527-18-D	5275x600x1800	1.131
EMP.60557-18-D	5575x600x1800	1.167
EMP.60587-18-D	5875x600x1800	1.203
EMP.60617-18-D	6175x600x1800	1.239

Türkçe
POLİPROPİLEN RAFLAR - DELİKLİ TABLALI

- Hijyenik polipropilen tabla.
- Alüminyum ayak.
- Sökülebilir, yıkanılabilir tabla özelliği.
- Nemli, kuru, soğuk ve sıcak hava koşullarına dayanıklılık.

Her kat için 140 kg taşıma kapasitesi
140 Kg capacity for each shelf

English
POLIPROPILEN SHELVES - PERFORATED

- Hygienic polypropene shelfe.
- Aluminum feet.
- Removable, washable shelves.
- Endurance in case of; wet, dry, cold and hot enviroments.

Polipropilen Raflar - Düz
Polipropilen Shelves - Smooth



Düz Raf Plakaları
Smooth Shelf Plates



En:40 cm

Kod Code	Ebatlar Dimension mm	Fiyatı Price Euro
EMP.4097	970x400	34
EMP.40127	1270x400	42
EMP.40157	1570x400	51

En:50 cm

Kod Code	Ebatlar Dimension mm	Fiyatı Price Euro
EMP.5097	970x500	35
EMP.50127	1270x500	44
EMP.50157	1570x500	53

En:60 cm

Kod Code	Ebatlar Dimension mm	Fiyatı Price Euro
EMP.6097	970x600	38
EMP.60127	1270x600	48
EMP.60157	1570x600	58

Alüminyum Raf Ayakları
Aluminium Shelf Posts

Kod Code	Ebatlar Dimension mm	Fiyatı Price Euro
EMP.1800-A	1800	75
EMP.1800-A-H	1800	105

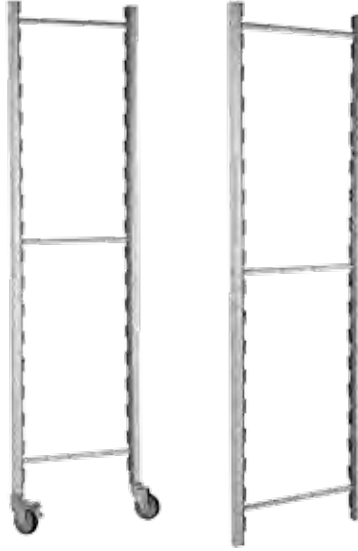

EMP.1800-A-H

EMP.1800-A



Kod Code	Ürün Adı Description	Fiyatı Price Euro
EMP.1800.KS	Köşe Aparatı Corner Part	18



Türkçe

POLİPROPİLEN RAFLAR - DÜZ TABLALI

- Hijyenik polipropilen tabla.
- Alüminyum ayak.
- Sökülebilir, yıkanılabilir tabla özelliği.
- Nemli, kuru, soğuk ve sıcak hava koşullarına dayanıklılık.

Her kat için 140 kg taşıma kapasitesi
140 Kg capacity for each shelf

English

POLIPROPILEN SHELVES - SMOOTH

- Hygienic polypropene shelve.
- Aluminum feet.
- Removable, washable shelves.
- Endurance in case of; wet, dry, cold and hot enviroments.

Polipropilen Raflar - Düz Tablalı
 Polipropilen Shelves - Smooth

En:40 cm

Kod Code	Ebatlar Dimension mm	Fiyatı Price Euro
EMP.4097-18	970x400x1800	286
EMP.40127-18	1270x400x1800	318
EMP.40157-18	1570x400x1800	354
EMP.40190-18	1905x400x1800	497
EMP.40220-18	2205x400x1800	529
EMP.40250-18	2505x400x1800	561
EMP.40280-18	2805x400x1800	597
EMP.40310-18	3105x400x1800	633
EMP.40344-18	3440x400x1800	772
EMP.40374-18	3740x400x1800	804
EMP.40404-18	4040x400x1800	840
EMP.40434-18	4340x400x1800	912
EMP.40467-18	4675x400x1800	1.015
EMP.40497-18	4975x400x1800	1.047
EMP.40527-18	5275x400x1800	1.083
EMP.40557-18	5575x400x1800	1.119
EMP.40587-18	5875x400x1800	1.155
EMP.40617-18	6175x400x1800	1.191

En:50 cm

Kod Code	Ebatlar Dimension mm	Fiyatı Price Euro
EMP.5097-18	970x500x1800	290
EMP.50127-18	1270x500x1800	326
EMP.50157-18	1570x500x1800	362
EMP.50190-18	1905x500x1800	505
EMP.50220-18	2205x500x1800	541
EMP.50250-18	2505x500x1800	577
EMP.50280-18	2805x500x1800	613
EMP.50310-18	3105x500x1800	649
EMP.50344-18	3440x500x1800	792
EMP.50374-18	3740x500x1800	818
EMP.50404-18	4040x500x1800	864
EMP.50434-18	4340x500x1800	936
EMP.50467-18	4675x500x1800	1.043
EMP.50497-18	4975x500x1800	1.079
EMP.50527-18	5275x500x1800	1.115
EMP.50557-18	5575x500x1800	1.151
EMP.50587-18	5875x500x1800	1.187
EMP.50617-18	6175x500x1800	1.223

En:60 cm

Kod Code	Ebatlar Dimension mm	Fiyatı Price Euro
EMP.6097-18	970x600x1800	302
EMP.60127-18	1270x600x1800	342
EMP.60157-18	1570x600x1800	382
EMP.60190-18	1905x600x1800	529
EMP.60220-18	2205x600x1800	569
EMP.60250-18	2505x600x1800	609
EMP.60280-18	2805x600x1800	644
EMP.60310-18	3105x600x1800	689
EMP.60344-18	3440x600x1800	836
EMP.60374-18	3740x600x1800	876
EMP.60404-18	4040x600x1800	916
EMP.60434-18	4340x600x1800	996
EMP.60467-18	4675x600x1800	1.103
EMP.60497-18	4975x600x1800	1.143
EMP.60527-18	5275x600x1800	1.183
EMP.60557-18	5575x600x1800	1.223
EMP.60587-18	5875x600x1800	1.263
EMP.60617-18	6175x600x1800	1.303

Türkçe
POLİPROPİLEN RAFLAR - DÜZ TABLALI

- Hijyenik polipropilen tabla.
- Alüminyum ayak.
- Sökülebilir, yıkanılabilir tabla özelliği.
- Nemli, kuru, soğuk ve sıcak hava koşullarına dayanıklılık.

English
POLIPROPILEN SHELVES - SMOOTH

- Hygienic polypropylene shelves.
- Aluminum feet.
- Removable, washable shelves.
- Endurance in case of; wet, dry, cold and hot environments.

Her kat için 140 kg taşıma kapasitesi
140 Kg capacity for each shelf

Tel Raflar
Wire Shelves

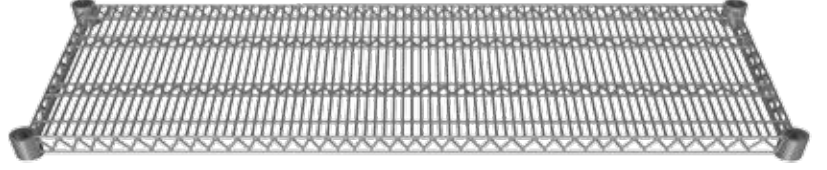

INOX 304

Kod Code	Ebatlar Dimension mm	Fiyatı Price Euro
EMP.T.3.3676	360x760	35
EMP.T.3.3691	360x910	40
EMP.T.3.36107	360x1070	46
EMP.T.3.36122	360x1220	51
EMP.T.3.36137	360x1370	56
EMP.T.3.36152	360x1520	66
EMP.T.3.36183	360x1830	78

INOX 201

Kod Code	Ebatlar Dimension mm	Fiyatı Price Euro
EMP.T.2.3676	360x760	26
EMP.T.2.3691	360x910	29
EMP.T.2.36107	360x1070	33
EMP.T.2.36122	360x1220	36
EMP.T.2.36137	360x1370	40
EMP.T.2.36152	360x1520	47
EMP.T.2.36183	360x1830	54

Kod Code	Ebatlar Dimension mm	Fiyatı Price Euro
EMP.T.3.4676	460x760	40
EMP.T.3.4691	460x910	46
EMP.T.3.46107	460x1070	52
EMP.T.3.46122	460x1220	57
EMP.T.3.46137	460x1370	68
EMP.T.3.46152	460x1520	75
EMP.T.3.46183	460x1830	87

Kod Code	Ebatlar Dimension mm	Fiyatı Price Euro
EMP.T.2.4676	460x760	32
EMP.T.2.4691	460x910	36
EMP.T.2.46107	460x1070	38
EMP.T.2.46122	460x1220	41
EMP.T.2.46137	460x1370	48
EMP.T.2.46152	460x1520	52
EMP.T.2.46183	460x1830	61

INOX 304

Kod Code	Ebatlar Dimension mm	Fiyatı Price Euro
EMP.1600-3	1600	29
EMP.1800-3	1800	32
EMP.1600-3-H	1600	45
EMP.1800-3-H	1800	49

INOX 201

Kod Code	Ebatlar Dimension mm	Fiyatı Price Euro
EMP.1600-2	1600	23
EMP.1800-2	1800	24
EMP.1600-2-H	1600	39
EMP.1800-2-H	1800	41



EMP.1600-3 EMP.1800-3-H

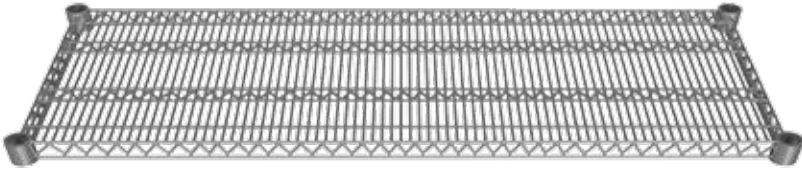

INOX 304

INOX 201

Kod Code	Ebatlar Dimension mm	Fiyatı Price Euro
EMP.T.3.5376	530x760	42
EMP.T.3.5391	530x910	49
EMP.T.3.53107	530x1070	57
EMP.T.3.53122	530x1220	72
EMP.T.3.53137	530x1370	79
EMP.T.3.53152	530x1520	85
EMP.T.3.53183	530x1830	100

Kod Code	Ebatlar Dimension mm	Fiyatı Price Euro
EMP.T.2.5376	530x760	33
EMP.T.2.5391	530x910	37
EMP.T.2.53107	530x1070	40
EMP.T.2.53122	530x1220	51
EMP.T.2.53137	530x1370	57
EMP.T.2.53152	530x1520	61
EMP.T.2.53183	530x1830	72

Kod Code	Ebatlar Dimension mm	Fiyatı Price Euro
EMP.T.3.6176	610x760	47
EMP.T.3.6191	610x910	57
EMP.T.3.61107	610x1070	68
EMP.T.3.61122	610x1220	76
EMP.T.3.61137	610x1370	85
EMP.T.3.61152	610x1520	94
EMP.T.3.61183	610x1830	105

Kod Code	Ebatlar Dimension mm	Fiyatı Price Euro
EMP.T.2.6176	610x760	36
EMP.T.2.6191	610x910	43
EMP.T.2.61107	610x1070	49
EMP.T.2.61122	610x1220	57
EMP.T.2.61137	610x1370	62
EMP.T.2.61152	610x1520	68
EMP.T.2.61183	610x1830	76

Tel Raflar 4 Katlı (1600 mm)
Wire Shelves With 4 Floor (1600 mm)



INOX 304

INOX 201

Kod Code	Ebatlar Dimension mm	Fiyatı Price Euro
EMP.T.3.3676-16-4	360x760x1600	256
EMP.T.3.3691-16-4	360x910x1600	276
EMP.T.3.36107-16-4	360x1070x1600	300
EMP.T.3.36122-16-4	360x1220x1600	320
EMP.T.3.36137-16-4	360x1370x1600	340
EMP.T.3.36152-16-4	360x1520x1600	380
EMP.T.3.36183-16-4	360x1830x1600	428

Kod Code	Ebatlar Dimension mm	Fiyatı Price Euro
EMP.T.2.3676-16-4	360x760x1600	196
EMP.T.2.3691-16-4	360x910x1600	208
EMP.T.2.36107-16-4	360x1070x1600	224
EMP.T.2.36122-16-4	360x1220x1600	236
EMP.T.2.36137-16-4	360x1370x1600	252
EMP.T.2.36152-16-4	360x1520x1600	280
EMP.T.2.36183-16-4	360x1830x1600	308

Kod Code	Ebatlar Dimension mm	Fiyatı Price Euro
EMP.T.3.4676-16-4	460x760x1600	276
EMP.T.3.4691-16-4	460x910x1600	300
EMP.T.3.46107-16-4	460x1070x1600	324
EMP.T.3.46122-16-4	460x1220x1600	344
EMP.T.3.46137-16-4	460x1370x1600	388
EMP.T.3.46152-16-4	460x1520x1600	416
EMP.T.3.46183-16-4	460x1830x1600	464

Kod Code	Ebatlar Dimension mm	Fiyatı Price Euro
EMP.T.2.4676-16-4	460x760x1600	220
EMP.T.2.4691-16-4	460x910x1600	236
EMP.T.2.46107-16-4	460x1070x1600	244
EMP.T.2.46122-16-4	460x1220x1600	256
EMP.T.2.46137-16-4	460x1370x1600	284
EMP.T.2.46152-16-4	460x1520x1600	300
EMP.T.2.46183-16-4	460x1830x1600	336



Tel Raflar 4 Katlı (1600 mm)
Wire Shelves With 4 Floor (1600 mm)



INOX 304

INOX 201

Kod Code	Ebatlar Dimension mm	Fiyatı Price Euro
EMP.T.3.5376-16-4	530x760x1600	284
EMP.T.3.5391-16-4	530x910x1600	312
EMP.T.3.53107-16-4	530x1070x1600	344
EMP.T.3.53122-16-4	530x1220x1600	404
EMP.T.3.53137-16-4	530x1370x1600	432
EMP.T.3.53152-16-4	530x1520x1600	456
EMP.T.3.53183-16-4	530x1830x1600	516

Kod Code	Ebatlar Dimension mm	Fiyatı Price Euro
EMP.T.2.5376-16-4	530x760x1600	224
EMP.T.2.5391-16-4	530x910x1600	240
EMP.T.2.53107-16-4	530x1070x1600	252
EMP.T.2.53122-16-4	530x1220x1600	296
EMP.T.2.53137-16-4	530x1370x1600	320
EMP.T.2.53152-16-4	530x1520x1600	336
EMP.T.2.53183-16-4	530x1830x1600	380

Kod Code	Ebatlar Dimension mm	Fiyatı Price Euro
EMP.T.3.6176-16-4	610x760x1600	304
EMP.T.3.6191-16-4	610x910x1600	344
EMP.T.3.61107-16-4	610x1070x1600	388
EMP.T.3.61122-16-4	610x1220x1600	420
EMP.T.3.61137-16-4	610x1370x1600	456
EMP.T.3.61152-16-4	610x1520x1600	492
EMP.T.3.61183-16-4	610x1830x1600	536

Kod Code	Ebatlar Dimension mm	Fiyatı Price Euro
EMP.T.2.6176-16-4	610x760x1600	236
EMP.T.2.6191-16-4	610x910x1600	264
EMP.T.2.61107-16-4	610x1070x1600	288
EMP.T.2.61122-16-4	610x1220x1600	320
EMP.T.2.61137-16-4	610x1370x1600	340
EMP.T.2.61152-16-4	610x1520x1600	364
EMP.T.2.61183-16-4	610x1830x1600	396



Tel Raflar 4 Katlı (1800 mm)
Wire Shelves With 4 Floor (1800 mm)



INOX 304

Kod Code	Ebatlar Dimension mm	Fiyati Price Euro
EMP.T.3.3676-18-4	360x760x1800	268
EMP.T.3.3691-18-4	360x910x1800	288
EMP.T.3.36107-18-4	360x1070x1800	312
EMP.T.3.36122-18-4	360x1220x1800	332
EMP.T.3.36137-18-4	360x1370x1800	352
EMP.T.3.36152-18-4	360x1520x1800	392
EMP.T.3.36183-18-4	360x1830x1800	440

INOX 201

Kod Code	Ebatlar Dimension mm	Fiyati Price Euro
EMP.T.2.3676-18-4	360x760x1800	200
EMP.T.2.3691-18-4	360x910x1800	212
EMP.T.2.36107-18-4	360x1070x1800	228
EMP.T.2.36122-18-4	360x1220x1800	240
EMP.T.2.36137-18-4	360x1370x1800	256
EMP.T.2.36152-18-4	360x1520x1800	284
EMP.T.2.36183-18-4	360x1830x1800	312

Kod Code	Ebatlar Dimension mm	Fiyati Price Euro
EMP.T.3.4676-18-4	460x760x1800	288
EMP.T.3.4691-18-4	460x910x1800	312
EMP.T.3.46107-18-4	460x1070x1800	336
EMP.T.3.46122-18-4	460x1220x1800	356
EMP.T.3.46137-18-4	460x1370x1800	400
EMP.T.3.46152-18-4	460x1520x1800	428
EMP.T.3.46183-18-4	460x1830x1800	476

Kod Code	Ebatlar Dimension mm	Fiyati Price Euro
EMP.T.2.4676-18-4	460x760x1800	224
EMP.T.2.4691-18-4	460x910x1800	240
EMP.T.2.46107-18-4	460x1070x1800	248
EMP.T.2.46122-18-4	460x1220x1800	260
EMP.T.2.46137-18-4	460x1370x1800	288
EMP.T.2.46152-18-4	460x1520x1800	304
EMP.T.2.46183-18-4	460x1830x1800	340



Tel Raflar 4 Katlı (1800 mm)
Wire Shelves With 4 Floor (1800 mm)

INOX 304

Kod Code	Ebatlar Dimension mm	Fiyatı Price Euro
EMP.T.3.5376-18-4	530x760x1800	296
EMP.T.3.5391-18-4	530x910x1800	324
EMP.T.3.53107-18-4	530x1070x1800	356
EMP.T.3.53122-18-4	530x1220x1800	416
EMP.T.3.53137-18-4	530x1370x1800	444
EMP.T.3.53152-18-4	530x1520x1800	468
EMP.T.3.53183-18-4	530x1830x1800	528

INOX 201

Kod Code	Ebatlar Dimension mm	Fiyatı Price Euro
EMP.T.2.5376-18-4	530x760x1800	228
EMP.T.2.5391-18-4	530x910x1800	244
EMP.T.2.53107-18-4	530x1070x1800	256
EMP.T.2.53122-18-4	530x1220x1800	300
EMP.T.2.53137-18-4	530x1370x1800	324
EMP.T.2.53152-18-4	530x1520x1800	340
EMP.T.2.53183-18-4	530x1830x1800	384

Kod Code	Ebatlar Dimension mm	Fiyatı Price Euro
EMP.T.3.6176-18-4	610x760x1800	316
EMP.T.3.6191-18-4	610x910x1800	356
EMP.T.3.61107-18-4	610x1070x1800	400
EMP.T.3.61122-18-4	610x1220x1800	432
EMP.T.3.61137-18-4	610x1370x1800	468
EMP.T.3.61152-18-4	610x1520x1800	504
EMP.T.3.61183-18-4	610x1830x1800	548

Kod Code	Ebatlar Dimension mm	Fiyatı Price Euro
EMP.T.2.6176-18-4	610x760x1800	240
EMP.T.2.6191-18-4	610x910x1800	268
EMP.T.2.61107-18-4	610x1070x1800	292
EMP.T.2.61122-18-4	610x1220x1800	324
EMP.T.2.61137-18-4	610x1370x1800	344
EMP.T.2.61152-18-4	610x1520x1800	368
EMP.T.2.61183-18-4	610x1830x1800	400



Düz Raflar
Smooth Shelves



INOX 304

Kod Code	Ebatlar Dimension mm	Fiyatı Price Euro
EMP.D.3.3676	360x760	55
EMP.D.3.3691	360x910	62
EMP.D.3.36107	360x1070	70
EMP.D.3.36122	360x1220	78
EMP.D.3.36137	360x1370	85
EMP.D.3.36152	360x1520	93
EMP.D.3.36183	360x1830	108

INOX 201

Kod Code	Ebatlar Dimension mm	Fiyatı Price Euro
EMP.D.2.3676	360x760	46
EMP.D.2.3691	360x910	52
EMP.D.2.36107	360x1070	59
EMP.D.2.36122	360x1220	64
EMP.D.2.36137	360x1370	70
EMP.D.2.36152	360x1520	76
EMP.D.2.36183	360x1830	88

Kod Code	Ebatlar Dimension mm	Fiyatı Price Euro
EMP.D.3.4676	460x760	61
EMP.D.3.4691	460x910	69
EMP.D.3.46107	460x1070	79
EMP.D.3.46122	460x1220	88
EMP.D.3.46137	460x1370	96
EMP.D.3.46152	460x1520	105
EMP.D.3.46183	460x1830	123

Kod Code	Ebatlar Dimension mm	Fiyatı Price Euro
EMP.D.2.4676	460x760	51
EMP.D.2.4691	460x910	58
EMP.D.2.46107	460x1070	65
EMP.D.2.46122	460x1220	72
EMP.D.2.46137	460x1370	79
EMP.D.2.46152	460x1520	86
EMP.D.2.46183	460x1830	100

INOX 304

Kod Code	Ebatlar Dimension mm	Fiyatı Price Euro
EMP.1600-3	1600	29
EMP.1800-3	1800	32
EMP.1600-3-H	1600	45
EMP.1800-3-H	1800	49

INOX 201

Kod Code	Ebatlar Dimension mm	Fiyatı Price Euro
EMP.1600-2	1600	23
EMP.1800-2	1800	24
EMP.1600-2-H	1600	39
EMP.1800-2-H	1800	41



EMP.1600-3 EMP.1800-3-H

Düz Raflar
Smooth Shelves



INOX 304

Kod Code	Ebatlar Dimension mm	Fiyatı Price Euro
EMP.D.3.5376	530x760	66
EMP.D.3.5391	530x910	75
EMP.D.3.53107	530x1070	85
EMP.D.3.53122	530x1220	94
EMP.D.3.53137	530x1370	104
EMP.D.3.53152	530x1520	113
EMP.D.3.53183	530x1830	133

INOX 201

Kod Code	Ebatlar Dimension mm	Fiyatı Price Euro
EMP.D.2.5376	530x760	55
EMP.D.2.5391	530x910	62
EMP.D.2.53107	530x1070	70
EMP.D.2.53122	530x1220	78
EMP.D.2.53137	530x1370	85
EMP.D.2.53152	530x1520	93
EMP.D.2.53183	530x1830	108

Kod Code	Ebatlar Dimension mm	Fiyatı Price Euro
EMP.D.3.6176	610x760	70
EMP.D.3.6191	610x910	81
EMP.D.3.61107	610x1070	92
EMP.D.3.61122	610x1220	102
EMP.D.3.61137	610x1370	112
EMP.D.3.61152	610x1520	123
EMP.D.3.61183	610x1830	145

Kod Code	Ebatlar Dimension mm	Fiyatı Price Euro
EMP.D.2.6176	610x760	59
EMP.D.2.6191	610x910	67
EMP.D.2.61107	610x1070	75
EMP.D.2.61122	610x1220	83
EMP.D.2.61137	610x1370	92
EMP.D.2.61152	610x1520	100
EMP.D.2.61183	610x1830	117

Düz Raflar 4 Katlı (1600 mm)
Smooth Shelves With 4 Floor (1600 mm)



INOX 304

Kod Code	Ebatlar Dimension mm	Fiyatı Price Euro
EMP.D.3.3676-16-4	360x760x1600	334
EMP.D.3.3691-16-4	360x910x1600	364
EMP.D.3.36107-16-4	360x1070x1600	397
EMP.D.3.36122-16-4	360x1220x1600	427
EMP.D.3.36137-16-4	360x1370x1600	456
EMP.D.3.36152-16-4	360x1520x1600	486
EMP.D.3.36183-16-4	360x1830x1600	549

INOX 201

Kod Code	Ebatlar Dimension mm	Fiyatı Price Euro
EMP.D.2.3676-16-4	360x760x1600	277
EMP.D.2.3691-16-4	360x910x1600	300
EMP.D.2.36107-16-4	360x1070x1600	327
EMP.D.2.36122-16-4	360x1220x1600	350
EMP.D.2.36137-16-4	360x1370x1600	373
EMP.D.2.36152-16-4	360x1520x1600	396
EMP.D.2.36183-16-4	360x1830x1600	446

Kod Code	Ebatlar Dimension mm	Fiyatı Price Euro
EMP.D.3.4676-16-4	460x760x1600	361
EMP.D.3.4691-16-4	460x910x1600	394
EMP.D.3.46107-16-4	460x1070x1600	430
EMP.D.3.46122-16-4	460x1220x1600	466
EMP.D.3.46137-16-4	460x1370x1600	499
EMP.D.3.46152-16-4	460x1520x1600	536
EMP.D.3.46183-16-4	460x1830x1600	609

Kod Code	Ebatlar Dimension mm	Fiyatı Price Euro
EMP.D.2.4676-16-4	460x760x1600	297
EMP.D.2.4691-16-4	460x910x1600	323
EMP.D.2.46107-16-4	460x1070x1600	353
EMP.D.2.46122-16-4	460x1220x1600	380
EMP.D.2.46137-16-4	460x1370x1600	409
EMP.D.2.46152-16-4	460x1520x1600	436
EMP.D.2.46183-16-4	460x1830x1600	492



Düz Raflar 4 Katlı (1600 mm)
Smooth Shelves With 4 Floor (1600 mm)

INOX 304

Kod Code	Ebatlar Dimension mm	Fiyatı Price Euro
EMP.D.3.5376-16-4	530x760x1600	380
EMP.D.3.5391-16-4	530x910x1600	417
EMP.D.3.53107-16-4	530x1070x1600	456
EMP.D.3.53122-16-4	530x1220x1600	493
EMP.D.3.53137-16-4	530x1370x1600	533
EMP.D.3.53152-16-4	530x1520x1600	569
EMP.D.3.53183-16-4	530x1830x1600	648

INOX 201

Kod Code	Ebatlar Dimension mm	Fiyatı Price Euro
EMP.D.2.5376-16-4	530x760x1600	310
EMP.D.2.5391-16-4	530x910x1600	340
EMP.D.2.53107-16-4	530x1070x1600	373
EMP.D.2.53122-16-4	530x1220x1600	403
EMP.D.2.53137-16-4	530x1370x1600	432
EMP.D.2.53152-16-4	530x1520x1600	462
EMP.D.2.53183-16-4	530x1830x1600	525

Kod Code	Ebatlar Dimension mm	Fiyatı Price Euro
EMP.D.3.6176-16-4	610x760x1600	397
EMP.D.3.6191-16-4	610x910x1600	440
EMP.D.3.61107-16-4	610x1070x1600	483
EMP.D.3.61122-16-4	610x1220x1600	526
EMP.D.3.61137-16-4	610x1370x1600	566
EMP.D.3.61152-16-4	610x1520x1600	609
EMP.D.3.61183-16-4	610x1830x1600	694

Kod Code	Ebatlar Dimension mm	Fiyatı Price Euro
EMP.D.2.6176-16-4	610x760x1600	327
EMP.D.2.6191-16-4	610x910x1600	360
EMP.D.2.61107-16-4	610x1070x1600	393
EMP.D.2.61122-16-4	610x1220x1600	426
EMP.D.2.61137-16-4	610x1370x1600	459
EMP.D.2.61152-16-4	610x1520x1600	492
EMP.D.2.61183-16-4	610x1830x1600	561



Düz Raflar 4 Katlı (1800 mm)
Smooth Shelves With 4 Floor (1800 mm)



INOX 304

Kod Code	Ebatlar Dimension mm	Fiyatı Price Euro
EMP.D.3.3676-18-4	360x760x1800	346
EMP.D.3.3691-18-4	360x910x1800	376
EMP.D.3.36107-18-4	360x1070x1800	409
EMP.D.3.36122-18-4	360x1220x1800	439
EMP.D.3.36137-18-4	360x1370x1800	468
EMP.D.3.36152-18-4	360x1520x1800	498
EMP.D.3.36183-18-4	360x1830x1800	561

INOX 201

Kod Code	Ebatlar Dimension mm	Fiyatı Price Euro
EMP.D.2.3676-18-4	360x760x1800	280
EMP.D.2.3691-18-4	360x910x1800	304
EMP.D.2.36107-18-4	360x1070x1800	332
EMP.D.2.36122-18-4	360x1220x1800	352
EMP.D.2.36137-18-4	360x1370x1800	376
EMP.D.2.36152-18-4	360x1520x1800	400
EMP.D.2.36183-18-4	360x1830x1800	448

Kod Code	Ebatlar Dimension mm	Fiyatı Price Euro
EMP.D.3.4676-18-4	460x760x1800	373
EMP.D.3.4691-18-4	460x910x1800	406
EMP.D.3.46107-18-4	460x1070x1800	442
EMP.D.3.46122-18-4	460x1220x1800	480
EMP.D.3.46137-18-4	460x1370x1800	511
EMP.D.3.46152-18-4	460x1520x1800	548
EMP.D.3.46183-18-4	460x1830x1800	621

Kod Code	Ebatlar Dimension mm	Fiyatı Price Euro
EMP.D.2.4676-18-4	460x760x1800	300
EMP.D.2.4691-18-4	460x910x1800	328
EMP.D.2.46107-18-4	460x1070x1800	356
EMP.D.2.46122-18-4	460x1220x1800	384
EMP.D.2.46137-18-4	460x1370x1800	412
EMP.D.2.46152-18-4	460x1520x1800	440
EMP.D.2.46183-18-4	460x1830x1800	496



Düz Raflar 4 Katlı (1800 mm)
Smooth Shelves With 4 Floor (1800 mm)



INOX 304

Kod Code	Ebatlar Dimension mm	Fiyatı Price Euro
EMP.D.3.5376-18-4	530x760x1800	392
EMP.D.3.5391-18-4	530x910x1800	429
EMP.D.3.53107-18-4	530x1070x1800	468
EMP.D.3.53122-18-4	530x1220x1800	505
EMP.D.3.53137-18-4	530x1370x1800	545
EMP.D.3.53152-18-4	530x1520x1800	581
EMP.D.3.53183-18-4	530x1830x1800	660

INOX 201

Kod Code	Ebatlar Dimension mm	Fiyatı Price Euro
EMP.D.2.5376-18-4	530x760x1800	316
EMP.D.2.5391-18-4	530x910x1800	344
EMP.D.2.53107-18-4	530x1070x1800	376
EMP.D.2.53122-18-4	530x1220x1800	408
EMP.D.2.53137-18-4	530x1370x1800	436
EMP.D.2.53152-18-4	530x1520x1800	468
EMP.D.2.53183-18-4	530x1830x1800	528

Kod Code	Ebatlar Dimension mm	Fiyatı Price Euro
EMP.D.3.6176-18-4	610x760x1800	409
EMP.D.3.6191-18-4	610x910x1800	452
EMP.D.3.61107-18-4	610x1070x1800	495
EMP.D.3.61122-18-4	610x1220x1800	538
EMP.D.3.61137-18-4	610x1370x1800	578
EMP.D.3.61152-18-4	610x1520x1800	621
EMP.D.3.61183-18-4	610x1830x1800	706

Kod Code	Ebatlar Dimension mm	Fiyatı Price Euro
EMP.D.2.6176-18-4	610x760x1800	332
EMP.D.2.6191-18-4	610x910x1800	364
EMP.D.2.61107-18-4	610x1070x1800	396
EMP.D.2.61122-18-4	610x1220x1800	428
EMP.D.2.61137-18-4	610x1370x1800	464
EMP.D.2.61152-18-4	610x1520x1800	496
EMP.D.2.61183-18-4	610x1830x1800	564



Delikli Raflar
Perforated Shelves

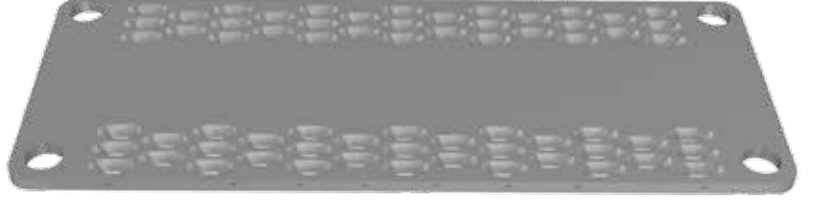

INOX 304

Kod Code	Ebatlar Dimension mm	Fiyatı Price Euro
EMP.D.3.3676-D	360x760	59
EMP.D.3.3691-D	360x910	67
EMP.D.3.36107-D	360x1070	76
EMP.D.3.36122-D	360x1220	84
EMP.D.3.36137-D	360x1370	92
EMP.D.3.36152-D	360x1520	100
EMP.D.3.36183-D	360x1830	117

INOX 201

Kod Code	Ebatlar Dimension mm	Fiyatı Price Euro
EMP.D.2.3676-D	360x760	50
EMP.D.2.3691-D	360x910	56
EMP.D.2.36107-D	360x1070	63
EMP.D.2.36122-D	360x1220	70
EMP.D.2.36137-D	360x1370	76
EMP.D.2.36152-D	360x1520	82
EMP.D.2.36183-D	360x1830	96

Kod Code	Ebatlar Dimension mm	Fiyatı Price Euro
EMP.D.3.4676-D	460x760	66
EMP.D.3.4691-D	460x910	75
EMP.D.3.46107-D	460x1070	85
EMP.D.3.46122-D	460x1220	95
EMP.D.3.46137-D	460x1370	104
EMP.D.3.46152-D	460x1520	114
EMP.D.3.46183-D	460x1830	133

Kod Code	Ebatlar Dimension mm	Fiyatı Price Euro
EMP.D.2.4676-D	460x760	55
EMP.D.2.4691-D	460x910	63
EMP.D.2.46107-D	460x1070	71
EMP.D.2.46122-D	460x1220	78
EMP.D.2.46137-D	460x1370	86
EMP.D.2.46152-D	460x1520	93
EMP.D.2.46183-D	460x1830	108

INOX 304

Kod Code	Ebatlar Dimension mm	Fiyatı Price Euro
EMP.1600-3	1600	29
EMP.1800-3	1800	32
EMP.1600-3-H	1600	45
EMP.1800-3-H	1800	49

INOX 201

Kod Code	Ebatlar Dimension mm	Fiyatı Price Euro
EMP.1600-2	1600	23
EMP.1800-2	1800	24
EMP.1600-2-H	1600	39
EMP.1800-2-H	1800	41

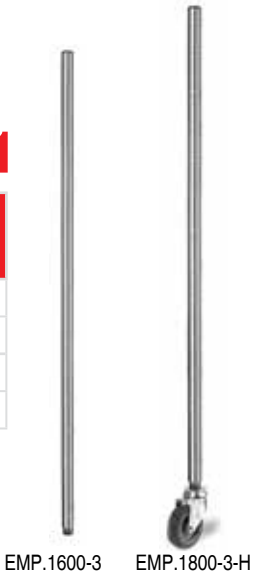

EMP.1600-3 EMP.1800-3-H

Delikli Raflar
Perforated Shelves



INOX 304

Kod Code	Ebatlar Dimension mm	Fiyatı Price Euro
EMP.D.3.5376-D	530x760	72
EMP.D.3.5391-D	530x910	81
EMP.D.3.53107-D	530x1070	92
EMP.D.3.53122-D	530x1220	102
EMP.D.3.53137-D	530x1370	113
EMP.D.3.53152-D	530x1520	122
EMP.D.3.53183-D	530x1830	144

INOX 201

Kod Code	Ebatlar Dimension mm	Fiyatı Price Euro
EMP.D.2.5376-D	530x760	59
EMP.D.2.5391-D	530x910	67
EMP.D.2.53107-D	530x1070	76
EMP.D.2.53122-D	530x1220	84
EMP.D.2.53137-D	530x1370	92
EMP.D.2.53152-D	530x1520	100
EMP.D.2.53183-D	530x1830	117

Kod Code	Ebatlar Dimension mm	Fiyatı Price Euro
EMP.D.3.6176-D	610x760	76
EMP.D.3.6191-D	610x910	88
EMP.D.3.61107-D	610x1070	99
EMP.D.3.61122-D	610x1220	111
EMP.D.3.61137-D	610x1370	122
EMP.D.3.61152-D	610x1520	133
EMP.D.3.61183-D	610x1830	156

Kod Code	Ebatlar Dimension mm	Fiyatı Price Euro
EMP.D.2.6176-D	610x760	63
EMP.D.2.6191-D	610x910	72
EMP.D.2.61107-D	610x1070	81
EMP.D.2.61122-D	610x1220	90
EMP.D.2.61137-D	610x1370	99
EMP.D.2.61152-D	610x1520	108
EMP.D.2.61183-D	610x1830	127

Delikli Raflar 4 Katlı (1600 mm)
Perforated Shelves With 4 Floor (1600 mm)



INOX 304

Kod Code	Ebatlar Dimension mm	Fiyatı Price Euro
EMP.D.3.3676-16-4-D	360x760x1600	352
EMP.D.3.3691-16-4-D	360x910x1600	384
EMP.D.3.36107-16-4-D	360x1070x1600	420
EMP.D.3.36122-16-4-D	360x1220x1600	452
EMP.D.3.36137-16-4-D	360x1370x1600	484
EMP.D.3.36152-16-4-D	360x1520x1600	516
EMP.D.3.36183-16-4-D	360x1830x1600	584

INOX 201

Kod Code	Ebatlar Dimension mm	Fiyatı Price Euro
EMP.D.2.3676-16-4-D	360x760x1600	292
EMP.D.2.3691-16-4-D	360x910x1600	317
EMP.D.2.36107-16-4-D	360x1070x1600	346
EMP.D.2.36122-16-4-D	360x1220x1600	371
EMP.D.2.36137-16-4-D	360x1370x1600	396
EMP.D.2.36152-16-4-D	360x1520x1600	421
EMP.D.2.36183-16-4-D	360x1830x1600	475

Kod Code	Ebatlar Dimension mm	Fiyatı Price Euro
EMP.D.3.4676-16-4-D	460x760x1600	381
EMP.D.3.4691-16-4-D	460x910x1600	416
EMP.D.3.46107-16-4-D	460x1070x1600	456
EMP.D.3.46122-16-4-D	460x1220x1600	495
EMP.D.3.46137-16-4-D	460x1370x1600	531
EMP.D.3.46152-16-4-D	460x1520x1600	570
EMP.D.3.46183-16-4-D	460x1830x1600	649

Kod Code	Ebatlar Dimension mm	Fiyatı Price Euro
EMP.D.2.4676-16-4-D	460x760x1600	314
EMP.D.2.4691-16-4-D	460x910x1600	342
EMP.D.2.46107-16-4-D	460x1070x1600	374
EMP.D.2.46122-16-4-D	460x1220x1600	403
EMP.D.2.46137-16-4-D	460x1370x1600	435
EMP.D.2.46152-16-4-D	460x1520x1600	464
Ev MP.D.2.46183-16-4-D	460x1830x1600	525



Delikli Raflar 4 Katlı (1600 mm)
Perforated Shelves With 4 Floor (1600 mm)

INOX 304

Kod Code	Ebatlar Dimension mm	Fiyatı Price Euro
EMP.D.3.5376-16-4-D	530x760x1600	402
EMP.D.3.5391-16-4-D	530x910x1600	441
EMP.D.3.53107-16-4-D	530x1070x1600	484
EMP.D.3.53122-16-4-D	530x1220x1600	524
EMP.D.3.53137-16-4-D	530x1370x1600	566
EMP.D.3.53152-16-4-D	530x1520x1600	606
EMP.D.3.53183-16-4-D	530x1830x1600	692

INOX 201

Kod Code	Ebatlar Dimension mm	Fiyatı Price Euro
EMP.D.2.5376-16-4-D	530x760x1600	328
EMP.D.2.5391-16-4-D	530x910x1600	360
EMP.D.2.53107-16-4-D	530x1070x1600	396
EMP.D.2.53122-16-4-D	530x1220x1600	428
EMP.D.2.53137-16-4-D	530x1370x1600	460
EMP.D.2.53152-16-4-D	530x1520x1600	492
EMP.D.2.53183-16-4-D	530x1830x1600	560

Kod Code	Ebatlar Dimension mm	Fiyatı Price Euro
EMP.D.3.6176-16-4-D	610x760x1600	420
EMP.D.3.6191-16-4-D	610x910x1600	466
EMP.D.3.61107-16-4-D	610x1070x1600	513
EMP.D.3.61122-16-4-D	610x1220x1600	559
EMP.D.3.61137-16-4-D	610x1370x1600	602
EMP.D.3.61152-16-4-D	610x1520x1600	649
EMP.D.3.61183-16-4-D	610x1830x1600	742

Kod Code	Ebatlar Dimension mm	Fiyatı Price Euro
EMP.D.2.6176-16-4-D	610x760x1600	346
EMP.D.2.6191-16-4-D	610x910x1600	382
EMP.D.2.61107-16-4-D	610x1070x1600	417
EMP.D.2.61122-16-4-D	610x1220x1600	453
EMP.D.2.61137-16-4-D	610x1370x1600	489
EMP.D.2.61152-16-4-D	610x1520x1600	525
EMP.D.2.61183-16-4-D	610x1830x1600	600



Delikli Raflar 4 Katlı (1800 mm)
Perforated Shelves With 4 Floor (1800 mm)



INOX 304

Kod Code	Ebatlar Dimension mm	Fiyatı Price Euro
EMP.D.3.3676-18-4-D	360x760x1800	364
EMP.D.3.3691-18-4-D	360x910x1800	396
EMP.D.3.36107-18-4-D	360x1070x1800	432
EMP.D.3.36122-18-4-D	360x1220x1800	464
EMP.D.3.36137-18-4-D	360x1370x1800	496
EMP.D.3.36152-18-4-D	360x1520x1800	528
EMP.D.3.36183-18-4-D	360x1830x1800	596

INOX 201

Kod Code	Ebatlar Dimension mm	Fiyatı Price Euro
EMP.D.2.3676-18-4-D	360x760x1800	296
EMP.D.2.3691-18-4-D	360x910x1800	321
EMP.D.2.36107-18-4-D	360x1070x1800	350
EMP.D.2.36122-18-4-D	360x1220x1800	375
EMP.D.2.36137-18-4-D	360x1370x1800	400
EMP.D.2.36152-18-4-D	360x1520x1800	425
EMP.D.2.36183-18-4-D	360x1830x1800	479

Kod Code	Ebatlar Dimension mm	Fiyatı Price Euro
EMP.D.3.4676-18-4-D	460x760x1800	393
EMP.D.3.4691-18-4-D	460x910x1800	428
EMP.D.3.46107-18-4-D	460x1070x1800	468
EMP.D.3.46122-18-4-D	460x1220x1800	507
EMP.D.3.46137-18-4-D	460x1370x1800	543
EMP.D.3.46152-18-4-D	460x1520x1800	582
EMP.D.3.46183-18-4-D	460x1830x1800	661

Kod Code	Ebatlar Dimension mm	Fiyatı Price Euro
EMP.D.2.4676-18-4-D	460x760x1800	318
EMP.D.2.4691-18-4-D	460x910x1800	346
EMP.D.2.46107-18-4-D	460x1070x1800	378
EMP.D.2.46122-18-4-D	460x1220x1800	407
EMP.D.2.46137-18-4-D	460x1370x1800	439
EMP.D.2.46152-18-4-D	460x1520x1800	468
EMP.D.2.46183-18-4-D	460x1830x1800	529



Delikli Raflar 4 Katlı (1800 mm)
Perforated Shelves With 4 Floor (1800 mm)

INOX 304

Kod Code	Ebatlar Dimension mm	Fiyatı Price Euro
EMP.D.3.5376-18-4-D	530x760x1800	414
EMP.D.3.5391-18-4-D	530x910x1800	453
EMP.D.3.53107-18-4-D	530x1070x1800	496
EMP.D.3.53122-18-4-D	530x1220x1800	536
EMP.D.3.53137-18-4-D	530x1370x1800	578
EMP.D.3.53152-18-4-D	530x1520x1800	618
EMP.D.3.53183-18-4-D	530x1830x1800	704

INOX 201

Kod Code	Ebatlar Dimension mm	Fiyatı Price Euro
EMP.D.2.5376-18-4-D	530x760x1800	332
EMP.D.2.5391-18-4-D	530x910x1800	364
EMP.D.2.53107-18-4-D	530x1070x1800	400
EMP.D.2.53122-18-4-D	530x1220x1800	432
EMP.D.2.53137-18-4-D	530x1370x1800	464
EMP.D.2.53152-18-4-D	530x1520x1800	496
EMP.D.2.53183-18-4-D	530x1830x1800	564

Kod Code	Ebatlar Dimension mm	Fiyatı Price Euro
EMP.D.3.6176-18-4-D	610x760x1800	432
EMP.D.3.6191-18-4-D	610x910x1800	478
EMP.D.3.61107-18-4-D	610x1070x1800	525
EMP.D.3.61122-18-4-D	610x1220x1800	571
EMP.D.3.61137-18-4-D	610x1370x1800	614
EMP.D.3.61152-18-4-D	610x1520x1800	661
EMP.D.3.61183-18-4-D	610x1830x1800	754

Kod Code	Ebatlar Dimension mm	Fiyatı Price Euro
EMP.D.2.6176-18-4-D	610x760x1800	350
EMP.D.2.6191-18-4-D	610x910x1800	386
EMP.D.2.61107-18-4-D	610x1070x1800	421
EMP.D.2.61122-18-4-D	610x1220x1800	457
EMP.D.2.61137-18-4-D	610x1370x1800	493
EMP.D.2.61152-18-4-D	610x1520x1800	529
EMP.D.2.61183-18-4-D	610x1830x1800	604



Mutfak Bulaşık Arabaları
Soiled Dish Trolleys

DEMONTE

Stainless Steel / Paslanmaz Çelik

Kod Code	Ürün Adı Product Name	Ebatlar Dimension mm	Kapasite Capacity Tepsi/Tray	Fiyatı Price Euro
EMP.BA.2.3753-13	Bulaşık Toplama , Selfrom 37x53 Tekli Tray Trolley, With Rails-Single Row, For 37x53	430x560x1710	13-15	300
EMP.BA.2.3753-26	Bulaşık Toplama , Selfrom 37x53 İkili Tray Trolley, With Rails-Twin Row, For 37x53	830x560x1710	26-30	485
EMP.BA.2.3753-39	Bulaşık Toplama , Selfrom 37x53 Üçlü Tray Trolley, With Rails-Triple Row, For 37x53	1230x560x1710	39-45	675

Bardak tepsili / With glass tray on top

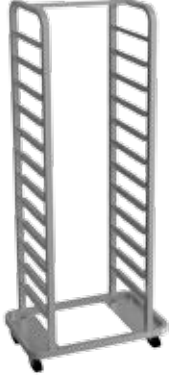

Kod Code	Ürün Adı Product Name	Ebatlar Dimension mm	Kapasite Capacity Gn 1/1	Fiyatı Price Euro
EMP.BA.2.GN-9	Tepsi Taşıma Alçak- Tekli Gn 1/1 Gn Trolley Low-Single Gn 1/1	380x560x1050	9	200
EMP.BA.2.GN-17	Tepsi Taşıma Yüksek- Tekli Gn 1/1 Gn Trolley High-Single Gn 1/1	380x560x1720	17	255
EMP.BA.2.GN-34	Tepsi Taşıma Yüksek-İkili Gn 1/1 Gn Trolley High-Twin Gn 1/1	740x560x1720	34	420



Kod Code	Ürün Adı Product Name	Ebatlar Dimension mm	Kapasite Capacity Gn 2/1	Fiyatı Price Euro
EMP.BA.2.GN2-9	Tepsi Taşıma Alçak- Tekli Gn 2/1 Gn Trolley Low-Single Gn 2/1	590x680x1050	9	240
EMP.BA.2.GN2-17	Tepsi Taşıma Yüksek- Tekli Gn 2/1 Gn Trolley High-Single Gn 2/1	590x680x1720	17	300
EMP.BA.2.GN2-34	Tepsi Taşıma Yüksek-İkili Gn 2/1 Gn Trolley High-Twin Gn 2/1	1150x680x1720	34	475

304 Kalite istenirse fiyata %20 ilave ediniz
%20 add on list price for 304 quality

Mutfak Bulaşık Arabaları
Soiled Dish Trolleys

Stainless Steel / Paslanmaz Çelik

DEMONTE



Kod Code	Ürün Adı Product Name	Ebatlar Dimension mm	Kapasite Capacity Tepsi/Tray	Fiyatı Price Euro
EMP.TT.2.6040	Tepsi Taşıma- 60x40 Tepsiye Göre-Tekli Tray Trolley For 60x40 Tray-Single	460x630x1650	15	300
EMP.2TT.2.6040	Tepsi Taşıma, 60x40 Tepsiye Göre-Ikili Tray Trolley For 60x40 Tray-Twin	900x630x1650	30	535



Kod Code	Ürün Adı Product Name	Ebatlar Dimension mm	Fiyatı Price Euro
EMP.TT.2.7050	Tepsi Taşıma-70x50 Tepsiye Göre Tray Trolley For 70x50 Tray	560x730x1700	310



Kod Code	Ürün Adı Product Name	Ebatlar Dimension mm	Fiyatı Price Euro
EMP.BAKA.2.5	Kaset Taşıma-Alçak Basket Trolley With Rails-Low	560x530x900	170

5 Kaset, Kapasiteli / 5 Cassette Capacity
Kasetler Hariçtir / Excluding tapes



Kod Code	Ürün Adı Product Name	Ebatlar Dimension mm	Fiyatı Price Euro
EMP.BAKY.2.10	Kaset Taşıma-Yüksek Basket Trolley With-High	560x530x1650	250

10 Kaset, Kapasiteli / 10 Cassette Capacity

304 Kalite istenirse fiyata %20 ilave ediniz
%20 add on list price for 304 quality

Servis Arabaları
Service Trolleys

DEMONTE

Stainless Steel / Paslanmaz Çelik

Kod Code	Ürün Adı Product Name	Ebatlar Dimension mm	Fiyatı Price Euro
EMP.BAH.2.8555-90	Bulaşık Toplama-Havuzlu Tray Clearing Trolley	850x550x900	230



Kod Code	Ürün Adı Product Name	Ebatlar Dimension mm	Fiyatı Price Euro
EMP.2.SV.02	Servis-İki Katlı Service Trolley, 2 Tiers	550x860x900	190



Pres baskılı tabla / Pressed stainless steel table

Kod Code	Ürün Adı Product Name	Ebatlar Dimension mm	Fiyatı Price Euro
EMP.2.SV.03	Servis-Üç Katlı Service Trolley, 3 Tiers	550x860x900	230



Pres baskılı tabla / Pressed stainless steel table

Kod Code	Ürün Adı Product Name	Ebatlar Dimension mm	Fiyatı Price Euro
EMP.BAKT.2.5555-90	Kaset Taşıma-Kollu Basket Trolley With Handle	550x550x900	112



304 Kalite istenirse fiyata %20 ilave ediniz
%20 add on list price for 304 quality

Taşıma ve Muhafaza Arabaları
Mobile Storage Bins and Transport Carts

Stainless Steel / Paslanmaz Çelik

Kod Code	Ürün Adı Product Name	Ebatlar Dimension mm	Fiyatı Price Euro
EMP. BAKTT.2.906050-90	Kazan-Tencere Taşıma Boiler, Cooker Transport	900x600x500/900	250

Platform Yüksek / Platform Trolley High



Kod Code	Ürün Adı Product Name	Ebatlar Dimension mm	Fiyatı Price Euro
EMP.TA.2.1055-17	Et Askı Arabası Carcass Hanger	1000x550x1700	395
EMP.TA.2.1255-17	Et Askı Arabası Carcass Hanger	1200x550x1700	430
EMP.TA.2.1555-17	Et Askı Arabası Carcass Hanger	1500x550x1700	460



Kod Code	Ürün Adı Product Name	Ebatlar Dimension mm	Fiyatı Price Euro
EMP.PD.2.806020-90	Platform-Düz Platform Trolley, Solid	800x600x200 / 900	240

Kasetler Hariçtir / Baskets not included

Taşıma ve Muhafaza Arabaları

Mobile Storage Bins and Transport Carts

Kod Code	Ürün Adı Product Name	Ebatlar Dimension mm	Tipi Type	Fiyatı Price Euro
EMP.CY.01	Çöp Yuvarlak Mobile Waste Bin-Round	Ø 400x400	INOX 304	160

Pres Baskı / Pressed



Kod Code	Ürün Adı Product Name	Ebatlar Dimension mm	Tipi Type	Fiyatı Price Euro
EMP.CK.01	Çöp Kare Mobile Waste Bin, Square	500x550x500	INOX 304	250

Pres Baskı / Pressed



Kod Code	Ürün Adı Product Name	Ebatlar Dimension mm	Tipi Type	Fiyatı Price Euro
EMP.ECK.3.8454-58	Erzak-Çift Kapaklı Mobile Bin Double Lid	840x540x580	INOX 304	340

Pres Baskı / Pressed



Tabak Otomatları
Plate Dispensers

Kod Code	Ürün Adı Product Name	Ebatlar Dimension mm	Fiyatı Price Euro
EMP.TO.1826-N-1	Tabak Otomatı Tekli - 18 / 26 Plate Dispenser - Single	Nötr 440x500x900	350
EMP.TO.1826-I-1	Tabak Otomatı Tekli - 18 / 26 Plate Dispenser - Single	Isıtmalı 440x500x900	390
EMP.TO.2432-N-1	Tabak Otomatı Tekli - 24 / 32 Plate Dispenser - Single	Nötr 480x550x900	395
EMP.TO.2432-I-1	Tabak Otomatı Tekli - 24 / 32 Plate Dispenser - Single	Isıtmalı 480x550x900	435

Tabaklar hariçtir / Plates not included



Kod Code	Ürün Adı Product Name	Ebatlar Dimension mm	Fiyatı Price Euro
EMP.TO.1826-N-2	Tabak Otomatı İkili - 18 / 26 Plate Dispenser - Double	Nötr 440x880x900	575
EMP.TO.1826-I-2	Tabak Otomatı İkili - 18 / 26 Plate Dispenser - Double	Isıtmalı 440x880x900	665
EMP.TO.2432-N-2	Tabak Otomatı İkili - 24 / 32 Plate Dispenser - Double	Nötr 480x1000x900	630
EMP.TO.2432-I-2	Tabak Otomatı İkili - 24 / 32 Plate Dispenser - Double	Isıtmalı 480x1000x900	710

Tabaklar hariçtir / Plates not included



Kod Code	Ürün Adı Product Name	Ebatlar Dimension mm	Fiyatı Price Euro
EMP.TO.1826-N	Tabak Kartuşu - 18 / 26 Plate Dispensing Cartridge	Nötr 380x380x750	175
EMP.TO.1826-I	Tabak Kartuşu - 18 / 26 Plate Dispensing Cartridge	Isıtmalı 380x380x750	215
EMP.TO.2432-N	Tabak Kartuşu - 24 / 32 Plate Dispensing Cartridge	Nötr 440x440x750	195
EMP.TO.2432-I	Tabak Kartuşu - 24 / 32 Plate Dispensing Cartridge	Isıtmalı 440x440x750	230

Tabaklar hariçtir / Plates not included

Yer Filtreleri Alttan Çıkışlı Floor Filters Bottom Outlet



Kod Code	Ürün Adı Product Name	Ebatlar Dimension mm	Fiyatı Price Euro
EMP.YF.AO.3030	Altan Çıkışlı Ortadan Sifonlu / Bottom Outlet Center Drain	300x300x150	125
EMP.YF.AO.3050	Altan Çıkışlı Ortadan Sifonlu / Bottom Outlet Center Drain	300x500x150	165
EMP.YF.AO.3074	Altan Çıkışlı Ortadan Sifonlu / Bottom Outlet Center Drain	300x740x150	200
EMP.YF.AO.3094	Altan Çıkışlı Ortadan Sifonlu / Bottom Outlet Center Drain	300x940x150	270
EMP.YF.AO.30118	Altan Çıkışlı Ortadan Sifonlu / Bottom Outlet Center Drain	300x1180x150	310
EMP.YF.AO.30138	Altan Çıkışlı Ortadan Sifonlu / Bottom Outlet Center Drain	300x1380x150	330
EMP.YF.AO.30161	Altan Çıkışlı Ortadan Sifonlu / Bottom Outlet Center Drain	300x1610x150	385
EMP.YF.AO.30181	Altan Çıkışlı Ortadan Sifonlu / Bottom Outlet Center Drain	300x1810x150	425
EMP.YF.AO.30205	Altan Çıkışlı Ortadan Sifonlu / Bottom Outlet Center Drain	300x2050x150	470
EMP.YF.AO.30225	Altan Çıkışlı Ortadan Sifonlu / Bottom Outlet Center Drain	300x2250x150	515
EMP.YF.AO.30249	Altan Çıkışlı Ortadan Sifonlu / Bottom Outlet Center Drain	300x2490x150	595

Çıkış çapı : 74mm
Outlet Diameter : 74mm



Yer Filtreleri Yandan Çıkışlı Floor Filters Side Outlet

Kod Code	Ürün Adı Product Name	Ebatlar Dimension mm	Fiyatı Price Euro
EMP.YF.YO.3030	Yandan Çıkışlı Ortadan Sifonlu / Side Outlet Center Drain	300x300x150	115
EMP.YF.YO.3050	Yandan Çıkışlı Ortadan Sifonlu / Side Outlet Center Drain	300x500x150	150
EMP.YF.YO.3074	Yandan Çıkışlı Ortadan Sifonlu / Side Outlet Center Drain	300x740x150	200
EMP.YF.YO.3094	Yandan Çıkışlı Ortadan Sifonlu / Side Outlet Center Drain	300x940x150	245
EMP.YF.YO.30118	Yandan Çıkışlı Ortadan Sifonlu / Side Outlet Center Drain	300x1180x150	285
EMP.YF.YO.30138	Yandan Çıkışlı Ortadan Sifonlu / Side Outlet Center Drain	300x1380x150	340
EMP.YF.YO.30161	Yandan Çıkışlı Ortadan Sifonlu / Side Outlet Center Drain	300x1610x150	385
EMP.YF.YO.30181	Yandan Çıkışlı Ortadan Sifonlu / Side Outlet Center Drain	300x1810x150	425
EMP.YF.YO.30205	Yandan Çıkışlı Ortadan Sifonlu / Side Outlet Center Drain	300x2050x150	445
EMP.YF.YO.30225	Yandan Çıkışlı Ortadan Sifonlu / Side Outlet Center Drain	300x2250x150	525
EMP.YF.YO.30249	Yandan Çıkışlı Ortadan Sifonlu / Side Outlet Center Drain	300x2490x150	565

Çıkış çapı : 74mm
Outlet Diameter : 74mm

Tel Izgaralar
Wire Grid



INOX 304

Kod Code	Ürün Adı Product Name	Ebatlar Dimension mm	Fiyatı Price Euro
EMP.3.530325	Tel Izgara GN 1/1 Wire Grid GN 1/1	530x325	12
EMP.3.650530	Tel Izgara GN 2/1 Wire Grid GN 2/1	650x530	23
EMP.3.600400	Tel Izgara Wire Grid	600x400	16

INOX 201

Kod Code	Ürün Adı Product Name	Ebatlar Dimension mm	Fiyatı Price Euro
EMP.2.530325	Tel Izgara GN 1/1 Wire Grid GN 1/1	530x325	9
EMP.2.650530	Tel Izgara GN 2/1 Wire Grid GN 2/1	650x530	15
EMP.2.600400	Tel Izgara Wire Grid	600x400	11

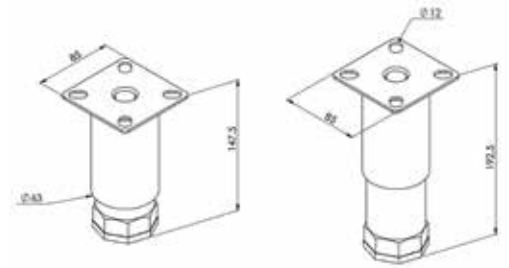

Boru Ayak / Foot

Kod Code	Ürün Adı Product Name	Ebatlar Dimension mm	Fiyatı Price Euro
EMP.BRA.150	Boru Ayak Foot	150	5

Davlumbaz Filtreleri Hood Filters

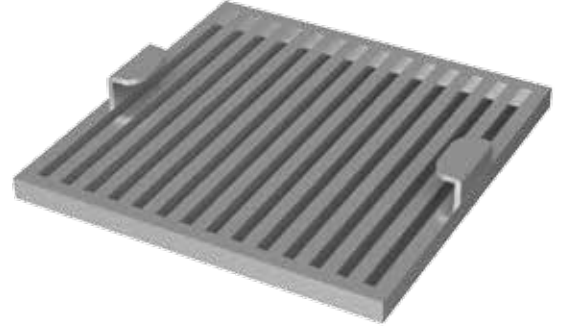

Kod Code	Ürün Adı Product Name	Ebatlar Dimension mm	Fiyatı Price Euro
EMP.4.55	Davlumbaz Fitesi Filter For Hood	500x500	24

430 Kalite parlak yüzey / AISI 430 Stainless Steel Polished



Yağ Ayırıcı Grease Seperator

Kod Code	Ürün Adı Product Name	Ebatlar Dimension mm	Ağırlık Weight kg	Kapasite Capacity lt	Fiyatı Price Euro
EMP.YT.01	Yağ Ayırıcı Grease Seperator	655x340x290	20	10	440
EMP.YT.02	Yağ Ayırıcı Grease Seperator	730x413x420	29	16	520
EMP.YT.03	Yağ Ayırıcı Grease Seperator	900x540x640	52	50	600



Çalışma Tezgahları Work Table

Çalışma Tezgahı (Demonte) / Work Table (Demontable)

Çalışma Tezgahı Alt Rafı (Demonte) / Work Table With Bottom Shelf (Demontable)

Çalışma Tezgahı Alt - Ara Rafı (Demonte) / Work Table With Bottom - Intermediate Shelf (Demontable)

Çalışma Tezgahı Polietilen (Demonte) / Work Table Polyethylen (Demontable)

Çalışma Tezgahı Alt Rafı Polietilen (Demonte) / Work Table With Bottom Shelf Polyethylen (Demontable)

Dolaplı Çalışma Tezgahı (Kaynaklı) / Work Table Cabinet (Welded)

Dolaplı Çalışma Tezgahı Ara Rafı (Kaynaklı) / Work Table Cabinet - Intermediate Shelf (Welded)

Blok Çekmece Ünitesi / Drawers Unit

Çalışma Tezgahı (Demonte)
Work Table (Demontable)



60'lık Seri / 60's Series

Kod Code	Ürün Adı Description	Ebatlar Dimension mm	Fiyatı Price Euro
EMP.AT.6080	Çalışma Tezgahı Work Table	800x600x850	190
EMP.AT.60100	Çalışma Tezgahı Work Table	1000x600x850	210
EMP.AT.60120	Çalışma Tezgahı Work Table	1200x600x850	235
EMP.AT.60140	Çalışma Tezgahı Work Table	1400x600x850	260
EMP.AT.60160	Çalışma Tezgahı Work Table	1600x600x850	285
EMP.AT.60180	Çalışma Tezgahı Work Table	1800x600x850	310
EMP.AT.60200	Çalışma Tezgahı Work Table	2000x600x850	330
EMP.AT.60220	Çalışma Tezgahı Work Table	2200x600x850	375
EMP.AT.60240	Çalışma Tezgahı Work Table	2400x600x850	400

70'lık Seri / 70's Series

Kod Code	Ürün Adı Description	Ebatlar Dimension mm	Fiyatı Price Euro
EMP.AT.7080	Çalışma Tezgahı Work Table	800x700x850	200
EMP.AT.70100	Çalışma Tezgahı Work Table	1000x700x850	225
EMP.AT.70120	Çalışma Tezgahı Work Table	1200x700x850	250
EMP.AT.70140	Çalışma Tezgahı Work Table	1400x700x850	275
EMP.AT.70160	Çalışma Tezgahı Work Table	1600x700x850	300
EMP.AT.70180	Çalışma Tezgahı Work Table	1800x700x850	325
EMP.AT.70200	Çalışma Tezgahı Work Table	2000x700x850	350
EMP.AT.70220	Çalışma Tezgahı Work Table	2200x700x850	400
EMP.AT.70240	Çalışma Tezgahı Work Table	2400x700x850	425

Köşe Tezgahları / Corner Table

Kod Code	Ürün Adı Description	Ebatlar Dimension mm	Fiyatı Price Euro
EMP.KST.6060-L	Köşe Tezgahı Sol Corner Table Left	600x600x850	120
EMP.KST.6060-R	Köşe Tezgahı Sağ Corner Table Right	600x600x850	120
EMP.KST.7070-L	Köşe Tezgahı Sol Corner Table Left	700x700x850	135
EMP.KST.7070-R	Köşe Tezgahı Sağ Corner Table Right	700x700x850	135



• Ürün siparişlerinizde sırt yönünü belirtiniz. / Please, specify direction of back with the order.

- Tüm ürünler demonte olup, paslanmaz çelikten üretilmektedir.
- Tezgahlar standart olarak sırtlı üretilmektedir.
- Arkası sırsız tezgahları lütfen bildiriniz.
- Tezgahlar ayarlanabilir ayaklıdır.

- All products are demontable and stainless steel.
- Tables are produced with back standarty.
- Please specify if you don't want back with the table.
- All tables are adjustable feet.

Çalışma Tezgahı Alt Rafı (Demonte) Work Table With Bottom Shelf (Demontable)



60'lık Seri / 60's Series

70'lık Seri / 70's Series

Kod Code	Ürün Adı Description	Ebatlar Dimension mm	Fiyatı Price Euro
EMP.ATT.6080	Çalışma Tezgahı Alt Rafı Work Table With Bottom Shelf	800x600x850	210
EMP.ATT.60100	Çalışma Tezgahı Alt Rafı Work Table With Bottom Shelf	1000x600x850	240
EMP.ATT.60120	Çalışma Tezgahı Alt Rafı Work Table With Bottom Shelf	1200x600x850	260
EMP.ATT.60140	Çalışma Tezgahı Alt Rafı Work Table With Bottom Shelf	1400x600x850	295
EMP.ATT.60160	Çalışma Tezgahı Alt Rafı Work Table With Bottom Shelf	1600x600x850	330
EMP.ATT.60180	Çalışma Tezgahı Alt Rafı Work Table With Bottom Shelf	1800x600x850	360
EMP.ATT.60200	Çalışma Tezgahı Alt Rafı Work Table With Bottom Shelf	2000x600x850	390
EMP.ATT.60220	Çalışma Tezgahı Alt Rafı Work Table With Bottom Shelf	2200x600x850	445
EMP.ATT.60240	Çalışma Tezgahı Alt Rafı Work Table With Bottom Shelf	2400x600x850	470

Kod Code	Ürün Adı Description	Ebatlar Dimension mm	Fiyatı Price Euro
EMP.ATT.7080	Çalışma Tezgahı Alt Rafı Work Table With Bottom Shelf	800x700x850	220
EMP.ATT.70100	Çalışma Tezgahı Alt Rafı Work Table With Bottom Shelf	1000x700x850	250
EMP.ATT.70120	Çalışma Tezgahı Alt Rafı Work Table With Bottom Shelf	1200x700x850	290
EMP.ATT.70140	Çalışma Tezgahı Alt Rafı Work Table With Bottom Shelf	1400x700x850	320
EMP.ATT.70160	Çalışma Tezgahı Alt Rafı Work Table With Bottom Shelf	1600x700x850	355
EMP.ATT.70180	Çalışma Tezgahı Alt Rafı Work Table With Bottom Shelf	1800x700x850	390
EMP.ATT.70200	Çalışma Tezgahı Alt Rafı Work Table With Bottom Shelf	2000x700x850	440
EMP.ATT.70220	Çalışma Tezgahı Alt Rafı Work Table With Bottom Shelf	2200x700x850	475
EMP.ATT.70240	Çalışma Tezgahı Alt Rafı Work Table With Bottom Shelf	2400x700x850	510

Köşe Tezgahı Alt Rafı / Corner Table With Bottom Shelf



Kod Code	Ürün Adı Description	Ebatlar Dimension mm	Fiyatı Price Euro
EMP.KKT.6060-L	Köşe Tezgahı Alt Rafı Sol Corner Table With Bottom Shelf Left	600x600x850	140
EMP.KKT.6060-R	Köşe Tezgahı Alt Rafı Sağ Corner Table With Bottom Shelf Right	600x600x850	140
EMP.KKT.7070-L	Köşe Tezgahı Alt Rafı Sol Corner Table With Bottom Shelf Left	700x700x850	165
EMP.KKT.7070-R	Köşe Tezgahı Alt Rafı Sağ Corner Table With Bottom Shelf Right	700x700x850	165

• Ürün siparişlerinizde sırt yönünü belirtiniz. / Please, specify direction of back with the order.

- Tüm ürünler demonte olup, paslanmaz çelikten üretilmektedir.
- Tezgahlar standart olarak sırtlı üretilmektedir.
- Arkası sırsız tezgahları lütfen bildiriniz.
- Tezgahlar ayarlanabilir ayaklıdır.

- All products are demontable and stainless steel.
- Tables are produced with back standarty.
- Please specify if you don't want back with the table.
- All tables are adjustable feet.

Çalışma Tezgahı Alt - Ara Rafı (Demonte)
Work Table With Bottom - Intermediate Shelf (Demontable)



60'lık Seri / 60's Series

Kod Code	Ürün Adı Description	Ebatlar Dimension mm	Fiyatı Price Euro
EMP.ATT2.6080	Çalışma Tezgahı Alt Rafı-Ara Rafı Work Table With Bottom-Intermediate Shelf	800x600x850	250
EMP.ATT2.60100	Çalışma Tezgahı Alt Rafı-Ara Rafı Work Table With Bottom-Intermediate Shelf	1000x600x850	285
EMP.ATT2.60120	Çalışma Tezgahı Alt Rafı-Ara Rafı Work Table With Bottom-Intermediate Shelf	1200x600x850	320
EMP.ATT2.60140	Çalışma Tezgahı Alt Rafı-Ara Rafı Work Table With Bottom-Intermediate Shelf	1400x600x850	360
EMP.ATT2.60160	Çalışma Tezgahı Alt Rafı-Ara Rafı Work Table With Bottom-Intermediate Shelf	1600x600x850	400
EMP.ATT2.60180	Çalışma Tezgahı Alt Rafı-Ara Rafı Work Table With Bottom-Intermediate Shelf	1800x600x850	440
EMP.ATT2.60200	Çalışma Tezgahı Alt Rafı-Ara Rafı Work Table With Bottom-Intermediate Shelf	2000x600x850	480
EMP.ATT2.60220	Çalışma Tezgahı Alt Rafı-Ara Rafı Work Table With Bottom-Intermediate Shelf	2200x600x850	525
EMP.ATT2.60240	Çalışma Tezgahı Alt Rafı-Ara Rafı Work Table With Bottom-Intermediate Shelf	2400x600x850	560

70'lık Seri / 70's Series

Kod Code	Ürün Adı Description	Ebatlar Dimension mm	Fiyatı Price Euro
EMP.ATT2.7080	Çalışma Tezgahı Alt Rafı-Ara Rafı Work Table With Bottom-Intermediate Shelf	800x700x850	270
EMP.ATT2.70100	Çalışma Tezgahı Alt Rafı-Ara Rafı Work Table With Bottom-Intermediate Shelf	1000x700x850	310
EMP.ATT2.70120	Çalışma Tezgahı Alt Rafı-Ara Rafı Work Table With Bottom-Intermediate Shelf	1200x700x850	350
EMP.ATT2.70140	Çalışma Tezgahı Alt Rafı-Ara Rafı Work Table With Bottom-Intermediate Shelf	1400x700x850	395
EMP.ATT2.70160	Çalışma Tezgahı Alt Rafı-Ara Rafı Work Table With Bottom-Intermediate Shelf	1600x700x850	435
EMP.ATT2.70180	Çalışma Tezgahı Alt Rafı-Ara Rafı Work Table With Bottom-Intermediate Shelf	1800x700x850	480
EMP.ATT2.70200	Çalışma Tezgahı Alt Rafı-Ara Rafı Work Table With Bottom-Intermediate Shelf	2000x700x850	520
EMP.ATT2.70220	Çalışma Tezgahı Alt Rafı-Ara Rafı Work Table With Bottom-Intermediate Shelf	2200x700x850	570
EMP.ATT2.70240	Çalışma Tezgahı Alt Rafı-Ara Rafı Work Table With Bottom-Intermediate Shelf	2400x700x850	610

Köşe Tezgahı Alt - Ara Rafı / Corner Table With Bottom - Intermediate Shelf

Kod Code	Ürün Adı Description	Ebatlar Dimension mm	Fiyatı Price Euro
EMP.KTTA.6060-L	Köşe Tezgahı Alt-Ara Rafı Sol Corner Table With Bottom-Intermediate Shelf Left	600x600x850	185
EMP.KTTA.6060-R	Köşe Tezgahı Alt-Ara Rafı Sağ Corner Table With Bottom-Intermediate Shelf Right	600x600x850	185
EMP.KTTA.7070-L	Köşe Tezgahı Alt-Ara Rafı Sol Corner Table With Bottom-Intermediate Shelf Left	700x700x850	220
EMP.KTTA.7070-R	Köşe Tezgahı Alt-Ara Rafı Sağ Corner Table With Bottom-Intermediate Shelf Right	700x700x850	220

• Ürün siparişlerinizde sırt yönünü belirtiniz. / Please, specify direction of back with the order.

- Tüm ürünler demonte olup, paslanmaz çelikten üretilmektedir.
- Tezgahlar standart olarak sırtlı üretilmektedir.
- Arkası sırsız tezgahları lütfen bildiriniz.
- Tezgahlar ayarlanabilir ayaklıdır.

- All products are demontable and stainless steel.
- Tables are produced with back standarty.
- Please specify if you don't want back with the table.
- All tables are adjustable feet.

Çalışma Tezgahı Polietilen (Demonte) Work Table Polyethylen (Demontable)



60'lık Seri / 60's Series

Kod Code	Ürün Adı Description	Ebatlar Dimension mm	Fiyatı Price Euro
EMP.PT.6080	Çalışma Tezgahı Polietilen Work Table Polyethylen	800x600x850	305
EMP.PT.60100	Çalışma Tezgahı Polietilen Work Table Polyethylen	1000x600x850	355
EMP.PT.60120	Çalışma Tezgahı Polietilen Work Table Polyethylen	1200x600x850	410
EMP.PT.60140	Çalışma Tezgahı Polietilen Work Table Polyethylen	1400x600x850	465
EMP.PT.60160	Çalışma Tezgahı Polietilen Work Table Polyethylen	1600x600x850	520
EMP.PT.60180	Çalışma Tezgahı Polietilen Work Table Polyethylen	1800x600x850	575
EMP.PT.60200	Çalışma Tezgahı Polietilen Work Table Polyethylen	2000x600x850	630
EMP.PT.60220	Çalışma Tezgahı Polietilen Work Table Polyethylen	2200x600x850	685
EMP.PT.60240	Çalışma Tezgahı Polietilen Work Table Polyethylen	2400x600x850	740

70'lık Seri / 70's Series

Kod Code	Ürün Adı Description	Ebatlar Dimension mm	Fiyatı Price Euro
EMP.PT.7080	Çalışma Tezgahı Polietilen Work Table Polyethylen	800x700x850	330
EMP.PT.70100	Çalışma Tezgahı Polietilen Work Table Polyethylen	1000x700x850	390
EMP.PT.70120	Çalışma Tezgahı Polietilen Work Table Polyethylen	1200x700x850	455
EMP.PT.70140	Çalışma Tezgahı Polietilen Work Table Polyethylen	1400x700x850	515
EMP.PT.70160	Çalışma Tezgahı Polietilen Work Table Polyethylen	1600x700x850	575
EMP.PT.70180	Çalışma Tezgahı Polietilen Work Table Polyethylen	1800x700x850	635
EMP.PT.70200	Çalışma Tezgahı Polietilen Work Table Polyethylen	2000x700x850	700
EMP.PT.70220	Çalışma Tezgahı Polietilen Work Table Polyethylen	2200x700x850	760
EMP.PT.70240	Çalışma Tezgahı Polietilen Work Table Polyethylen	2400x700x850	820



Polietilen Et Kütüğü / Polyethylen Meat Block

Kod Code	Ürün Adı Description	Ebatlar Dimension mm	Fiyatı Price Euro
EMP.PTE.5050	Polietilen Et Kütüğü Polyethylen Meat Block	500x500x850	270
EMP.PTE.6060	Polietilen Et Kütüğü Polyethylen Meat Block	600x600x850	350

• 10 cm polietilen kalınlığı / 10 cm polyethylen thickness

- Tüm ürünler demonte olup, paslanmaz çelikten üretilmektedir.
- Tezgahlar standart olarak sırtlı üretilmektedir.
- Arkası sırtsız tezgahları lütfen bildirin.
- Tezgahlar ayarlanabilir ayaklıdır.

- All products are demontable and stainless steel.
- Tables are produced with back standarty.
- Please specify if you don't want back with the table.
- All tables are adjustable feet.

Çalışma Tezgahı Alt Rafı Polietilen (Demonte)
Work Table With Bottom Shelf Polyethylen (Demontable)



60'lık Seri / 60's Series

Kod Code	Ürün Adı Description	Ebatlar Dimension mm	Fiyatı Price Euro
EMP.PTT.6080	Çalışma Tezgahı Alt Rafı Polietilen Work Table With Bottom-Intermediate Shelf	800x600x850	320
EMP.PTT.60100	Çalışma Tezgahı Alt Rafı Polietilen Work Table With Bottom-Intermediate Shelf	1000x600x850	380
EMP.PTT.60120	Çalışma Tezgahı Alt Rafı Polietilen Work Table With Bottom-Intermediate Shelf	1200x600x850	440
EMP.PTT.60140	Çalışma Tezgahı Alt Rafı Polietilen Work Table With Bottom-Intermediate Shelf	1400x600x850	500
EMP.PTT.60160	Çalışma Tezgahı Alt Rafı Polietilen Work Table With Bottom-Intermediate Shelf	1600x600x850	560
EMP.PTT.60180	Çalışma Tezgahı Alt Rafı Polietilen Work Table With Bottom-Intermediate Shelf	1800x600x850	620
EMP.PTT.60200	Çalışma Tezgahı Alt Rafı Polietilen Work Table With Bottom-Intermediate Shelf	2000x600x850	680
EMP.PTT.60220	Çalışma Tezgahı Alt Rafı Polietilen Work Table With Bottom-Intermediate Shelf	2200x600x850	745
EMP.PTT.60240	Çalışma Tezgahı Alt Rafı Polietilen Work Table With Bottom-Intermediate Shelf	2400x600x850	800

70'lık Seri / 70's Series

Kod Code	Ürün Adı Description	Ebatlar Dimension mm	Fiyatı Price Euro
EMP.PTT.7080	Çalışma Tezgahı Alt Rafı Polietilen Work Table With Bottom-Intermediate Shelf	800x700x850	355
EMP.PTT.70100	Çalışma Tezgahı Alt Rafı Polietilen Work Table With Bottom-Intermediate Shelf	1000x700x850	425
EMP.PTT.70120	Çalışma Tezgahı Alt Rafı Polietilen Work Table With Bottom-Intermediate Shelf	1200x700x850	490
EMP.PTT.70140	Çalışma Tezgahı Alt Rafı Polietilen Work Table With Bottom-Intermediate Shelf	1400x700x850	560
EMP.PTT.70160	Çalışma Tezgahı Alt Rafı Polietilen Work Table With Bottom-Intermediate Shelf	1600x700x850	625
EMP.PTT.70180	Çalışma Tezgahı Alt Rafı Polietilen Work Table With Bottom-Intermediate Shelf	1800x700x850	695
EMP.PTT.70200	Çalışma Tezgahı Alt Rafı Polietilen Work Table With Bottom-Intermediate Shelf	2000x700x850	760
EMP.PTT.70220	Çalışma Tezgahı Alt Rafı Polietilen Work Table With Bottom-Intermediate Shelf	2200x700x850	835
EMP.PTT.70240	Çalışma Tezgahı Alt Rafı Polietilen Work Table With Bottom-Intermediate Shelf	2400x700x850	900

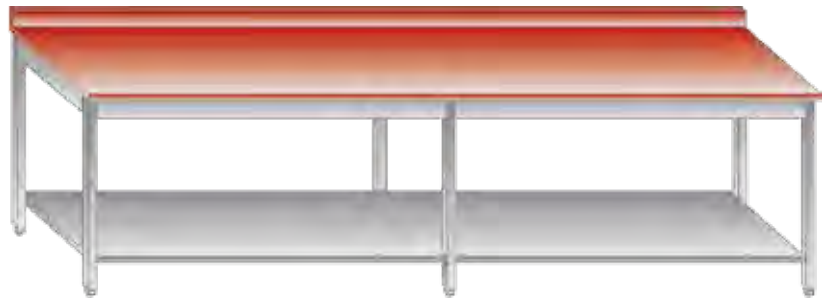

- Tüm ürünler demonte olup, paslanmaz çelikten üretilmektedir.
- Tezgahlar standart olarak sırtlı üretilmektedir.
- Arkası sırsız tezgahları lütfen bildiriniz.
- Tezgahlar ayarlanabilir ayaklıdır.

- All products are demontable and stainless steel.
- Tables are produced with back standarty.
- Please specify if you don't want back with the table.
- All tables are adjustable feet.

Dolaplı Çalışma Tezgahı (Kaynaklı)
Work Table Cabinet (Welded)

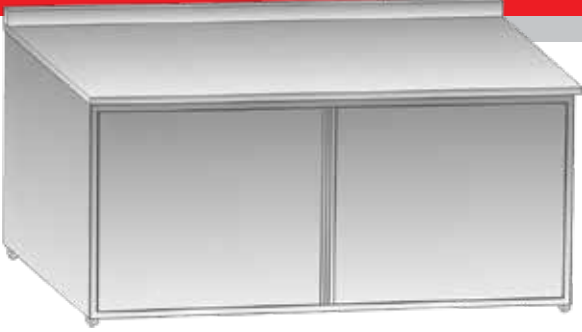

60'lık Seri / 60's Series

Kod Code	Ürün Adı Description	Ebatlar Dimension mm	Fiyatı Price Euro
EMP.DLP.60120	Dolaplı Çalışma Tezgahı Work Table Cabinet	1200x600x850	540
EMP.DLP.60140	Dolaplı Çalışma Tezgahı Work Table Cabinet	1400x600x850	610
EMP.DLP.60160	Dolaplı Çalışma Tezgahı Work Table Cabinet	1600x600x850	685
EMP.DLP.60180	Dolaplı Çalışma Tezgahı Work Table Cabinet	1800x600x850	750
EMP.DLP.60200	Dolaplı Çalışma Tezgahı Work Table Cabinet	2000x600x850	825

70'lık Seri / 70's Series

Kod Code	Ürün Adı Description	Ebatlar Dimension mm	Fiyatı Price Euro
EMP.DLP.70120	Dolaplı Çalışma Tezgahı Work Table Cabinet	1200x700x850	590
EMP.DLP.70140	Dolaplı Çalışma Tezgahı Work Table Cabinet	1400x700x850	665
EMP.DLP.70160	Dolaplı Çalışma Tezgahı Work Table Cabinet	1600x700x850	740
EMP.DLP.70180	Dolaplı Çalışma Tezgahı Work Table Cabinet	1800x700x850	815
EMP.DLP.70200	Dolaplı Çalışma Tezgahı Work Table Cabinet	2000x700x850	890

- Paslanmaz çelikten üretilmektedir.
- Tezgahlar standart olarak sırtlı üretilmektedir.
- Arkası sırtsız tezgahları lütfen bildiriniz.
- Tezgahlar ayarlanabilir ayaklıdır.

- Stainless steel.
- Tables are produced with back standarty.
- Please specify if you don't want back with the table.
- All tables are adjustable feet.

Dolaplı Çalışma Tezgahı Ara Rafı (Kaynaklı)
Work Table Cabinet - Intermediate Shelf (Welded)

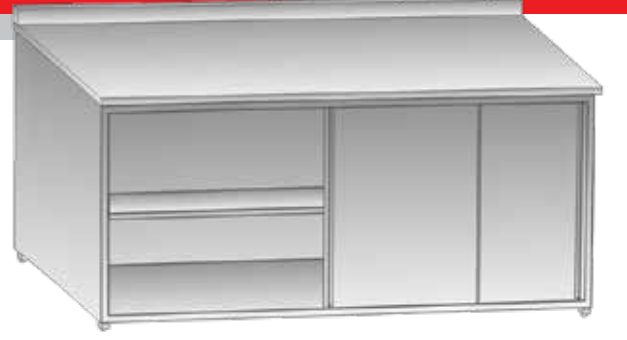

60'lık Seri / 60's Series

Kod Code	Ürün Adı Description	Ebatlar Dimension mm	Fiyatı Price Euro
EMP.DLPA.60120	Dolaplı Çalışma Tezgahı Ara Rafı Work Table Cabinet - Intermediate Shelf	1200x600x850	595
EMP.DLPA.60140	Dolaplı Çalışma Tezgahı Ara Rafı Work Table Cabinet - Intermediate Shelf	1400x600x850	670
EMP.DLPA.60160	Dolaplı Çalışma Tezgahı Ara Rafı Work Table Cabinet - Intermediate Shelf	1600x600x850	750
EMP.DLPA.60180	Dolaplı Çalışma Tezgahı Ara Rafı Work Table Cabinet - Intermediate Shelf	1800x600x850	825
EMP.DLPA.60200	Dolaplı Çalışma Tezgahı Ara Rafı Work Table Cabinet - Intermediate Shelf	2000x600x850	900

70'lık Seri / 70's Series

Kod Code	Ürün Adı Description	Ebatlar Dimension mm	Fiyatı Price Euro
EMP.DLPA.70120	Dolaplı Çalışma Tezgahı Ara Rafı Work Table Cabinet - Intermediate Shelf	1200x700x850	650
EMP.DLPA.70140	Dolaplı Çalışma Tezgahı Ara Rafı Work Table Cabinet - Intermediate Shelf	1400x700x850	735
EMP.DLPA.70160	Dolaplı Çalışma Tezgahı Ara Rafı Work Table Cabinet - Intermediate Shelf	1600x700x850	815
EMP.DLPA.70180	Dolaplı Çalışma Tezgahı Ara Rafı Work Table Cabinet - Intermediate Shelf	1800x700x850	895
EMP.DLPA.70200	Dolaplı Çalışma Tezgahı Ara Rafı Work Table Cabinet - Intermediate Shelf	2000x700x850	980

- Paslanmaz çelikten üretilmektedir.
- Tezgahlar standart olarak sırtlı üretilmektedir.
- Arkası sırtsız tezgahları lütfen bildiriniz.
- Tezgahlar ayarlanabilir ayaklıdır.

- Stainless steel.
- Tables are produced with back standarty.
- Please specify if you don't want back with the table.
- All tables are adjustable feet.

Blok Çekmece Ünitesi
Drawers Unit

Kod Code	Ürün Adı Description	Ebatlar Dimension mm	Fiyatı Price Euro
EMP.BLK.506085	Blok Çekmece Ünitesi Drawers Unit	500x600x850	805
EMP.BLK.507085	Blok Çekmece Ünitesi Drawers Unit	500x700x850	830

- Çekmeceler paslanmaz çelikten üretilmektedir.
- Çekmece ünitesi standart olarak sırtlı üretilmektedir.
- Arkası sırtsız tezgahları lütfen bildiriniz.
- Tezgahlar ayarlanabilir ayaklıdır.

- Stainless steel.
- Drawers are produced with back standarty.
- Please specify if you don't want back with the table.
- All tables are adjustable feet.



Evyeli Tezgahlar **Sink With**

- 1 Evyeli Tezgahlar 600 / 700 (Demonte) / Work Table With 1 Sink 600 / 700 (Demontable)**
- 1 Evyeli Tezgahlar 600 (Demonte) / Work Table With 1 Sink 600 (Demontable)**
- 1 Evyeli Tezgahlar 700 (Demonte) / Work Table With 1 Sink 700 (Demontable)**
- 1 Evyeli Tezgahlar 600 (Demonte) / Work Table With 1 Sink 600 (Demontable)**
- 1 Evyeli Tezgahlar 700 (Demonte) / Work Table With 1 Sink 700 (Demontable)**
- 2 Evyeli Tezgahlar 600 (Demonte) / Work Table With 2 Sink 600 (Demontable)**
- 2 Evyeli Tezgahlar 700 (Demonte) / Work Table With 2 Sink 700 (Demontable)**
- 2 Evyeli Tezgahlar 600 (Demonte) / Work Table With 2 Sink 600 (Demontable)**
- 2 Evyeli Tezgahlar 700 (Demonte) / Work Table With 2 Sink 700 (Demontable)**
- 3 Evyeli Tezgahlar 600 - 700 (Demonte) / Work Table With 3 Sink 600 - 700 (Demontable)**
- Duvar Dolabı (Sürgü Kapaklı) / Wall Cabinet (Sliding Doors)**
- Duvar Rafı Ayarlanabilir (Demonte) / Wall Shelf Adjustable (Demontable)**
- Duvar Rafı Perfore Ayarlanabilir (Demonte) / Wall Shelf Perforated Adjustable (Demontable)**

1 Evyeli Tezgahlar 600 / 700 (Demonte)
Work Table With 1 Sink 600 / 700 (Demontable)



Kod Code	Ürün Adı Description	Ebatlar Dimension mm	Evyeye Sink mm	Fiyatı Price Euro
EMP.E.66085-1E	Tek Evyeli Tezgah Sink With 1 Bowl	600x600x850	500x400x250	295
EMP.E.76085-1E	Tek Evyeli Tezgah Sink With 1 Bowl	700x600x850	500x400x250	330
EMP.E.67085-1E	Tek Evyeli Tezgah Sink With 1 Bowl	600x700x850	400x500x300	325
EMP.E.77085-1E	Tek Evyeli Tezgah Sink With 1 Bowl	700x700x850	500x500x300	385



Kod Code	Ürün Adı Description	Ebatlar Dimension mm	Evyeye Sink mm	Fiyatı Price Euro
EMP.E.66085-1ET	Tek Evyeli Tezgah Sink With 1 Bowl	600x600x850	500x400x250	325
EMP.E.76085-1ET	Tek Evyeli Tezgah Sink With 1 Bowl	700x600x850	500x400x250	360
EMP.E.67085-1ET	Tek Evyeli Tezgah Sink With 1 Bowl	600x700x850	400x500x300	360
EMP.E.77085-1ET	Tek Evyeli Tezgah Sink With 1 Bowl	700x700x850	500x500x300	425

- Tüm ürünler demonte olup, paslanmaz çelikten üretilmektedir.
- Tezgahlar standart olarak sırtlı üretilmektedir.
- Arkası sırtsız tezgahları lütfen bildiriniz.
- Tezgahlar ayarlanabilir ayaklıdır.

- All products are demontable and stainless steel.
- Tables are produced with back standarty.
- Please specify if you don't want back with the table.
- All tables are adjustable feet.

1 Evyeli Tezgahlar 600 (Demonte)
Work Table With 1 Sink 600 (Demontable)



Kod Code	Ürün Adı Description	Ebatlar Dimension mm	Evyeye Sink mm	Fiyatı Price Euro
EMPE.61085-1E-R	Tek Evyeli Tezgah Sağ Sink With 1 Bowl Right	1000x600x850	500x400x250	375
EMPE.61085-1E-L	Tek Evyeli Tezgah Sol Sink With 1 Bowl Left	1000x600x850	500x400x250	375
EMPE.61285-1E-R	Tek Evyeli Tezgah Sağ Sink With 1 Bowl Right	1200x600x850	500x400x250	410
EMPE.61285-1E-L	Tek Evyeli Tezgah Sol Sink With 1 Bowl Left	1200x600x850	500x400x250	410
EMPE.61485-1E-R	Tek Evyeli Tezgah Sağ Sink With 1 Bowl Right	1400x600x850	500x400x250	450
EMPE.61485-1E-L	Tek Evyeli Tezgah Sol Sink With 1 Bowl Left	1400x600x850	500x400x250	450
EMPE.61685-1E-R	Tek Evyeli Tezgah Sağ Sink With 1 Bowl Right	1600x600x850	500x400x250	495
EMPE.61685-1E-L	Tek Evyeli Tezgah Sol Sink With 1 Bowl Left	1600x600x850	500x400x250	495

- Tüm ürünler demonte olup, paslanmaz çelikten üretilmektedir.
- Tezgahlar standart olarak sırtlı üretilmektedir.
- Arkası sırtsız tezgahları lütfen bildiriniz.
- Tezgahlar ayarlanabilir ayaklıdır.

- All products are demontable and stainless steel.
- Tables are produced with back standarty.
- Please specify if you don't want back with the table.
- All tables are adjustable feet.

1 Evyeli Tezgahlar 700 (Demonte) Work Table With 1 Sink 700 (Demontable)



Kod Code	Ürün Adı Description	Ebatlar Dimension mm	Evyeye Sink mm	Fiyatı Price Euro
EMP.E.71085-1E-R	Tek Evyeli Tezgah Sağ Sink With 1 Bowl Right	1000x700x850	500x500x300	440
EMP.E.71085-1E-L	Tek Evyeli Tezgah Sol Sink With 1 Bowl Left	1000x700x850	500x500x300	440
EMP.E.71285-1E-R	Tek Evyeli Tezgah Sağ Sink With 1 Bowl Right	1200x700x850	500x500x300	475
EMP.E.71285-1E-L	Tek Evyeli Tezgah Sol Sink With 1 Bowl Left	1200x700x850	500x500x300	475
EMP.E.71485-1E-R	Tek Evyeli Tezgah Sağ Sink With 1 Bowl Right	1400x700x850	500x500x300	510
EMP.E.71485-1E-L	Tek Evyeli Tezgah Sol Sink With 1 Bowl Left	1400x700x850	500x500x300	510
EMP.E.71685-1E-R	Tek Evyeli Tezgah Sağ Sink With 1 Bowl Right	1600x700x850	500x500x300	565
EMP.E.71685-1E-L	Tek Evyeli Tezgah Sol Sink With 1 Bowl Left	1600x700x850	500x500x300	565

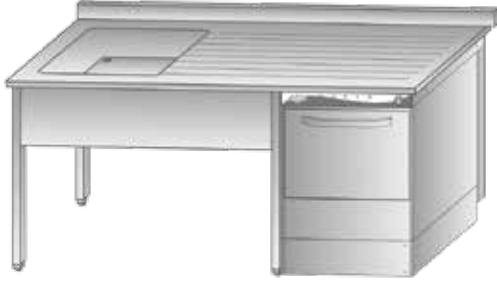

Kod Code	Ürün Adı Description	Ebatlar Dimension mm	Evyeye Sink mm	Fiyatı Price Euro
EMP.E.71485-1EM-R	Tek Evyeli Tezgah Sağ Sink With 1 Bowl Right	1400x700x850	500x500x300	475
EMP.E.71485-1EM-L	Tek Evyeli Tezgah Sol Sink With 1 Bowl Left	1400x700x850	500x500x300	475
EMP.E.71685-1EM-R	Tek Evyeli Tezgah Sağ Sink With 1 Bowl Right	1600x700x850	500x500x300	530
EMP.E.71685-1EM-L	Tek Evyeli Tezgah Sol Sink With 1 Bowl Left	1600x700x850	500x500x300	530
EMP.E.71885-1EM-R	Tek Evyeli Tezgah Sağ Sink With 1 Bowl Right	1800x700x850	500x500x300	565
EMP.E.71885-1EM-L	Tek Evyeli Tezgah Sol Sink With 1 Bowl Left	1800x700x850	500x500x300	565
EMP.E.72085-1EM-R	Tek Evyeli Tezgah Sağ Sink With 1 Bowl Right	2000x700x850	500x500x300	615
EMP.E.72085-1EM-L	Tek Evyeli Tezgah Sol Sink With 1 Bowl Left	2000x700x850	500x500x300	615

- Tüm ürünler demonte olup, paslanmaz çelikten üretilmektedir.
- Tezgahlar standart olarak sırtlı üretilmektedir.
- Arkası sırsız tezgahları lütfen bildiriniz.
- Tezgahlar ayarlanabilir ayaklıdır.

- All products are demontable and stainless steel.
- Tables are produced with back standarty.
- Please specify if you don't want back with the table.
- All tables are adjustable feet.

1 Evyeli Tezgahlar 600 (Demonte)
Work Table With 1 Sink 600 (Demontable)

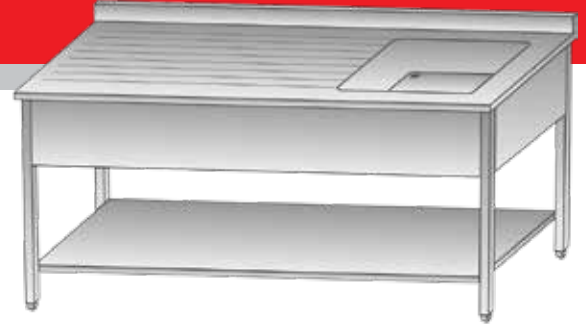

Kod Code	Ürün Adı Description	Ebatlar Dimension mm	Evyeye Sink mm	Fiyatı Price Euro
EMP.E.61085-1ET-R	Tek Evyeli Tezgah Sağ Sink With 1 Bowl Right	1000x600x850	500x400x250	410
EMP.E.61085-1ET-L	Tek Evyeli Tezgah Sol Sink With 1 Bowl Left	1000x600x850	500x400x250	410
EMP.E.61285-1ET-R	Tek Evyeli Tezgah Sağ Sink With 1 Bowl Right	1200x600x850	500x400x250	460
EMP.E.61285-1ET-L	Tek Evyeli Tezgah Sol Sink With 1 Bowl Left	1200x600x850	500x400x250	460
EMP.E.61485-1ET-R	Tek Evyeli Tezgah Sağ Sink With 1 Bowl Right	1400x600x850	500x400x250	510
EMP.E.61485-1ET-L	Tek Evyeli Tezgah Sol Sink With 1 Bowl Left	1400x600x850	500x400x250	510
EMP.E.61685-1ET-R	Tek Evyeli Tezgah Sağ Sink With 1 Bowl Right	1600x600x850	500x400x250	565
EMP.E.61685-1ET-L	Tek Evyeli Tezgah Sol Sink With 1 Bowl Left	1600x600x850	500x400x250	565

- Tüm ürünler demonte olup, paslanmaz çelikten üretilmektedir.
- Tezgahlar standart olarak sırtlı üretilmektedir.
- Arkası sırtsız tezgahları lütfen bildiriniz.
- Tezgahlar ayarlanabilir ayaklıdır.

- All products are demontable and stainless steel.
- Tables are produced with back standarty.
- Please specify if you don't want back with the table.
- All tables are adjustable feet.

1 Evyeli Tezgahlar 700 (Demonte) Work Table With 1 Sink 700 (Demontable)

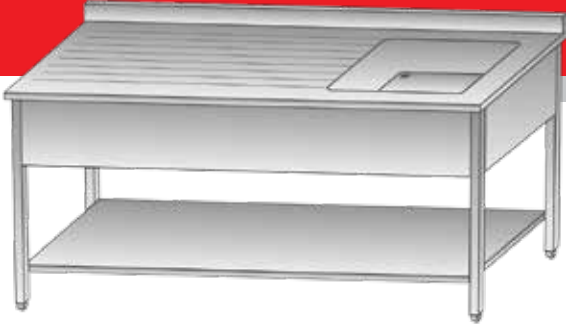

Kod Code	Ürün Adı Description	Ebatlar Dimension mm	Evye Sink mm	Fiyatı Price Euro
EMP.E.71085-1ET-R	Tek Evyeli Tezgah Sağ Sink With 1 Bowl Right	1000x700x850	500x500x300	495
EMP.E.71085-1ET-L	Tek Evyeli Tezgah Sol Sink With 1 Bowl Left	1000x700x850	500x500x300	495
EMP.E.71285-1ET-R	Tek Evyeli Tezgah Sağ Sink With 1 Bowl Right	1200x700x850	500x500x300	540
EMP.E.71285-1ET-L	Tek Evyeli Tezgah Sol Sink With 1 Bowl Left	1200x700x850	500x500x300	540
EMP.E.71485-1ET-R	Tek Evyeli Tezgah Sağ Sink With 1 Bowl Right	1400x700x850	500x500x300	580
EMP.E.71485-1ET-L	Tek Evyeli Tezgah Sol Sink With 1 Bowl Left	1400x700x850	500x500x300	580
EMP.E.71685-1ET-R	Tek Evyeli Tezgah Sağ Sink With 1 Bowl Right	1600x700x850	500x500x300	645
EMP.E.71685-1ET-L	Tek Evyeli Tezgah Sol Sink With 1 Bowl Left	1600x700x850	500x500x300	645

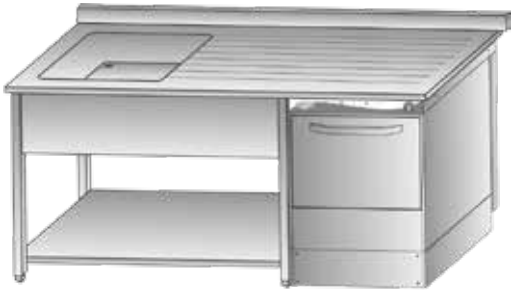

Kod Code	Ürün Adı Description	Ebatlar Dimension mm	Evye Sink mm	Fiyatı Price Euro
EMP.E.71485-1EMT-R	Tek Evyeli Tezgah Sağ Sink With 1 Bowl Right	1400x700x850	500x500x300	515
EMP.E.71485-1EMT-L	Tek Evyeli Tezgah Sol Sink With 1 Bowl Left	1400x700x850	500x500x300	515
EMP.E.71685-1EMT-R	Tek Evyeli Tezgah Sağ Sink With 1 Bowl Right	1600x700x850	500x500x300	565
EMP.E.71685-1EMT-L	Tek Evyeli Tezgah Sol Sink With 1 Bowl Left	1600x700x850	500x500x300	565
EMP.E.71885-1EMT-R	Tek Evyeli Tezgah Sağ Sink With 1 Bowl Right	1800x700x850	500x500x300	610
EMP.E.71885-1EMT-L	Tek Evyeli Tezgah Sol Sink With 1 Bowl Left	1800x700x850	500x500x300	610
EMP.E.72085-1EMT-R	Tek Evyeli Tezgah Sağ Sink With 1 Bowl Right	2000x700x850	500x500x300	665
EMP.E.72085-1EMT-L	Tek Evyeli Tezgah Sol Sink With 1 Bowl Left	2000x700x850	500x500x300	665

- Tüm ürünler demonte olup, paslanmaz çelikten üretilmektedir.
- Tezgahlar standart olarak sırtlı üretilmektedir.
- Arkası sırsız tezgahları lütfen bildiriniz.
- Tezgahlar ayarlanabilir ayaklıdır.

- All products are demontable and stainless steel.
- Tables are produced with back standarty.
- Please specify if you don't want back with the table.
- All tables are adjustable feet.

2 Evyeli Tezgahlar 600 (Demonte)
Work Table With 2 Sink 600 (Demontable)



Kod Code	Ürün Adı Description	Ebatlar Dimension mm	Evyel Sink mm	Fiyatı Price Euro
EMP.E.61485-2E-R	2 Evyeli Tezgah Sağ Sink With 2 Bowl Right	1400x600x850	500x400x250	540
EMP.E.61485-2E-L	2 Evyeli Tezgah Sol Sink With 2 Bowl Left	1400x600x850	500x400x250	540
EMP.E.61685-2E-R	2 Evyeli Tezgah Sağ Sink With 2 Bowl Right	1600x600x850	500x400x250	580
EMP.E.61685-2E-L	2 Evyeli Tezgah Sol Sink With 2 Bowl Left	1600x600x850	500x400x250	580
EMP.E.61885-2E-R	2 Evyeli Tezgah Sağ Sink With 2 Bowl Right	1800x600x850	500x400x250	620
EMP.E.61885-2E-L	2 Evyeli Tezgah Sol Sink With 2 Bowl Left	1800x600x850	500x400x250	620
EMP.E.62085-2E-R	2 Evyeli Tezgah Sağ Sink With 2 Bowl Right	2000x600x850	500x400x250	660
EMP.E.62085-2E-L	2 Evyeli Tezgah Sol Sink With 2 Bowl Left	2000x600x850	500x400x250	660

- Tüm ürünler demonte olup, paslanmaz çelikten üretilmektedir.
- Tezgahlar standart olarak sırtlı üretilmektedir.
- Arkası sırtsız tezgahları lütfen bildiriniz.
- Tezgahlar ayarlanabilir ayaklıdır.

- All products are demontable and stainless steel.
- Tables are produced with back standarty.
- Please specify if you don't want back with the table.
- All tables are adjustable feet.

2 Evyeli Tezgahlar 700 (Demonte)
Work Table With 2 Sink 700 (Demontable)



Kod Code	Ürün Adı Description	Ebatlar Dimension mm	Evye Sink mm	Fiyatı Price Euro
EMP.E.71485-2E-R	2 Evyeli Tezgah Sağ Sink With 2 Bowl Right	1400x700x850	400x500x250	595
EMP.E.71485-2E-L	2 Evyeli Tezgah Sol Sink With 2 Bowl Left	1400x700x850	400x500x250	595
EMP.E.71685-2E-R	2 Evyeli Tezgah Sağ Sink With 2 Bowl Right	1600x700x850	500x500x300	685
EMP.E.71685-2E-L	2 Evyeli Tezgah Sol Sink With 2 Bowl Left	1600x700x850	500x500x300	685
EMP.E.71885-2E-R	2 Evyeli Tezgah Sağ Sink With 2 Bowl Right	1800x700x850	500x500x300	720
EMP.E.71885-2E-L	2 Evyeli Tezgah Sol Sink With 2 Bowl Left	1800x700x850	500x500x300	720
EMP.E.72085-2E-R	2 Evyeli Tezgah Sağ Sink With 2 Bowl Right	2000x700x850	500x500x300	780
EMP.E.72085-2E-L	2 Evyeli Tezgah Sol Sink With 2 Bowl Left	2000x700x850	500x500x300	780

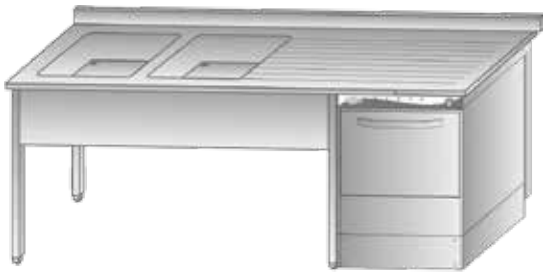

Kod Code	Ürün Adı Description	Ebatlar Dimension mm	Evye Sink mm	Fiyatı Price Euro
EMP.E.71685-2EM-R	2 Evyeli Tezgah Sağ Sink With 2 Bowl Right	1600x700x850	400x500x250	550
EMP.E.71685-2EM-L	2 Evyeli Tezgah Sol Sink With 2 Bowl Left	1600x700x850	400x500x250	550
EMP.E.71885-2EM-R	2 Evyeli Tezgah Sağ Sink With 2 Bowl Right	1800x700x850	500x500x300	575
EMP.E.71885-2EM-L	2 Evyeli Tezgah Sol Sink With 2 Bowl Left	1800x700x850	500x500x300	575
EMP.E.72085-2EM-R	2 Evyeli Tezgah Sağ Sink With 2 Bowl Right	2000x700x850	500x500x300	625
EMP.E.72085-2EM-L	2 Evyeli Tezgah Sol Sink With 2 Bowl Left	2000x700x850	500x500x300	625

- Tüm ürünler demonte olup, paslanmaz çelikten üretilmektedir.
- Tezgahlar standart olarak sırtlı üretilmektedir.
- Arkası sırtsız tezgahları lütfen bildiriniz.
- Tezgahlar ayarlanabilir ayaklıdır.

- All products are demontable and stainless steel.
- Tables are produced with back standarty.
- Please specify if you don't want back with the table.
- All tables are adjustable feet.

2 Evyeli Tezgahlar 600 (Demonte) Work Table With 2 Sink 600 (Demontable)



Kod Code	Ürün Adı Description	Ebatlar Dimension mm	Evyeye Sink mm	Fiyatı Price Euro
EMP.E.61485-2ET-R	2 Evyeli Tezgah Sağ Sink With 2 Bowl Right	1400x600x850	400x400x250	600
EMP.E.61485-2ET-L	2 Evyeli Tezgah Sol Sink With 2 Bowl Left	1400x600x850	400x400x250	600
EMP.E.61685-2ET-R	2 Evyeli Tezgah Sağ Sink With 2 Bowl Right	1600x600x850	400x400x250	650
EMP.E.61685-2ET-L	2 Evyeli Tezgah Sol Sink With 2 Bowl Left	1600x600x850	400x400x250	650
EMP.E.61885-2ET-R	2 Evyeli Tezgah Sağ Sink With 2 Bowl Right	1800x600x850	500x400x250	700
EMP.E.61885-2ET-L	2 Evyeli Tezgah Sol Sink With 2 Bowl Left	1800x600x850	500x400x250	700
EMP.E.62085-2ET-R	2 Evyeli Tezgah Sağ Sink With 2 Bowl Right	2000x600x850	500x400x250	750
EMP.E.62085-2ET-L	2 Evyeli Tezgah Sol Sink With 2 Bowl Left	2000x600x850	500x400x250	750

- Tüm ürünler demonte olup, paslanmaz çelikten üretilmektedir.
- Tezgahlar standart olarak sırtlı üretilmektedir.
- Arkası sırtsız tezgahları lütfen bildirin.
- Tezgahlar ayarlanabilir ayaklıdır.

- All products are demontable and stainless steel.
- Tables are produced with back standarty.
- Please specify if you don't want back with the table.
- All tables are adjustable feet.

2 Evyeli Tezgahlar 700 (Demonte) Work Table With 2 Sink 700 (Demontable)



Kod Code	Ürün Adı Description	Ebatlar Dimension mm	Evye Sink mm	Fiyatı Price Euro
EMP.E.71485-2ET-R	2 Evyeli Tezgah Sağ Sink With 2 Bowl Right	1400x700x850	400x500x250	660
EMP.E.71485-2ET-L	2 Evyeli Tezgah Sol Sink With 2 Bowl Left	1400x700x850	400x500x250	660
EMP.E.71685-2ET-R	2 Evyeli Tezgah Sağ Sink With 2 Bowl Right	1600x700x850	500x500x300	760
EMP.E.71685-2ET-L	2 Evyeli Tezgah Sol Sink With 2 Bowl Left	1600x700x850	500x500x300	760
EMP.E.71885-2ET-R	2 Evyeli Tezgah Sağ Sink With 2 Bowl Right	1800x700x850	500x500x300	810
EMP.E.71885-2ET-L	2 Evyeli Tezgah Sol Sink With 2 Bowl Left	1800x700x850	500x500x300	810
EMP.E.72085-2ET-R	2 Evyeli Tezgah Sağ Sink With 2 Bowl Right	2000x700x850	500x500x300	880
EMP.E.72085-2ET-L	2 Evyeli Tezgah Sol Sink With 2 Bowl Left	2000x700x850	500x500x300	880

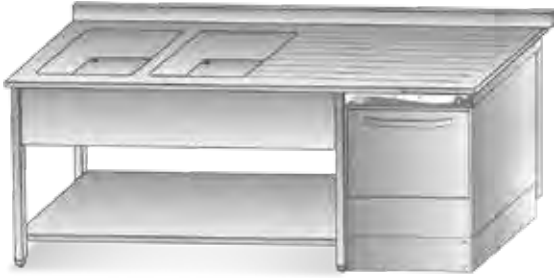

Kod Code	Ürün Adı Description	Ebatlar Dimension mm	Evye Sink mm	Fiyatı Price Euro
EMP.E.71685-2EMT-R	2 Evyeli Tezgah Sağ Sink With 2 Bowl Right	1600x700x850	400x500x250	590
EMP.E.71685-2EMT-L	2 Evyeli Tezgah Sol Sink With 2 Bowl Left	1600x700x850	400x500x250	590
EMP.E.71885-2EMT-R	2 Evyeli Tezgah Sağ Sink With 2 Bowl Right	1800x700x850	500x500x300	640
EMP.E.71885-2EMT-L	2 Evyeli Tezgah Sol Sink With 2 Bowl Left	1800x700x850	500x500x300	640
EMP.E.72085-2EMT-R	2 Evyeli Tezgah Sağ Sink With 2 Bowl Right	2000x700x850	500x500x300	695
EMP.E.72085-2EMT-L	2 Evyeli Tezgah Sol Sink With 2 Bowl Left	2000x700x850	500x500x300	695

- Tüm ürünler demonte olup, paslanmaz çelikten üretilmektedir.
- Tezgahlar standart olarak sırtlı üretilmektedir.
- Arkası sırtsız tezgahları lütfen bildiriniz.
- Tezgahlar ayarlanabilir ayaklıdır.

- All products are demontable and stainless steel.
- Tables are produced with back standarty.
- Please specify if you don't want back with the table.
- All tables are adjustable feet.

3 Evyeli Tezgahlar 600 - 700 (Demonte) Work Table With 3 Sink 600 - 700 (Demontable)



3 Evyeli Tezgah / Sink With 3 Bowl

Kod Code	Ürün Adı Description	Ebatlar Dimension mm	Evyeye Sink mm	Fiyatı Price Euro
EMP.E.61885-3E	3 Evyeli Tezgah Sink With 3 Bowl	1800x600x850	400x500x250	715
EMP.E.71885-3E	3 Evyeli Tezgah Sink With 3 Bowl	1800x700x850	500x500x300	840
EMP.E.72085-3E	3 Evyeli Tezgah Sink With 3 Bowl	2000x700x850	500x500x300	880

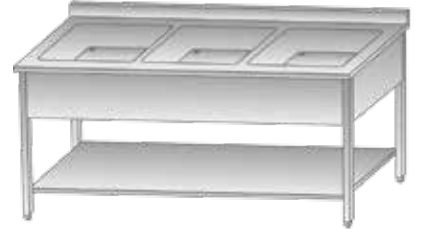

3 Evyeli Alt Rafli Tezgah / Sink With 3 Bowled Bottom Shelf

Kod Code	Ürün Adı Description	Ebatlar Dimension mm	Evyeye Sink mm	Fiyatı Price Euro
EMP.E.61885-3ET	3 Evyeli Tezgah Sink With 3 Bowl	1800x600x850	400x500x250	795
EMP.E.71885-3ET	3 Evyeli Tezgah Sink With 3 Bowl	1800x700x850	500x500x300	930
EMP.E.72085-3ET	3 Evyeli Tezgah Sink With 3 Bowl	2000x700x850	500x500x300	980



Sebze Yıkama Tezgahı / Vegetable Washing Unit

Kod Code	Ürün Adı Description	Ebatlar Dimension mm	Fiyatı Price Euro
EMP.SY.71285	Sebze Yıkama Tezgahı Vegetable Washing Unit	1200x700x850	650
EMP.SY.71485	Sebze Yıkama Tezgahı Vegetable Washing Unit	1400x700x850	735

Duvar Dolabı (Sürgü Kapaklı)
Wall Cabinet (Sliding Doors)

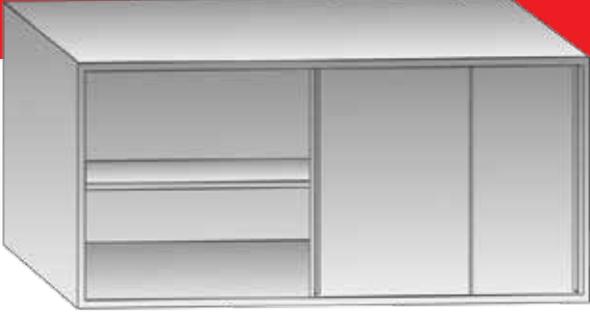

30'luk Seri / 30's Series

Kod Code	Ebatlar Dimension mm	Fiyatı Price Euro
EMP.DDS.3120	1200x300x600	365
EMP.DDS.3140	1400x300x600	410
EMP.DDS.3160	1600x300x600	455
EMP.DDS.3180	1800x300x600	495
EMP.DDS.3200	2000x300x600	540

40'luk Seri / 40's Series

Kod Code	Ebatlar Dimension mm	Fiyatı Price Euro
EMP.DDS.4120	1200x400x600	395
EMP.DDS.4140	1400x400x600	450
EMP.DDS.4160	1600x400x600	495
EMP.DDS.4180	1800x400x600	550
EMP.DDS.4200	2000x400x600	595

Duvar Rafı Ayarlanabilir (Demonte)
Wall Shelf Adjustable (Demontable)



30'luk Seri / 30's Series

Kod Code	Ebatlar Dimension mm	Fiyatı Price Euro
EMP.ET1.3080	800x300	60
EMP.ET1.30100	1000x300	70
EMP.ET1.30120	1200x300	80
EMP.ET1.30140	1400x300	90
EMP.ET1.30160	1600x300	95
EMP.ET1.30180	1800x300	105
EMP.ET1.30200	2000x300	110

40'luk Seri / 40's Series

Kod Code	Ebatlar Dimension mm	Fiyatı Price Euro
EMP.ET1.4080	800x400	70
EMP.ET1.40100	1000x400	85
EMP.ET1.40120	1200x400	95
EMP.ET1.40140	1400x400	105
EMP.ET1.40160	1600x400	115
EMP.ET1.40180	1800x400	130
EMP.ET1.40200	2000x400	145



30'luk Seri / 30's Series

Kod Code	Ebatlar Dimension mm	Fiyatı Price Euro
EMP.ET2.3080	800x300	120
EMP.ET2.30100	1000x300	140
EMP.ET2.30120	1200x300	155
EMP.ET2.30140	1400x300	170
EMP.ET2.30160	1600x300	190
EMP.ET2.30180	1800x300	205
EMP.ET2.30200	2000x300	220

40'luk Seri / 40's Series

Kod Code	Ebatlar Dimension mm	Fiyatı Price Euro
EMP.ET2.4080	800x400	145
EMP.ET2.40100	1000x400	165
EMP.ET2.40120	1200x400	180
EMP.ET2.40140	1400x400	205
EMP.ET2.40160	1600x400	220
EMP.ET2.40180	1800x400	240
EMP.ET2.40200	2000x400	265



30'luk Seri / 30's Series

Kod Code	Ebatlar Dimension mm	Fiyatı Price Euro
EMP.ET3.3080	800x300	180
EMP.ET3.30100	1000x300	210
EMP.ET3.30120	1200x300	230
EMP.ET3.30140	1400x300	260
EMP.ET3.30160	1600x300	280
EMP.ET3.30180	1800x300	310
EMP.ET3.30200	2000x300	340

40'luk Seri / 40's Series

Kod Code	Ebatlar Dimension mm	Fiyatı Price Euro
EMP.ET3.4080	800x400	220
EMP.ET3.40100	1000x400	240
EMP.ET3.40120	1200x400	275
EMP.ET3.40140	1400x400	300
EMP.ET3.40160	1600x400	340
EMP.ET3.40180	1800x400	365
EMP.ET3.40200	2000x400	395

Duvar Rafı Perfore Ayarlanabilir (Demonte)
Wall Shelf Perforated Adjustable (Demontable)



30'luk Seri / 30's Series

Kod Code	Ebatlar Dimension mm	Fiyatı Price Euro
EMP.ETP1.3080	800x300	70
EMP.ETP1.30100	1000x300	85
EMP.ETP1.30120	1200x300	95
EMP.ETP1.30140	1400x300	105
EMP.ETP1.30160	1600x300	110
EMP.ETP1.30180	1800x300	120
EMP.ETP1.30200	2000x300	125

40'luk Seri / 40's Series

Kod Code	Ebatlar Dimension mm	Fiyatı Price Euro
EMP.ETP1.4080	800x400	85
EMP.ETP1.40100	1000x400	95
EMP.ETP1.40120	1200x400	105
EMP.ETP1.40140	1400x400	120
EMP.ETP1.40160	1600x400	130
EMP.ETP1.40180	1800x400	150
EMP.ETP1.40200	2000x400	160

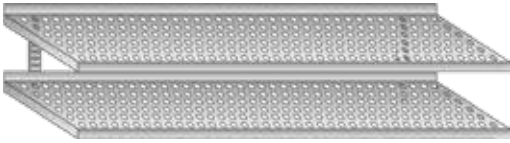

30'luk Seri / 30's Series

Kod Code	Ebatlar Dimension mm	Fiyatı Price Euro
EMP.ETP2.3080	800x300	145
EMP.ETP2.30100	1000x300	160
EMP.ETP2.30120	1200x300	175
EMP.ETP2.30140	1400x300	215
EMP.ETP2.30160	1600x300	230
EMP.ETP2.30180	1800x300	250
EMP.ETP2.30200	2000x300	265

40'luk Seri / 40's Series

Kod Code	Ebatlar Dimension mm	Fiyatı Price Euro
EMP.ETP2.4080	800x400	165
EMP.ETP2.40100	1000x400	190
EMP.ETP2.40120	1200x400	205
EMP.ETP2.40140	1400x400	250
EMP.ETP2.40160	1600x400	265
EMP.ETP2.40180	1800x400	285
EMP.ETP2.40200	2000x400	310

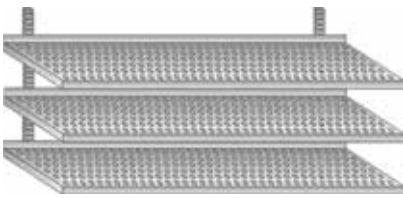

30'luk Seri / 30's Series

Kod Code	Ebatlar Dimension mm	Fiyatı Price Euro
EMP.ETP3.3080	800x300	215
EMP.ETP3.30100	1000x300	245
EMP.ETP3.30120	1200x300	265
EMP.ETP3.30140	1400x300	315
EMP.ETP3.30160	1600x300	335
EMP.ETP3.30180	1800x300	365
EMP.ETP3.30200	2000x300	395

40'luk Seri / 40's Series

Kod Code	Ebatlar Dimension mm	Fiyatı Price Euro
EMP.ETP3.4080	800x400	255
EMP.ETP3.40100	1000x400	275
EMP.ETP3.40120	1200x400	310
EMP.ETP3.40140	1400x400	360
EMP.ETP3.40160	1600x400	395
EMP.ETP3.40180	1800x400	420
EMP.ETP3.40200	2000x400	450



Davlumbazlar Hoods

Davlumbaz Duvar Tip Filtreli / Wall Type hood with Filters

Kutu Davlumbaz Duvar Tip Filtreli / Wall Type Box Hood With Filters

Davlumbaz Orta Tip Filtreli / Central Type Hood With Filters

Davlumbaz Orta Tip Filtreli / Central Type hood with Filters

Davlumbaz Orta Tip Filtreli / Central Type hood with Filters

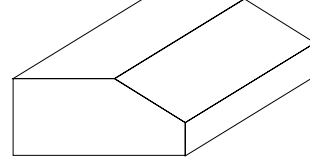
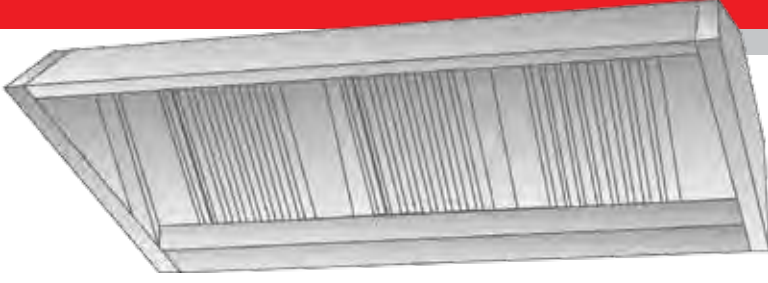
Davlumbaz Duvar Tip Filtreli
Wall Type hood with Filters

400 Seri / 400 Series

Kod Code	Ebatlar Dimension mm	Filtre Filters	Fiyatı Price Euro
EMP.DDVLK.1074	1000x700x400	1 Filtre / Filters	320
EMP.DDVLK.1574	1500x700x400	2 Filtre / Filters	435
EMP.DDVLK.2074	2000x700x400	3 Filtre / Filters	550
EMP.DDVLK.2574	2500x700x400	4 Filtre / Filters	665
EMP.DDVLK.3074	3000x700x400	5 Filtre / Filters	780
EMP.DDVLK.3574	3500x700x400	6 Filtre / Filters	980
EMP.DDVLK.4074	4000x700x400	6 Filtre / Filters	1.090
EMP.DDVLK.4574	4500x700x400	7 Filtre / Filters	1.210
EMP.DDVLK.5074	5000x700x400	8 Filtre / Filters	1.320

500 Seri / 500 Series

Kod Code	Ebatlar Dimension mm	Filtre Filters	Fiyatı Price Euro
EMP.DDVLK.1075	1000x700x500	1 Filtre / Filters	345
EMP.DDVLK.1575	1500x700x500	2 Filtre / Filters	470
EMP.DDVLK.2075	2000x700x500	3 Filtre / Filters	590
EMP.DDVLK.2575	2500x700x500	4 Filtre / Filters	710
EMP.DDVLK.3075	3000x700x500	5 Filtre / Filters	835
EMP.DDVLK.3575	3500x700x500	6 Filtre / Filters	1.050
EMP.DDVLK.4075	4000x700x500	6 Filtre / Filters	1.170
EMP.DDVLK.4575	4500x700x500	7 Filtre / Filters	1.295
EMP.DDVLK.5075	5000x700x500	8 Filtre / Filters	1.415

Kod Code	Ebatlar Dimension mm	Filtre Filters	Fiyatı Price Euro
EMP.DDVLK.1094	1000x900x400	1 Filtre / Filters	350
EMP.DDVLK.1594	1500x900x400	2 Filtre / Filters	470
EMP.DDVLK.2094	2000x900x400	3 Filtre / Filters	590
EMP.DDVLK.2594	2500x900x400	4 Filtre / Filters	715
EMP.DDVLK.3094	3000x900x400	5 Filtre / Filters	835
EMP.DDVLK.3594	3500x900x400	6 Filtre / Filters	1.055
EMP.DDVLK.4094	4000x900x400	6 Filtre / Filters	1.175
EMP.DDVLK.4594	4500x900x400	7 Filtre / Filters	1.295
EMP.DDVLK.5094	5000x900x400	8 Filtre / Filters	1.415

Kod Code	Ebatlar Dimension mm	Filtre Filters	Fiyatı Price Euro
EMP.DDVLK.1095	1000x900x500	1 Filtre / Filters	375
EMP.DDVLK.1595	1500x900x500	2 Filtre / Filters	505
EMP.DDVLK.2095	2000x900x500	3 Filtre / Filters	635
EMP.DDVLK.2595	2500x900x500	4 Filtre / Filters	765
EMP.DDVLK.3095	3000x900x500	5 Filtre / Filters	895
EMP.DDVLK.3595	3500x900x500	6 Filtre / Filters	1.130
EMP.DDVLK.4095	4000x900x500	6 Filtre / Filters	1.260
EMP.DDVLK.4595	4500x900x500	7 Filtre / Filters	1.400
EMP.DDVLK.5095	5000x900x500	8 Filtre / Filters	1.520

Kod Code	Ebatlar Dimension mm	Filtre Filters	Fiyatı Price Euro
EMP.DDVLK.10114	1000x1100x400	1 Filtre / Filters	375
EMP.DDVLK.15114	1500x1100x400	2 Filtre / Filters	505
EMP.DDVLK.20114	2000x1100x400	3 Filtre / Filters	635
EMP.DDVLK.25114	2500x1100x400	4 Filtre / Filters	760
EMP.DDVLK.30114	3000x1100x400	5 Filtre / Filters	890
EMP.DDVLK.35114	3500x1100x400	6 Filtre / Filters	1.130
EMP.DDVLK.40114	4000x1100x400	6 Filtre / Filters	1.260
EMP.DDVLK.45114	4500x1100x400	7 Filtre / Filters	1.390
EMP.DDVLK.50114	5000x1100x400	8 Filtre / Filters	1.515

Kod Code	Ebatlar Dimension mm	Filtre Filters	Fiyatı Price Euro
EMP.DDVLK.10115	1000x1100x500	1 Filtre / Filters	405
EMP.DDVLK.15115	1500x1100x500	2 Filtre / Filters	545
EMP.DDVLK.20115	2000x1100x500	3 Filtre / Filters	680
EMP.DDVLK.25115	2500x1100x500	4 Filtre / Filters	815
EMP.DDVLK.30115	3000x1100x500	5 Filtre / Filters	950
EMP.DDVLK.35115	3500x1100x500	6 Filtre / Filters	1.210
EMP.DDVLK.40115	4000x1100x500	6 Filtre / Filters	1.345
EMP.DDVLK.45115	4500x1100x500	7 Filtre / Filters	1.485
EMP.DDVLK.50115	5000x1100x500	8 Filtre / Filters	1.620

450 - 500 cm ölçülü davlumbazlar iki parçadan oluşmaktadır. // 450 - 500 cm hoods are two pieces.

Kutu Davlumbaz Duvar Tip Filtreli
Wall Type Box Hood With Filters

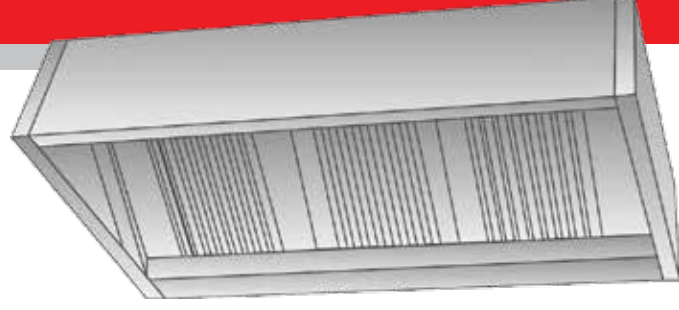
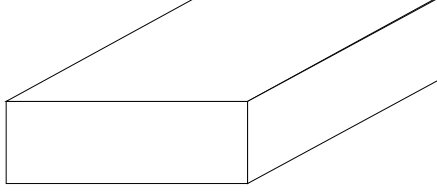

400 Seri / 400 Series

Kod Code	Ebatlar Dimension mm	Filtre Filters	Fiyatı Price Euro
EMP.DDVLD.1094	1000x900x400	1 Filtre / Filters	375
EMP.DDVLD.1594	1500x900x400	2 Filtre / Filters	510
EMP.DDVLD.2094	2000x900x400	3 Filtre / Filters	640
EMP.DDVLD.2594	2500x900x400	4 Filtre / Filters	770
EMP.DDVLD.3094	3000x900x400	5 Filtre / Filters	900
EMP.DDVLD.3594	3500x900x400	6 Filtre / Filters	1.135
EMP.DDVLD.4094	4000x900x400	6 Filtre / Filters	1.270
EMP.DDVLD.4594	4500x900x400	7 Filtre / Filters	1.400
EMP.DDVLD.5094	5000x900x400	8 Filtre / Filters	1.530

500 Seri / 500 Series

Kod Code	Ebatlar Dimension mm	Filtre Filters	Fiyatı Price Euro
EMP.DDVLD.1095	1000x900x500	1 Filtre / Filters	405
EMP.DDVLD.1595	1500x900x500	2 Filtre / Filters	545
EMP.DDVLD.2095	2000x900x500	3 Filtre / Filters	685
EMP.DDVLD.2595	2500x900x500	4 Filtre / Filters	825
EMP.DDVLD.3095	3000x900x500	5 Filtre / Filters	960
EMP.DDVLD.3595	3500x900x500	6 Filtre / Filters	1.220
EMP.DDVLD.4095	4000x900x500	6 Filtre / Filters	1.360
EMP.DDVLD.4595	4500x900x500	7 Filtre / Filters	1.500
EMP.DDVLD.5095	5000x900x500	8 Filtre / Filters	1.640

Kod Code	Ebatlar Dimension mm	Filtre Filters	Fiyatı Price Euro
EMP.DDVLD.10114	1000x1100x400	1 Filtre / Filters	405
EMP.DDVLD.15114	1500x1100x400	2 Filtre / Filters	545
EMP.DDVLD.20114	2000x1100x400	3 Filtre / Filters	685
EMP.DDVLD.25114	2500x1100x400	4 Filtre / Filters	820
EMP.DDVLD.30114	3000x1100x400	5 Filtre / Filters	960
EMP.DDVLD.35114	3500x1100x400	6 Filtre / Filters	1.220
EMP.DDVLD.40114	4000x1100x400	6 Filtre / Filters	1.360
EMP.DDVLD.45114	4500x1100x400	7 Filtre / Filters	1.495
EMP.DDVLD.50114	5000x1100x400	8 Filtre / Filters	1.635

Kod Code	Ebatlar Dimension mm	Filtre Filters	Fiyatı Price Euro
EMP.DDVLD.10115	1000x1100x500	1 Filtre / Filters	440
EMP.DDVLD.15115	1500x1100x500	2 Filtre / Filters	585
EMP.DDVLD.20115	2000x1100x500	3 Filtre / Filters	730
EMP.DDVLD.25115	2500x1100x500	4 Filtre / Filters	880
EMP.DDVLD.30115	3000x1100x500	5 Filtre / Filters	1.025
EMP.DDVLD.35115	3500x1100x500	6 Filtre / Filters	1.305
EMP.DDVLD.40115	4000x1100x500	6 Filtre / Filters	1.455
EMP.DDVLD.45115	4500x1100x500	7 Filtre / Filters	1.600
EMP.DDVLD.50115	5000x1100x500	8 Filtre / Filters	1.745

450 - 500 cm ölçülü davlumbazlar iki parçadan oluşmaktadır. // 450 - 500 cm hoods are two pieces.

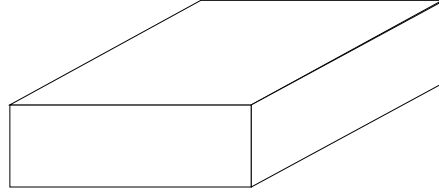
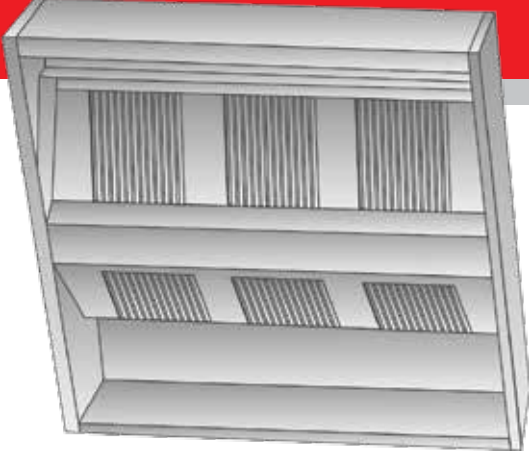
Davlumbaz Orta Tip Filtreli
Central Type Hood With Filters

1970x400 Seri / 1970x400 Series

Kod Code	Ebatlar Dimension mm	Filtre Filters	Fiyatı Price Euro
EMP.ODVL.10194-M	1000x1970x400	2 Filtre / Filters	645
EMP.ODVL.15194-M	1500x1970x400	4 Filtre / Filters	880
EMP.ODVL.20194-M	2000x1970x400	6 Filtre / Filters	1.115
EMP.ODVL.25194-M	2500x1970x400	8 Filtre / Filters	1.350
EMP.ODVL.30194-M	3000x1970x400	10 Filtre / Filters	1.580
EMP.ODVL.35194-M	3500x1970x400	12 Filtre / Filters	1.980
EMP.ODVL.40194-M	4000x1970x400	12 Filtre / Filters	2.215
EMP.ODVL.45194-M	4500x1970x400	14 Filtre / Filters	2.445
EMP.ODVL.50194-M	5000x1970x400	16 Filtre / Filters	2.670

2470x400 Seri / 2470x400 Series

Kod Code	Ebatlar Dimension mm	Filtre Filters	Fiyatı Price Euro
EMP.ODVL.10244-M	1000x2470x400	2 Filtre / Filters	720
EMP.ODVL.15244-M	1500x2470x400	4 Filtre / Filters	975
EMP.ODVL.20244-M	2000x2470x400	6 Filtre / Filters	1.230
EMP.ODVL.25244-M	2500x2470x400	8 Filtre / Filters	1.485
EMP.ODVL.30244-M	3000x2470x400	10 Filtre / Filters	1.740
EMP.ODVL.35244-M	3500x2470x400	12 Filtre / Filters	2.190
EMP.ODVL.40244-M	4000x2470x400	12 Filtre / Filters	2.440
EMP.ODVL.45244-M	4500x2470x400	14 Filtre / Filters	2.700
EMP.ODVL.50244-M	5000x2470x400	16 Filtre / Filters	2.950

450 - 500 cm ölçülü davlumbazlar iki parçadan oluşmaktadır. // 450 - 500 cm hoods are two pieces.

Davlumbaz Orta Tip Filtreli
Central Type hood with Filters

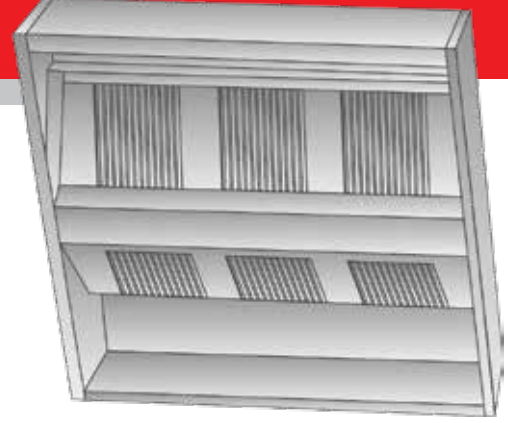
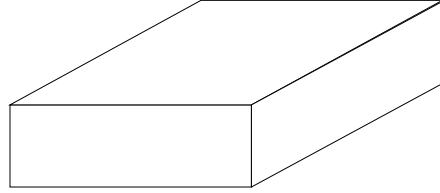

1970x500 Seri / 1970x500 Series

Kod Code	Ebatlar Dimension mm	Filtre Filters	Fiyatı Price Euro
EMP.ODVL.10195-M	1000x1970x500	2 Filtre / Filters	690
EMP.ODVL.15195-M	1500x1970x500	4 Filtre / Filters	935
EMP.ODVL.20195-M	2000x1970x500	6 Filtre / Filters	1.180
EMP.ODVL.25195-M	2500x1970x500	8 Filtre / Filters	1.420
EMP.ODVL.30195-M	3000x1970x500	10 Filtre / Filters	1.665
EMP.ODVL.35195-M	3500x1970x500	12 Filtre / Filters	2.100
EMP.ODVL.40195-M	4000x1970x500	12 Filtre / Filters	2.335
EMP.ODVL.45195-M	4500x1970x500	14 Filtre / Filters	2.580
EMP.ODVL.50195-M	5000x1970x500	16 Filtre / Filters	2.825

450 - 500 cm ölçülü davlumbazlar iki parçadan oluşmaktadır. // 450 - 500 cm hoods are two pieces.

Davlumbaz Orta Tip Filtreli
Central Type hood with Filters

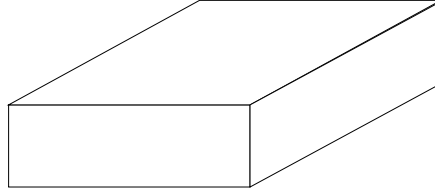
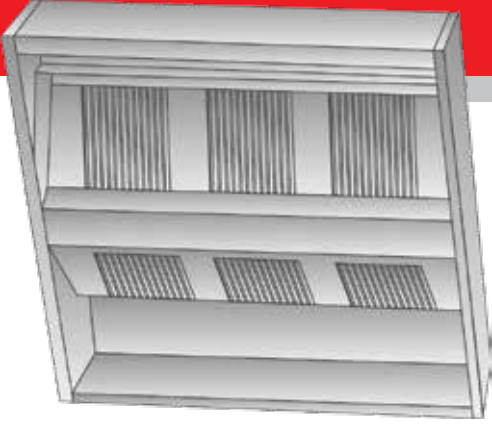

2470x500 Seri / 2470x500 Series

Kod Code	Ebatlar Dimension mm	Filtre Filters	Fiyatı Price Euro
EMP.ODVL.10245-M	1000x2470x500	2 Filtre / Filters	770
EMP.ODVL.15245-M	1500x2470x500	4 Filtre / Filters	1.035
EMP.ODVL.20245-M	2000x2470x500	6 Filtre / Filters	1.300
EMP.ODVL.25245-M	2500x2470x500	8 Filtre / Filters	1.560
EMP.ODVL.30245-M	3000x2470x500	10 Filtre / Filters	1.825
EMP.ODVL.35245-M	3500x2470x500	12 Filtre / Filters	2.320
EMP.ODVL.40245-M	4000x2470x500	12 Filtre / Filters	2.575
EMP.ODVL.45245-M	4500x2470x500	14 Filtre / Filters	2.840
EMP.ODVL.50245-M	5000x2470x500	16 Filtre / Filters	3.100

450 - 500 cm ölçülü davlumbazlar iki parçadan oluşmaktadır. // 450 - 500 cm hoods are two pieces.

İthal Ürünler
Import Products



www.juniorprince.com



Buz Makineleri / / Ice Makers

Şişe Soğutucular / Bottle Coolers

Teşhir Üniteleri-Soğutmalı -Isıtmalı / Display Units - Cold & Hot

Capuccino Espresso Makineleri / Cappucino Espresso Machines

Filtre Kahve ve Sıcak Çikolata Makinesi / Filter Coffee and Hot Chocolate Machine

Katı Meyve Presi - Portakal Sıkma Makinesi / Juice Extractor Citrus Press - Orange Juicer

Şerbet ve Ayran Soğutucu (Yuvarlak Model) / Juice Dispenser (Rounded Type)

Şerbet ve Ayran Soğutucu / Juice Dispenser

**Bar Blenderi (High Power) - Soğan Doğrama Makinesi - Hız Kontrollü Mikser / Bar Blender (High Power) -
Cutter - Speed Controlled Mixer**

Elektrikli Döner Kesme Bıçağı - Çorbalık / Electric Doner Blade - Soup Kettle

Mikrodalga Fırın (Endüstriyel Tip) - İndüksiyon Ocakları / Microwave Oven - Induction Cooker

EI Blenderi / Immersion Blender

Gıda Dilimleme Makinesi / Food Slicer

Elektrikli Fritöz ve Izgaralar / Electrical Fryers & Grill

Tost Makineleri (Elektrikli) / Toaster (Electric)

Termobox-600 - Hamburger Presi / Thermobox-600 - Hamburger Pres

Ön Yıkama Duş Üniteleri / Pre-washing Units

Buz Makineleri Ice Makers



Kod Code	Ürün Adı Description	Ebatlar Dimension mm			Ağırlık Weight kg	Net Net m³	Kapasite Capacity kg	Fiyatı Price Euro
		a	b	c				
JP.30	Buz Makinesi Ice Makers	405x515x750			40	0.16	30	1.850
JP.50	Buz Makinesi Ice Makers	465x595x795			58	0.22	50	2.450
JP.90	Buz Makinesi Ice Makers	715x595x945			69	0.4	90	3.300
JP.125	Buz Makinesi Ice Makers	715x700x1050			89	0.53	125	3.850
JP.175	Buz Makinesi Ice Makers	860x700x1050			95	0.63	175	4.250
JP.250	Buz Makinesi (Alt Hazne Dahil) Ice Makers (Bin Included)	762x819x1571			135	0.98	250	6.500
JP.450	Buz Makinesi (Alt Hazne Dahil) Ice Makers (Bin Included)	762x819x1831			155	1.14	450	8.200

Türkçe

BUZ MAKİNELERİ

JP.30

- 30 kg buz kapasitesi.
- 15 kg depo haznesi.
- Alüminyum panelli bakır borulu evaporatör.
- Kayar kapı.
- Paslanmaz çelik gövde.

JP.50

- 50 kg buz kapasitesi.
- 20 kg depo haznesi.
- Alüminyum panelli bakır borulu evaporatör.
- Kayar kapı.
- Paslanmaz çelik gövde.

JP.90

- 90 kg buz kapasitesi.
- 35 kg depo haznesi.
- Alüminyum panelli bakır borulu evaporatör.
- Kayar kapı.
- Paslanmaz çelik gövde.

JP.125

- 125 kg buz kapasitesi.
- 60 kg depo haznesi.
- Alüminyum panelli bakır borulu evaporatör.
- Kayar kapı.
- Paslanmaz çelik gövde.

JP.175

- 175 kg buz kapasitesi.
- 75 kg depo haznesi.
- Alüminyum panelli bakır borulu evaporatör.
- Kayar kapı.
- Paslanmaz çelik gövde.

JP.250

- 250 kg buz kapasitesi.
- 200 kg depo haznesi.
- Alüminyum panelli bakır borulu evaporatör.
- Paslanmaz çelik gövde.

JP.450

- 450 kg buz kapasitesi.
- 200 kg depo haznesi.
- Alüminyum panelli bakır borulu evaporatör.
- Paslanmaz çelik gövde.

English

ICE MAKERS

JP.30

- Production Capacity:30 kg/day
- Bin capacity:15 kg
- Evaporator with aluminium panel and copper pipe.
- Sliding door.
- Stainless steel body.

JP.50

- Production Capacity:50 kg/day
- Bin capacity:20 kg
- Evaporator with aluminium panel and copper pipe.
- Sliding door.
- Stainless steel body.

JP.90

- Production Capacity: 90 kg/day
- Bin capacity:35 kg
- Evaporator with aluminium panel and copper pipe.
- Sliding door.
- Stainless steel body.

JP.125

- Production Capacity: 125 kg/day
- Bin capacity:60 kg
- Evaporator with aluminium panel and copper pipe.
- Sliding door.
- Stainless steel body.

JP.175

- Production Capacity: 175 kg/day
- Bin capacity:75 kg
- Evaporator with aluminium panel and copper pipe.
- Sliding door.
- Stainless steel body.

JP.250

- Production Capacity: 250 kg/day
- Bin capacity:200 kg
- Evaporator with aluminium panel and copper pipe.
- Stainless steel body.

JP.450

- Production Capacity: 450 kg/day
- Bin capacity:200 kg
- Evaporator with aluminium panel and copper pipe.
- Stainless steel body.



JP.250 - JP.450

Şişe Soğutucular Bottle Coolers



Kod Code	Ürün Adı Description	Ebatlar Dimension mm			Ağırlık Weight kg	Güç Power kw	Kapasite Capacity lt	Fiyatı Price Euro
		a	b	c				
JP.SS.2	Şişe Soğutucular (2 Kapılı) Bottle Coolers (2 Doors)	920x500x870			42	0.26	-	990



Kod Code	Ürün Adı Description	Ebatlar Dimension mm			Ağırlık Weight kg	Güç Power kw	Kapasite Capacity lt	Fiyatı Price Euro
		a	b	c				
JP.SS.3	Şişe Soğutucular (3 Kapılı) Bottle Coolers (3 Doors)	1380x500x870			52	0.30	-	1.150

Türkçe

ŞİŞE SOĞUTUCULAR

- 220 V-230 V -1 +N -50 60 Hz elektrik gücü.
- PVC kaplı galvaniz sac.
- CFC Free soğutma gazı: R 134A / R 404A
- Dış ortam sıcaklığı: +32 °C
- Fanlı soğutma.
- Dijital termometre & termostat.
- Otomatik defrost.
- Kapılarda kilit.
- Özel kapı menteşe sistemi.
- Temizlenebilir ve sökülebilir manyetik kapı contası.

English

BOTTLE COOLERS

- 220 V-230 V -1 +N -50 60 Hz electrical power.
- PVC coated galvanized steel.
- "CFC Free" refrigerant gas: R 134A / R 404 A
- + 32 °C ambient temp.
- Fan cooling.
- Digital thermometer and thermostat.
- Automatic defrosting.
- Lock system in the door.
- Special door hinge system.
- Removable and easy to clean magnetic door.



Teşhir Üniteleri-Soğutmalı ve Isıtmalı Display Units - Cold & Hot

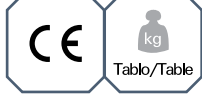

Kod Code	Ürün Adı Description	Ebatlar Dimension mm			Ağırlık Weight kg	Güç Power kw	Net Net m³	Kapasite Capacity lt	Fiyatı Price Euro
		a	b	c					
JP.120.S	Teşhir Ünitesi-Soğutmalı Display Unit - Cold	702	568	686	64	0.16	0.20	120	1.045



Kod Code	Ürün Adı Description	Ebatlar Dimension mm			Ağırlık Weight kg	Güç Power kw	Net Net m³	Kapasite Capacity lt	Fiyatı Price Euro
		a	b	c					
JP.160.S	Teşhir Ünitesi-Soğutmalı Display Unit - Cold	880	568	686	71	0.16	0.30	160	1.155



Kod Code	Ürün Adı Description	Ebatlar Dimension mm			Ağırlık Weight kg	Güç Power kw	Net Net m³	Kapasite Capacity lt	Fiyatı Price Euro
		a	b	c					
JP.120.I	Teşhir Ünitesi-Isıtmalı Display Unit - Hot	678	578	670	48	1.1	0.20	120	770



Kod Code	Ürün Adı Description	Ebatlar Dimension mm			Ağırlık Weight kg	Güç Power kw	Net Net m³	Kapasite Capacity lt	Fiyatı Price Euro
		a	b	c					
JP.160.I	Teşhir Ünitesi-Isıtmalı Display Unit - Hot	857	578	670	56	1.5	0.30	160	880



Türkçe

TEŞHİR ÜNİTESİ-SOĞUTMALI

- 220V / 50hz elektrik gücü.
- Çalışma aralığı 0°C + 12°C
- R-134 A soğutucu gaz.
- Led aydınlatma.
- Çift cam.
- Ayarlanabilir 2 adet raf.
- Dijital sıcaklık kontrolü.

TEŞHİR ÜNİTESİ-ISITMALI

- 220 V - 50Hz. Enerji.
- Led aydınlatma.
- Ayarlanabilir isi kontrol.
- Ayarlanabilir 3 adet raf.

English

DISPLAY UNIT - COLD

- 220V / 50hz electrical power.
- Working temperature: 0°C + 12°C
- R-134 A refrigerant gas.
- Led lighting system.
- Double glass.
- 2 adjustable shelves.
- Digital temperature control.

DISPLAY UNIT - HOT

- 220 V - 50Hz. Energy.
- Led lighting system.
- Thermostatic control.
- 3 adjustable shelves

Capuccino Espresso Makineleri

Cappuccino Espresso Machines



Kod Code	Ürün Adı Description	Ebatlar Dimension mm			Ağırlık Weight kg	Net Net m³	Kapasite Capacity (lt)	Fiyatı Price Euro
		a	b	c				
JP.CPC.2G	Capuccino ve Espresso Makinesi 2 Gruplu Capuccino Espresso Machines 2 Groups	710x545x528			72.5	0.20	10.5	3.100



Kod Code	Ürün Adı Description	Ebatlar Dimension mm			Ağırlık Weight kg	Net Net m³	Kapasite Capacity (lt)	Fiyatı Price Euro
		a	b	c				
JP.CPC.3G	Capuccino ve Espresso Makinesi 3 Gruplu Capuccino Espresso Machines 3 Groups	1000x565x560			110	0.20	17	3.800



Kod Code	Ürün Adı Description	Ebatlar Dimension mm			Ağırlık Weight kg	Net Net m³	Kapasite Capacity (lt)	Fiyatı Price Euro
		a	b	c				
JP.CCG.01	Kahve Değirmeni Coffee Grinder	210x380x600			9	0.04	2	450

Kod Code	Ürün Adı Description	Ebatlar Dimension mm			Ağırlık Weight kg	Net Net m³	Kapasite Capacity (lt)	Fiyatı Price Euro
		a	b	c				
JP.SF.01	Su Filtresi Water Filters	230x230x520			6	0.2	12	200

Türkçe

CAPUCCINO ESPRESSO MAKİNELERİ

JP.CPC.2G

- 230 V. çalışma gücü
- Çift buhar kolu.
- Dozaj ayar ünitesi.
- 2 adet çiftli filtre.
- 10,5 lt kazan kapasitesi.
- Ekstra sıcak su kolu.
- Yarı otomatik.

JP.CPC.3G

- 230 V. çalışma gücü.
- Çift buhar kolu.
- Dozaj ayar ünitesi.
- 3 adet filtre.
- 17 lt kazan kapasitesi.
- Ekstra sıcak su kolu.
- Yarı otomatik.

JP.CCG.01

- 230 V - 356 W- 1.75 A.
- Termal koruyuculu motor ekipmanı.
- Maksimum çalışma süresi 30 dk.
- Değirmen çapı 60 mm.
- Hazne kapasitesi 2 kg.
- Dispenser kapasitesi ortalama 2 kg.

English

CAPPUCCINO ESPRESSO MACHINES

JP.CPC.2G

- 230 V operating voltage.
- Double steam arm.
- Dosage adjustment unit.
- 2 double filter handles.
- 10.5 liter boiler capacity.
- Extra-warm water arm.
- Semi automatic.

JP.CPC.3G

- 230 V operating voltage.
- Double steam arm.
- Dosage adjustment unit.
- 3 double filter handles.
- 17 liter boiler capacity.
- Extra-warm water arm.
- Semi automatic.

JP.CCG.01

- 230 V - 356 W-1.75 A
- Thermal motor protection equipment.
- Maximum operating time 30 minutes.
- Mill diameter of 60 mm
- Bin capacity 2 kg
- Dispenser average of 2 kg capacity.

Filtre Kahve ve Sıcak Çikolata Makinesi

Filter Coffee and Hot Chocolate Machine



Kod Code	Ürün Adı Description	Ebatlar Dimension mm			Ağırlık Weight kg	Güç Power kw	Net Net m³	Kapasite Capacity lt	Fiyatı Price Euro
		a	b	c					
JP.FK.01	Filtre Kahve Makinesi Filter Coffee Machine	205	410	450	6	1.96	0.04	1.7	385



Kod Code	Ürün Adı Description	Ebatlar Dimension mm			Ağırlık Weight kg	Güç Power kw	Net Net m³	Kapasite Capacity lt	Fiyatı Price Euro
		a	b	c					
JP.SC.01	Sıcak Çikolata Makinesi Hot Chocolate Machine	410	280	580	3	1	0.06	10	605



Türkçe

FİLTRE KAHVE MAKİNESİ

- 220 V. 50 Hz. enerji.
- 5 dakika içinde kaynatma süresi.
- Tank kapasitesi: 1,7 Litre.
- Cezve kapasitesi: 1,7 Litre

SICAK ÇİKOLATA MAKİNESİ

- 220 V. 50 Hz. enerji.
- 0°- 85° C termostat kontrol ünitesi.

English

FILTER COFFEE MACHINE

- 220 V. 50 Hz energy.
- Boiling time: 5 minute.
- Tank Capacity: 1,7 Litre.
- Pot Capacity: 1,7 Litre.

HOT CHOCOLATE MACHINE

- 220 V. 50 Hz energy.
- 0°- 85° C Thermostat control unit.



Katı Meyve Presi - Portakal Sıkma Makineleri

Juice Extractor Citrus Press - Orange Juicers



Kod Code	Ürün Adı Description	Ebatlar Dimension mm			Ağırlık Weight kg	Güç Power kw	Net Net m³	Kapasite Capacity lt	Fiyatı Price Euro
		a	b	c					
JP.KM.01	Katı Meyve Presi Juice Extractor Citrus Press	205	310	360	4	0.03	0.04	1	425



Kod Code	Ürün Adı Description	Ebatlar Dimension mm			Ağırlık Weight kg	Güç Power kw	Net Net m³	Kapasite Capacity lt	Fiyatı Price Euro
		a	b	c					
JP.PR.01	Portakal Sıkma Makinesi Orange Juicer	260	254	470	9	0.18	0.03	220	245



Kod Code	Ürün Adı Description	Ebatlar Dimension mm			Ağırlık Weight kg	Güç Power kw	Net Net m³	Kapasite Capacity lt	Fiyatı Price Euro
		a	b	c					
JP.PR.02	Portakal Sıkma Makinesi (Paslanmaz Çelik) Orange Juicer (Stainless Steel)	280	200	470	9	0.23	0.03	340	375



Kod Code	Ürün Adı Description	Ebatlar Dimension mm			Ağırlık Weight kg	Güç Power kw	Net Net m³	Kapasite Capacity lt	Fiyatı Price Euro
		a	b	c					
JP.PR.03	Portakal Sıkma Makinesi (Manuel) Manuel Citrus Juicer	200	240	500	6		0.02	110	120

Türkçe

KATI MEYVE PRESİ

- 220-240 V - 430W. motor gücü.
- Otomatik posa atım sistemi.
- Turbo düğmesi.
- 6300 d/dk
- Paslanmaz çelik gövde.

PORTAKAL SIKMA MAKİNELERİ

JP.PR.01

- 220 V-1800 d/dk devir gücü.
- Sessiz,yüksek performanslı,enerji tasarruflu çalışma imkanı.
- Paslanmaz çelik gövde.

JP.PR.02

- 220 V-980 d/dk devir gücü.
- Sessiz,yüksek performanslı,enerji tasarruflu çalışma imkanı.
- Paslanmaz çelik gövde ve sıcakcak haznesi.

English

JUICE EXTRACTOR CITRUS PRESS

- Motor power: 220-240 V - 430W
- Automatic pulp ejection.
- Turbo button.
- 6300 circuit per a minute.
- Stainless steel body.

ORANGE JUICERS

JP.PR.01

- 220 V-1800 rpm motor power.
- Energy saving usage with silent operation.
- Stainless steel body.

JP.PR.02

- 220 V-980 rpm motor power.
- Energy saving usage with silent operation.
- Stainless steel body on top reservoir.

Şerbet ve Ayran Soğutucu (Yuvarlak Model) Juice Dispenser (Rounded Type)



Kod Code	Ürün Adı Description	Ebatlar Dimension mm			Ağırlık Weight kg	Net Net m³	Kapasite Capacity lt	Fiyatı Price Euro
		a	b	c				
JP.SY.22	Şerbet ve Ayran Soğutucu Juice Dispenser	752x395x400			21	0.12	22	875



Kod Code	Ürün Adı Description	Ebatlar Dimension mm			Ağırlık Weight kg	Net Net m³	Kapasite Capacity lt	Fiyatı Price Euro
		a	b	c				
JP.SY.40	Şerbet ve Ayran Soğutucu Juice Dispenser	752x395x400			21	0.12	40	1.150



Türkçe

ŞERBET VE AYRAN SOĞUTUCU (YUVARLAK MODEL)

- 220 V. 50 Hz. çalışma gücü.
- r134A Soğutucu gaz.
- Tabandan soğutma sistemi ile içeceği son damlasına kadar eşit olarak soğutma.
- Dijital termostat ve soğutma sistemi sayesinde %15 enerji tasarrufu.
- Dijital termostat kontrol.
- +3 ile +10 derece arasında sıcaklık.
- Su sızması ve motora su kaçma riski ortadan kaldıran manyetik karıştırma sistemi.
- Geniş musluk hortumu.
- Düşük çalışma ses seviyesi.
- Hazne kapağının düz formu sayesinde bardaklık olarak kullanılabile imkanı.
- İçecek ile temas eden tüm parçalar kolaylık çıkarılabilir ve temizlenebilir.

English

JUICE DISPENSER (ROUNDED TYPE)

- 220 V. 50 Hz operating power.
- R134A Refrigerant gas.
- Floor-cooling system with cools evenly until the last drop of drink.
- The digital thermostat and cooling system provides a 15% energy savings.
- It shows the current temperature of the drink with digital thermostat.
- Beverage temperature can be adjusted +3 and +10 degrees between.
- With one hand, the developed system makes it easier to tap beverage intake.
- With magnetic mixing system eliminates the risk of water leakage into the water leakage and engine.
- The low noise level of the class.
- Possibility to use the cup holder thanks to the flat form of the hopper cover.
- All parts in contact with the beverage removable and can be cleaned with ease.

Şerbet ve Ayran Soğutucu Juice Dispenser



Kod Code	Ürün Adı Description	Ebatlar Dimension mm			Ağırlık Weight kg	Net Net m³	Kapasite Capacity lt	Fiyatı Price Euro
		a	b	c				
JP.SK.20	Şerbet ve Ayran Soğutucu Juice Dispenser	700x185x520			21	0.07	20	665



Kod Code	Ürün Adı Description	Ebatlar Dimension mm			Ağırlık Weight kg	Net Net m³	Kapasite Capacity lt	Fiyatı Price Euro
		a	b	c				
JP.SK.40	Şerbet ve Ayran Soğutucu Juice Dispenser	700x365x520			31	0.13	20x2	1.000



Kod Code	Ürün Adı Description	Ebatlar Dimension mm			Ağırlık Weight kg	Net Net m³	Kapasite Capacity lt	Fiyatı Price Euro
		a	b	c				
JP.SK.60	Şerbet ve Ayran Soğutucu Juice Dispenser	700x545x520			42	0.19	20x3	1.400

Türkçe

ŞERBET VE AYRAN SOĞUTUCU

- 220 V. 50 Hz. çalışma gücü.
- r134A Soğutucu gaz.
- Tabandan soğutma sistemi ile içeceği son damlasına kadar eşit olarak soğutma.
- Dijital termostat ve soğutma sistemi sayesinde %15 enerji tasarrufu.
- Dijital termostat kontrol.
- +5 ile +10 derece arasında sıcaklık.
- Su sızması ve motora su kaçma riski ortadan kaldıran manyetik karıştırma sistemi.
- Geniş musluk hortumu.
- Düşük çalışma ses seviyesi.
- Hazne kapağının düz formu sayesinde bardaklık olarak kullanabilme imkanı.
- İçecek ile temas eden tüm parçalar kolaylık çıkarılabilir ve temizlenebilir.

English

JUICE DISPENSER

- 220 V. 50 Hz operating power.
- R134A Refrigerant gas.
- Super strong, virtually unbreakable polycarbonate bowls and covers. 20
- Litre Bowl Capacity.
- Removable Bowl and Cover.
- Due to the large hose threaded tap it provides fluidity even in beverages.
- Electromagnetic pump and silent stirring motor.
- Stainless Steel Sides.
- Unique evaporator and faster start up.
- Better design allow easier cleaning and less maintenance .

Bar Blenderi (High Power) - Soğan Doğrama Makinesi - Hız Kontrollü Mikser

Bar Blender (High Power) - Cutter - Speed Controlled Mixer



Kod Code	Ürün Adı Description	Ebatlar Dimension mm			Ağırlık Weight kg	Güç Power kw	Net Net m³	Kapasite Capacity lt	Fiyatı Price Euro
		a	b	c					
JP.BB.01	Bar Blenderi Bar Blender	200	225	511	5	1.5	0.02	2	330

Buz kırabilme özelliği
Ice crusher blender



Kod Code	Ürün Adı Description	Ebatlar Dimension mm			Ağırlık Weight kg	Güç Power kw	Net Net m³	Kapasite Capacity lt	Fiyatı Price Euro
		a	b	c					
JP.SD.01	Soğan Doğrama Makinesi Cutter	490	265	335	18	0.37	7.5	330	330



Kod Code	Ürün Adı Description	Ebatlar Dimension mm			Ağırlık Weight kg	Güç Power kw	Net Net m³	Kapasite Capacity lt	Fiyatı Price Euro
		a	b	c					
JP.MK.107	Hız Kontrollü Mikser Speed Controlled	400	250	410	17	0.35	0.04	7	660



Türkçe

BAR BLENDERİ

- 220V.50-60 Hz çalışma gücü.
- Çelik dişli.
- **Titanyum bıçak.**

SOĞAN DOĞRAMA MAKİNESİ

- 0,37 kw 2800 d/dk 220 v.motor gücü.
- 260mm tencere çapı. 150 mm tencere derinliği.
- Paslanmaz çelik kazan.

HIZ KONTROLLÜ MİKSER

- 220V.50Hz Enerji.
- Çıkarılabilir paslanmaz çelik kazan.
- Hijyenik ve emniyetli kullanım.
- 1 adet çırpma teli.
- 1 adet hamur baltası.
- 1 adet çırpma paleti.

English

BAR BLENDER

- 220V.50-60 Hz operating voltage.
- Steel gearwheel.
- **Titanium blade**

CUTTER

- Motor power:0.37 Kw 2800 D/Dk-220 V
- Bowl dimension (diameter/depth) 260/150 mm
- Stainless steel body.

SPEED CONTROLLED MIXER

- 220V.50Hz Energy.
- Removable stainless steel tank.
- Safety switch and hygienic usage.
- 1 Of Whisk.
- 1 Of Dough hook.
- 1 Of Mixing Paddle.

Elektrikli Döner Kesme Bıçağı - Çorbalık Electric Doner Blade - Soup Kettle



Kod Code	Ürün Adı Description	Ebatlar Dimension mm			Ağırlık Weight kg	Güç Power kw	Net Net m³	Fiyatı Price Euro
		a	b	c				
JP.100E	Elektrikli Döner Kesme Bıçağı Electric Doner Blade	113x190x150			3	0.23	0.05	550
JP.D.01	Düz Bıçak Smooth Blade	Ø10						30
JP.T.01	Tırtırlı Bıçak Knurled Blade	Ø10						35



Kod Code	Ürün Adı Description	Ebatlar Dimension mm			Ağırlık Weight kg	Güç Power kw	Net Net m³	Kapasite Capacity lt	Fiyatı Price Euro
		a	b	c					
JP.CRP.01-P	Çorbalık - Paslanmaz Gövdeli Soup Kettle Stainless Steel Body	360x355x200			17	0.4	0.03	10	160



Kod Code	Ürün Adı Description	Ebatlar Dimension mm			Ağırlık Weight kg	Güç Power kw	Net Net m³	Kapasite Capacity lt	Fiyatı Price Euro
		a	b	c					
JP.CRP.01	Çorbalık Soup Kettle	360x400x200			18	0.4	0.03	8	125

Türkçe

ÇORBALIK

- 220V.50 Hz çalışma gücü.
- Çıkarılabilir paslanmaz çelik iç hazne.
- Hijyenik ve emniyetli kullanım.

ELEKTRİKLİ DÖNER KESME BIÇAĞI

- 220 V - 2200 d/dk motor gücü.
- Bıçak çapı: 100 mm
- Kesme kalınlığı: 0 ~ 8 mm
- Bıçak bileme aparatı.

English

SOUP KETTLE

- 220V.50 Hz operating voltage.
- Removable stainless steel reservoir.
- Hygienic and safe usage.

ELECTRIC DONER BLADE

- Motor power: 2200 rpm 220 V
- Blade diameter: 100 mm
- Cutting thickness: 0 ~ 8 mm
- Blade sharpening tool

Mikrodalga Fırın (Endüstriyel Tip) - İndüksiyon Ocakları Microwave Oven (Industrial Type) - Induction Cookers



Kod Code	Ürün Adı Description	Ebatlar Dimension mm			Ağırlık Weight kg	Güç Power kw	Net Net m³	Fiyatı Price Euro
		a	b	c				
JP.MD.01	Mikrodalga Fırın Microwave Oven	511x421x285			25	1	0.06	440



Kod Code	Ürün Adı Description	Ebatlar Dimension mm			Ağırlık Weight kg	Güç Power kw	Net Net m³	Fiyatı Price Euro
		a	b	c				
JP.ID.01	İndüksiyon Ocağı Induction Cooker	340x440x120			8	0.5 - 3	0.02	385



Kod Code	Ürün Adı Description	Ebatlar Dimension mm			Ağırlık Weight kg	Güç Power kw	Net Net m³	Fiyatı Price Euro
		a	b	c				
JP.IDW.02	İndüksiyon Ocağı (Wok) Induction Cooker (Wok)	340x440x120			8	0.5 - 3	0.02	410



Türkçe

MİKRODALGA FIRIN

- 220 V. 50 Hz enerji
- 25 lt kapasite.
- Dokunmatik-Led ışıklı kontrol ekranı.
- Paslanmaz çelik iç ve dış çerçeve.
- Farklı çalışma seviyeleri.
- 10- 8 dk ayarlı zamanlayıcı

İNDÜKSİYON OCAĞI

- 220 V / 50 Hz. enerji
- Seramik tabla.
- Zaman ayarlı kontrol panosu.

English

MICROWAVE OVEN

- 220 V. 50 Hz operating voltage.
- Capacity: 25 lt
- Touch screen LCD control panel.
- Stainless steel interior and out frame.
- Different levels of operating.
- Timer: 10- 8 minute.

INDUCTION COOKER

- 220 V / 50 Hz. energy.
- Ceramic pleyt.
- Control panel with timer.

El Blenderleri Immersion Blender



Kod Code	Ürün Adı Description	Ebatlar Dimension mm		Ağırlık Weight kg	Net Net m ³	Güç Power kw	Kapasite Capacity lt	Fiyatı Price Euro
		a	b					
JP.BLE.01	El Blenderi 30 cm (Çırpıcı ve Kesici) Immersion Blender 30cm (Whisk Tool and Cutter)	97x640		3.4	0.02	300	20-40	600
JP.BLE.02	El Blenderi 50 cm (Çırpıcı ve Kesici) Immersion Blender 50cm (Whisk Tool and Cutter)	122x760		4.5	0.04	460	20-100	750

Türkçe

EL BLENDERİ

JP.BLE.01

- Toplam Uzunluğu: 640 mm
- Mikser Uzunluğu: 205 mm
- Kesici Uzunluğu: 300 mm
- Motor Gücü: 300 Watt
- Motor Devri(Mikser):0-9500 devir/dak
- Motor Devri(Kesici):0-900 devir/dak
- Blender Kapasitesi:20-40 lt
- Mikser Kapasitesi:5-20 lt

JP.BLE.02

- Toplam Uzunluğu: 760 mm
- Mikser Uzunluğu: 245 mm
- Kesici Uzunluğu: 410 mm
- Motor Gücü: 460 Watt
- Motor Devri(Mikser):3000-9500 devir/dak
- Motor Devri (Kesici):300-900 devir/dak
- Blender Kapasitesi:40-100 lt
- Mikser Kapasitesi:10-20 lt.

English

IMMERSION BLENDER

JP.BLE.01

- Total Length: 640 mm
- Mixer Length: 205 mm
- Whisk Length: 300 mm
- Motor Power: 300 Watt
- Mixer Speed:0-9500 rpm
- Whisk Speed:0-900 rpm
- Mixer Capacity:20-40 lt
- Whisk Capacity:5-20 lt.

JP.BLE.02

- Total Length: 760 mm
- Mixer Length: 245 mm
- Whisk Length: 410 mm
- Motor Power: 460 Watt
- Mixer speed:3000-9500 rpm
- Whisk Speed : 300 to 900 rpm
- Mixer Capacity:40-100 lt
- Whisk Capacity:10-20 lt

Çırpıcı ve kesici fiyatlara dahildir.
Whisk tool and cutter included in the price.



Motor
Motor



Çırpıcı
Whisk Tool



Kesici
Cutter

Gıda Dilimleme Makinesi Food Slicer



Kod Code	Ürün Adı Description	Ebatlar Dimension mm			Ağırlık Weight kg	Güç Power kw	Net Net m³	Bıçak Çapı Diameter mm	Fiyatı Price Euro
		a	b	c					
JP.GD.220	Gıda Dilimleme Makinesi Food Slicer	410x400x350			12	0.21	0.06	220	525
JP.GD.250	Gıda Dilimleme Makinesi Food Slicer	535x475x490			16	0.24	0.12	250	600
JP.GD.300	Gıda Dilimleme Makinesi Food Slicer	575x412x460			16	0.27	0.11	300	880

Türkçe

GIDA DİLİMLEME MAKİNESİ

- 220 V-50 Hz Elektrik bağlantısı.
- Hijyenik ve paslanmaz gövde.
- Anodiz alüminyumdan imal.
- Bıçak bileme aparatı.
- Ayarlanabilir kesme kalınlığı.

English

FOOD SLICER

- 220 V-50 Hz Electrical connection.
- Hygienic and stainless steel body.
- Manufactured by anodised aluminium.
- Blade sharpener tool.
- Adjustable slice thickness.



Elektrikli Fritöz ve Izgaralar
 Electrical Fryers & Grill

Kod Code	Ürün Adı Description	Ebatlar Dimension mm			Ağırlık Weight kg	Güç Power kw	Net Net m³	Kapasite Capacity lt	Fiyatı Price Euro
		a	b	c					
JP.FE.01	Elektrikli Fritöz-Tekli Electrical Fryers - Single	290	550	360	5	2.3	0,57	6	280



Kod Code	Ürün Adı Description	Ebatlar Dimension mm			Ağırlık Weight kg	Güç Power kw	Net Net m³	Kapasite Capacity lt	Fiyatı Price Euro
		a	b	c					
JP.FE.02	Elektrikli Fritöz-Çiftli Electrical Fryers - Double	580	550	360	10	2.3x2	1,15	6+6	550



Kod Code	Ürün Adı Description	Ebatlar Dimension mm			Ağırlık Weight kg	Güç Power kw	Net Net m³	Kapasite Capacity lt	Fiyatı Price Euro
		a	b	c					
JP.IE.01	Elektrikli Izgara-Düz Electric Grill - Smooth	550	430	240	14	3	0.5		165



Kod Code	Ürün Adı Description	Ebatlar Dimension mm			Ağırlık Weight kg	Güç Power kw	Net Net m³	Kapasite Capacity lt	Fiyatı Price Euro
		a	b	c					
JP.IE.02	Elektrikli Izgara-Düz Electric Grill - Smooth	730	470	240	25	4.4	0.82		245



Kod Code	Ürün Adı Description	Ebatlar Dimension mm			Ağırlık Weight kg	Güç Power kw	Net Net m³	Kapasite Capacity lt	Fiyatı Price Euro
		a	b	c					
JP.IE.03	Elektrikli Izgara-Düz+Oluklu Electric Grill - Smooth +Ribbed	730	470	240	25	4.4	0.82		285

Türkçe
ELEKTRİKLİ FRITÖZLER

- 220 V-50 HZ Enerji.
- Tahliye Vanaları.
- Paslanmaz Çelik Gövde.

ELEKTRİKLİ IZGARALAR

- 220 V-50 Hz Elektrik Bağlantısı.
- Paslanmaz çelik gövde.

English
ELECTRICAL FRYERS

- 220 V-50 Hz Energy.
- Drainage valve.
- Stainless steel body.

ELECTRIC GRILL

- 220 V-50 Hz Electric energy.
- Stainless steel body.

Tost Makineleri (Elektrikli)

Toaster (Electric)



Kod Code	Ürün Adı Description	Ebatlar Dimension mm			Ağırlık Weight kg	Güç Power kw	Net Net m³	Fiyatı Price Euro
		a	b	c				
JP.TM.01	Tost Makinesi-Blok Toaster (Block)	435x410x210			19	2.2	0.37	275



Kod Code	Ürün Adı Description	Ebatlar Dimension mm			Ağırlık Weight kg	Güç Power kw	Net Net m³	Fiyatı Price Euro
		a	b	c				
JP.TM.02	Tost Makinesi-Çiftli Toaster (Double)	570x395x210			25	3.6	0.47	425



Türkçe

TOST MAKİNELERİ (ELEKTRİKLİ)

- 220V 50 Hz enerji.
- Izgara olarak kullanılabile özelliği.
- Hijyenik ve emniyetli.
- Paslanmaz çelik gövde.

English

TOASTER (ELECTRIC)

- 220V 50 Hz energy.
- Capable to operate as a grill.
- Hygienic and safe.
- Stainless steel body.

Termobox-600 - Hamburger Presi

Thermobox-600 - Hamburger Press



Kod Code	Ürün Adı Description	Ebatlar Dimension mm			Ağırlık Weight kg	Güç Power kw	Net Net m ³	Kapasite Capacity lt	Fiyatı Price Euro
		a	b	c					
JP.HM.01	Hamburger Presi Hamburger Press	275	220	295	8		0.22		220

Kod Code	Ürün Adı Description	Ebatlar Dimension mm			Ağırlık Weight kg	Net Net m ³	Uzunluk Length mt	Fiyatı Price Euro
		a	b	c				
JP.TMB.600	Termobox-600 Thermobox-600	465	610	630	15	0.18	200	200
JP.TMB.600-K	Termobox-600 (Kilitli) Thermobox-600 (Locker)	465	610	630	15	0.18	215	215

Türkçe

HAMBURGER PRESİ

- 130 mm et kesme kalınlığı.
- Paslanmaz çelik gövde.

TERMOBOX

JP.TMB.600

- Gri, kahve, haki, mavi, siyah renk seçenekleri.
- 38-40 kg / m³ poliüretan enjekte edilmiş çift cidarlı gövde.
- Dayanıklılığı arttıran monoblok gövde.
- Kırılmaz PA6 kilitlet.
- -40° C soğuğa +100° C sığağa kadar dayanıklılık.
- 4 saat içerisinde;
- sıcak yemeklerde saatte ortalama 1.5° C ısı kaybı, soğuk yemeklerde ise 1° C ısınma.
- JP.TMB.600 kapasitesi:
- 12 x GN 1/1 -20
- 6 x GN 1/1 -65
- 4 x GN 1/1 -100
- 3 x GN 1/1 -150
- 2 x GN 1/1 -200

English

HAMBURGER PRESS

- Meat thickness:130 mm
- Stainless steel body.

THERMOBOX

JP.TMB.600

- Grey, brown, khaki, blue, black colour options.
- Double jacket enjected with 38-40 kg / m³ polyurethane density.
- Monoblock body provides durable usage.
- Unbreakable PA6 lockers.
- Durable between -40° C +100° C
- 1.5° C loss of heat for hot foods, 1° C heat gain for cold foods per hour in 4 hours.
- Capacity for JP.TMB.600:
- 12 x GN 1/1 -20
- 6 x GN 1/1 -65
- 4 x GN 1/1 -100
- 3 x GN 1/1 -150
- 2 x GN 1/1 -200

Ön Yıkama Duş Üniteleri Pre-washing Units

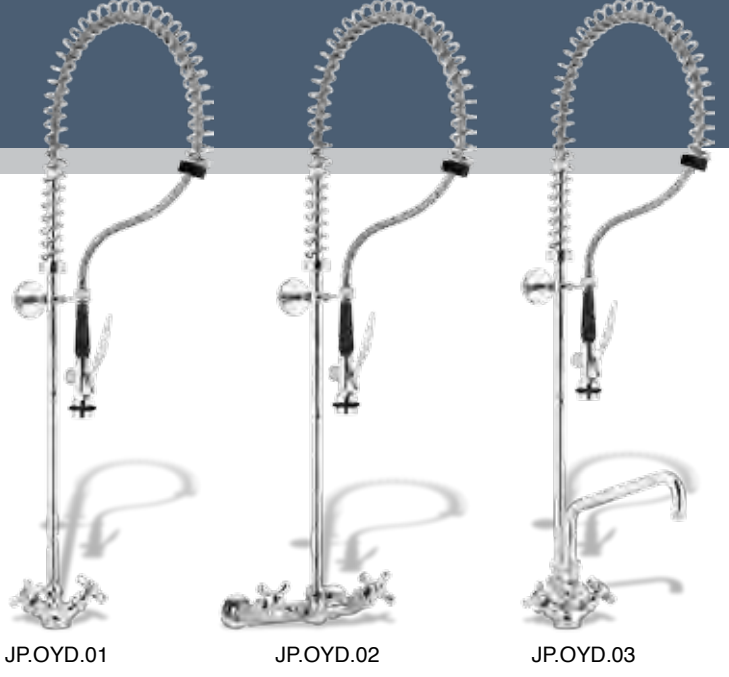

Kod Code	Ürün Adı Description	Fiyatı Price Euro
JP.OYD.01	Ön Yıkama Duşu (Tezgaha Monte) Counter Mounted Pre-washing Unit	195
JP.OYD.02	Ön Yıkama Duşu (Duvara Monte) Wall Mounted Pre-washing Unit	225
JP.OYD.03	Ön Yıkama Duşu (Armatürlü Tezgaha Monte) Counter Mounted Pre-wash Spray Unit with Double Batteries	240

Türkçe

ÖN YIKAMA DUŞ ÜNİTELERİ

- Lekesiz yıkama özelliği.
- Kontrollü basınç sistemi.
- Dayanıklı yapı.

English

PRE-WASHING UNITS

- Spotless washing.
- Controlled pressure system.
- Durable structure.

Teknik Servis Listesi

Sıra No	Bölge	Yetkili Servis	İsim	Telefon	Fax	Cep
01	KONYA	EMPERO A.Ş. / FABRİKA	FEVZİ SÖĞÜTLÜ	444 15 60	0332 239 12 11-10	0530 602 40 45
02	ADANA	KAREM END	MEHMET ÖZPAĞADA	0322 239 30 48	0322 239 30 58	0539 508 38 17
03	ADYAMAN	ORHAN TEKNİK SOĞUTMA	ORHAN BAĞIR	0416 214 32 81	0416 214 32 81	0535 270 73 87
04	AFYON	ALEV TİCARET	FATİH BEYTÜRK	0272 214 73 84	0272 214 73 84	0542 781 71 05
05	AKSARAY	ŞAHİN SOĞUTMA	TUNCAY KARATAY	0382 212 94 84	0382 212 10 30	0533 387 12 08
06	AMASYA	FATİH SOĞUTMA	FATİH ÇAYLAK	0358 212 07 77	0358 212 07 99	0549 212 07 77
07	ANKARA	İREM TEKNİK	RAŞİT ÇELEN	0312 341 00 39	0312 341 45 50	0535 676 55 99
08	ANKARA	PASİNOKS LTD.ŞTİ.	YAŞAR ÜNAL	031238710 33	0312 387 10 53	0533 232 8916
09	ANKARA	AYDIN SERVİS	MUSTAFA AYDIN	0312 319 05 00	0312 319 05 86	0532 432 68 38
10	ANKARA	YAĞIZ TEKNİK	H.BASRİ MIZRAK	0312 341 71 62	0312 341 71 62	0533 383 34 51
11	ANKARA	AK-SER GRUP END.	AZİZ KEÇECİ	0312 384 23 62	0312 284 23 63	0533 455 93 42
12	ANKARA	RASTEK	ŞÜKRÜ UGURLU	0312 480 32 36	0312 480 32 35	0507 204 08 60
13	ANTALYA	ALTEK END.	ALİ ATUNAY	0242 341 40 83	0242 340 01 54	0545 684 24 00
14	ANTALYA	NİKEL END.	FATİH ŞEN	0242 332 67 65	0242 331 19 52	0533 688 53 80
15	ANTALYA-KEPEZ	ZİRVE OTEL	METİN ALEVOK	0242 221 51 54	0242 221 51 54	0532 418 13 34
16	ANTALYA	GLOBAL END	UYGAR BATMAZ	0532 060 65 48		0532 060 65 48
17	ANTALYA -MANAVGAT	ÖZGÜR TEKNİK	ÖZGÜR TAYLAN	0242 743 27 19	0242 743 27 19	0535 528 82 59
18	ANTALYA-MANAVGAT	SEKTÖR MUTFAK	VELİ DOLU	0242 743 30 93	0242 746 75 66	0532 705 88 79
19	ANTALYA - ALANYA	ÇÖZÜM TEKNİK	MEHMET ŞENOL	0242 519 15 15	0242 511 81 66	0532 793 31 29
20	ANTALYA - ALANYA	ARDEMİR SOĞUTMA	KENAN DEMİR	0242 513 44 28	0242 513 44 39	0532 569 30 39
21	ANTALYA - ALANYA	KALE SOĞ	YAŞAR ÖZDEMİR	0242 522 03 22	0242 522 03 22	0532 564 09 92
22	AYDIN - NAZİLLİ	EFE SOĞUTMA	ALİ RIZA TERZİOĞLU	0256 312 38 18	0256 312 01 88	0535 216 38 06
23	AYDIN - KUŞADASI	GÖKOĞLU SOĞUTMA	BARAN GÖKOĞLU	0256 612 94 80	0256 612 94 80	0535 224 88 22
24	AĞRI	GÜVEN SOĞ.	ALİ KAHRAMAN	0472 215 11 59	0472 215 11 59	0544 292 48 13
25	BALIKESİR	NARLI TEKNİK	MEHMET ALİ DÜŞÜNEN	0266 239 08 89	0266 239 08 89	0536 524 96 29
26	BALIKESİR	ÖNDER TEKNİK	CİHAN ÖNDER	0266 241 20 11	0266 241 20 12	0532 706 62 45
27	BARTIN	İSOTEM	İHSAN MUTLU	0378 227 18 28	0378 227 18 28	0542 324 50 97
28	BATMAN	GLOBAL TİC.	MEHMET DURMAZ	0488 212 88 75	0488 214 16 39	0535 669 38 94
29	BATMAN	FURKAN TEKNİK	BEKİR AKTAŞ	0488 215 72 74	0488 215 72 74	0533 358 04 86
30	BİNGÖL	PINAR SOĞUTMA	MUHAMMET PINAR	0426 214 11 91	0426 214 11 91	0543 592 85 20
31	BİTLİS	CİNOĞLU SOĞUTMA	CEVDET CİNOĞLU	0434 226 64 73	0434 226 64 73	0537 685 76 92
32	BOLU	İKLİM SOĞUTMA	ERGÜN RÜZGAR	0374 212 23 32	0374 212 12 32	0532 635 05 52
33	BURSA	TEKNO-TEM	ALİ EKBER ÖZGÜNAL	0224 256 73 53	0224 256 73 55	0537 383 35 04
34	BURSA	TİPİ TEKNİK	ALPER KOCA	0224 361 04 39	0224 362 77 33	0532 792 34 84
35	ÇANAKKALE	SEVİNÇ TEKNİK	AYDIN SEVİNÇ	0286 217 36 99	0286 217 36 99	0542 838 88 98
36	ÇANKIRI	AKBIYIK TEKNİK	BURAK AKBIYIK	0376 213 42 56	0376 213 42 56	0542 313 50 87
37	ÇORUM	AKGÜL SOĞUTMA	CAFER AKGÜL	0364 224 40 44	0364 224 40 44	0532 275 08 79
38	ÇORUM	YILMAZ TÜRK ISITMA	FERDİ YILMAZTÜRK	0364 224 00 86	0364 213 75 50	0533 399 83 56
39	DENİZLİ	TUĞBA TİCARET	ASLAN BEY	0258 263 47 60	0258 263 47 60	0532 554 71 90
40	DENİZLİ	DEM DENİZLİ END	İSA AMAÇ	0258 565 66 00	0258 565 66 00	0532 387 55 63
41	DENİZLİ	CENGİZ SOĞUTMA	CENGİZ CEYLAN	0258 211 70 37	0258 212 43 35	0542 251 79 19
42	DIYARBAKIR	MALDİ GIDA	METİN ÖZTÜRK	0412-252-21-85	0412-251-31-98	0507 754 78 14
43	DIYARBAKIR	AS TEKNİK ISITMA SOĞ	AHMET MUMCU	0412 215 51 59	0412 215 51 59	0534 460 09 18
44	DIYARBAKIR	ÖZ SOĞUTMA	ORHAN ÖZCEYLAN	0412 238 00 13	0412 238 00 13	0532 548 34 71
45	EDİRNE - KEŞAN	BURSALI MAKİNE	HASAN BURSALI	0284 715 30 27	0284 715 30 27	0532 623 34 87
46	ELAZIĞ	NEKA TEKNİK	NECİP KAÇAR	0424 218 28 27	0424 218 28 27	0535 516 48 23
47	ELAZIĞ	AKADEMİ SOĞ.	ERKAN KUZU	0424 236 42 40	0424 236 42 40	0536 616 24 97
48	ERZİNCAN	METE DEMİREL (ARİSTON)	METE DEMİREL	0446 214 16 33	0446 223 83 85	0532 748 55 61
49	ERZURUM	DOĞU END.	SEFFAN YAŞAR	0507 836 07 56		0534 837 02 83
50	ERZURUM	KAFKAS TİCARET	SUAT MİDİLLİÇ	0442 213 39 59	0442 213 36 40	0442 234 11 12
51	ESKİŞEHİR	ELİT TEKNİK	ORHAN VURAL	0274 212 10 02	0274 212 10 02	0535 429 37 98
52	GAZİANTEP	YILDIZ SOĞUTMA	MUSTAFA SAKALLI	0342 325 37 00	0342 323 71 24	0535 443 21 98
53	GAZİANTEP	TEKNİK KİMYA	ALİ AKTOP	0342 323 24 35	0342 323 24 35	0533 934 68 10
54	GİRESUN	KADER SOĞUTMA	KADER TEKE	0454 216 19 23	0454 216 19 23	0536 841 14 79
55	HAKKARİ - YÜKSEKOVA	ÖZLEM SOĞUTMA	NİHAT GEÇİRGEN	0438 351 20 29	0438 351 82 06	0544 231 43 60
56	HATAY	ÇAĞ TEKNİK	HÜSEYİN BAYRAKTAR	0326 223 14 15	0326 223 14 15	0532 635 77 91
57	HATAY - İSKENDERUN	ARDON SOĞUTMA	HİDAYET KURTUL	0326 617 59 38	0326 613 08 25	0532 570 63 99
58	İĞDIR	GÜVEN TEKNİK	FEZULLAH GÜREL	0476 227 16 56	0476 227 16 56	0535 227 22 22
59	İSPARTA	KILINÇ SOĞUTMA	HALİL KILINÇ	0246 223 40 20	0246 223 86 71	0532 284 44 07
60	İSPARTA	MUTLU SOĞ	MUSTAN BÜLBÜL	0246 218 19 97	0246 218 19 97	0533 556 92 93
61	İSTANBUL- İÇERENKÖY	GÜVEN END.	KENAN TEYMUR	0216 577 00 67	0216 577 00 69	0536 844 73 94
62	İSTANBUL - ATAŞEHİR	EV-MAK	ZAFER ALADAĞ	0216 527 88 16	0216 540 10 09	0544 731 81 36
63	İSTANBUL - KASIMPAŞA	KARMA TEKNİK	DURAN KARATAY	0212 235 04 11	0212 361 71 87	0532 264 11 72
64	İSTANBUL - AVCILAR	ENG İNOKS	EMRE DERELİOĞLU	0212 695 42 46	0212 695 42 47	0537 577 65 01

Teknik Servis Listesi

S.Kodu	Bölge	Yetkili Servis	İsim	Telefon	Fax	Ce
S-064	İSTANBUL-KASIMPAŞA	SER-GAZ	RIFAT ALTINAY	0212 253 70 14	0212 250 12 04	0536 212
S-065	İSTANBUL - FATİH	İLES END.MUT.CİHAZ.	MURAT AKDAĞ	0212 635 09 66	0212 635 09 67	0533 499
S-066	İSTANBUL - KÜÇÜKÇEKMECE	ALFA TEKNİK	TURGAY YAVUZ	0212 678 70 01	0212 678 70 01	0532 523
S-067	İZMİR	ÖNCÜL SERVİS	HALİL ŞEN	0232 442 18 66	0232 440 00 68	0533 358
S-068	İZMİR	NİL TEKNİK	KADRI ŞENLİER	0236 366 21 31	0232 367 6353	0536 832
S-069	İZMİR	DELTA TEKNİK	SEDAT TALAY	0232 426 41 94	0232 426 41 94	0532 333
S-070	İZMİR	FROZEN TEKNİK	DAVUT KEKLİKSOY	0535 506 22 98		0535 506
S-071	İZMİR	SETEN MAK.	ERHAN GÖKOĞLU	0232 347 12 63	0232 462 81 67	0530 306
S-072	K.MARAŞ	KOZANOĞLU BOBİNAJ	MUSTAFA TEPEBAŞILI	0344 236 18 98	0344 236 18 98	0542 207
S-073	K.MARAŞ	KARDEŞLER END.	CAFER ÇİÇEK	0537 223 43 48		0537 223
S-074	K.MARAŞ	ÖZGÜR SOĞUTMA	ŞAHİN BÜYÜKMEHMET	0344 231 44 10	0344 231 02 35	0542 423
S-075	K.MARAŞ - ELBİSTAN	ZEDELİ SOĞUTMA	MEHMET ZEDELİ	0344 415 01 57	0344 415 38 73	0542 540
S-076	KARS	YAVUZ SOĞUTMA	ALİ YAVUZ	0474 223 80 39	0474 212 39 41	0533 339
S-077	KAYSERİ	KOÇLAR TİC.	YIMAZ KOÇLAR	0352 236 18 41	0352 236 18 53	0507 266
S-078	KARAMAN	ÖZ SOĞUTMA	MUSTAFA ÖZTÜRK	0338 212 06 74	0338 212 91 62	0543 530
S-079	KASTAMONU	KMS EV ALETLERİ	KENAN ALTAN	0366 214 26 96	0366 214 09 89	0543 288
S-080	KIRKLARELİ	MUTLU ISITMA SOĞ.	MUTLU KONAT	0288 214 67 66	0288 214 67 66	0542 526
S-081	KIRIKKALE	IŞIK SOĞ.	MUSTAFA IŞIK	0318 225 25 00	0318 225 25 00	0546 423
S-082	KIRŞEHİR	BARLAS SOĞ.	ŞEVKİ BARLAS	0386 212 31 56	0386 212 31 56	0532 623
S-083	KONYA	PEHLİVAN END.MUT	ALİ KARANFIL	0332 322 18 88	0332 322 18 81	0533 433
S-084	KONYA	ATLAS MAKİNE	YILMAZ KÜÇÜKELLİKİ	0332 322 07 07	0332 322 88 98	0532 476
S-085	KONYA - EREĞLİ	CAN BOBİNAJ	HÜSEYİN ÖZLÜ	0332 713 83 98	0332 713 83 98	0533 372
S-086	KÜTAHYA	ASİL TEK	KERİM KARACA	0274 216 19 73	0274 216 19 73	0537 973
S-087	KOCAELİ	İDEAL TEKNİK	YAVUZ DALKILINÇ	0264 274 29 75	0264 274 29 75	0532 266
S-088	MERSİN	BALKAN SOĞUTMA	BALKAN ÖLÇÜCÜ	0324 336 24 11	0324 336 24 11	0535 723
S-089	MERSİN	DEMİR TİC	DUR SUN DEMİR	0324 231 25 22	0324 231 25 22	0532 352
S-090	MERSİN- ANAMUR	ANAMUR SOĞUTMA	MUSTAFA YILMAZ	0324 814 34 88	0324 814 34 88	0536 279
S-091	MARDİN	MUM TEKNİK	CÜNEYT MUMCU	0482 213 32 82	0482 212 91 05	0532 392
S-092	MUŞ	BEYAZ SERVİS	CEVDET AKSOY	0436 212 29 96	0436 212 29 96	0542 833
S-093	MUŞ	GÜNAY SOGUTMA	KADİR GÜNAY	0436 212 26 89	0436 212 18 39	0541 784
S-094	MANİSA	AKSOY ELK.	FARUK AKSOY	0536 237 17 97		0507 784
S-095	MALATYA	ÖZ YILDIRIM SOĞUTMA	AHMET YILDIRIM	0422 324 04 63	0422 324 04 63	0533 320
S-096	MALATYA	BUZÇAM SERVİS	İZZET VAHAP ERGÖÇ	0422 321 51 06	0422 322 37 53	0532 499
S-097	MUĞLA - MARMARİS	ATA BOBİNAJ	YUSUF ÖNAL	0252 412 19 48	0252 412 19 48	0532 502
S-098	MUĞLA - MARMARİS	KAAN TEKNİK	AHMET BOSTANCI	0252 412 20 37	0252 412 20 38	0533 720
S-099	MUĞLA - MARMARİS	NURÇELİK END.	MEHMET BAL	0252-412 06 09	0252-412 06 09	0532 678
S-100	MUĞLA - BODRUM	CANAY TEKNİK	CEMİL RAMİTGAN	0252 313 64 47	0252 316 26 70	0532 274
S-101	MUĞLA - BODRUM	EMİR TEKNİK	ABDÜLMETİN TANSEL	0252 363 00 67	0252 363 00 67	0532 668
S-102	MUĞLA - FETHİYE	TEKNOSER	BAHRİ KİREZLİ	0252 612 50 62	0252 614 90 65	0532 688
S-103	MUĞLA - FETHİYE	BURAK TEKNİK	MUSA KAPLAN	0252 614 00 31	0252 614 00 31	0536 665
S-104	NEVŞEHİR	ALSTAR SOĞUTMA	CİHAT KOYUTÜRK	0384 214 17 26	0384 212 85 51	0532 436
S-105	NİĞDE	ARI SOĞUTMA	İSMAİL ARISOY	0388 213 32 78	0388 213 34 84	0536 488
S-106	ORDU	ÖZEN SOĞUTMA	MEHMET ÖZEN	0452 212 30 42	0452 212 30 42	0532 336
S-107	OSMANİYE	GÜRÜNLÜOĞLU	RAMAZAN KARAPINAR	0328 826 09 84	0328 826 09 84	0542 508
S-108	RİZE	TRİNOX	MEHMET KAYNAK	0464 213 33 25		0546 464
S-109	ŞİİRT	TANER SOĞUTMA	MEHMET TÜRKOĞLU	0484 224 61 41	0484 224 61 41	0544 224
S-110	SAKARYA - ADAPAZARI	MERKEZ TEKNİK	İSMAİL ÇEVİK	0264 282 00 33	0264 282 00 82	0530 242
S-111	SAMSUN	GÜLEÇ MAK.	MUSTAFA GÜLEÇ	0362 228 42 92	0362 228 42 92	0542 732
S-112	SİVAS	ADA PANEL	CELİL OKAN GÜRSESLİ	0346 225 19 20	0346 225 19 20	0544 863
S-113	ŞANLIURFA	ÇULLU TEKNİK	HASAN ÇULLU	0414 215 44 39	0414 215 15 09	0542 517
S-114	ŞIRNAK	KAR SOĞUTMA	FAİK UYSAL	0486 216 77 20	0486 216 77 20	0543 617
S-115	ŞIRNAK	GÜVEN TEKNİK	MEHMET KADRI	0486 216 74 29	0486 216 74 29	0542 423
S-116	TEKİRDAĞ - ÇORLU	ÖREN TEKNİK	HASAN ÖREN	0282 653 28 66	0282 651 73 82	0555 827
S-117	TOKAT	GÜNAY TEKNİK	DURAN AKTAŞ	0356 214 55 95	0356 214 55 95	0505 233
S-118	TRABZON	ATASOY MAKİNA	RECEP ATASOY	0462 341 52 69	0462 341 52 65	0555 643
S-119	TRABZON	M.S.R ENDÜSTRİYEL MUT.		0462 248 39 81	0462 248 39 81	
S-120	TUNCELİ	TURAN TEKNİK	İSMAİL TURAN	0428 212 35 47	0428 212 35 47	0532 499
S-121	UŞAK	KARAGÖZ SOĞUTMA	GÖKSEL KARAGÖZ	0276 224 46 35	0276 224 46 35	0536 230
S-122	VAN	ALPAY TEKNİK	ÖMER ALPAY	0432 215 77 17	0432 215 77 17	0539 313
S-123	YALOVA - ALTINOVA	DOĞAN TEKNİK	ORHAN DOĞAN	0226 461 23 41	0226 461 23 41	0555 346
S-124	YALOVA	YALOVA SOĞUTMA	RAMAZAN GÜLNAR	0226 814 67 04	0226 814 67 04	0532 307
S-125	YOZGAT - SORGUN	ÇAĞDAŞ ELEKTRİK	RAMAZAN TATAROĞLU	0354 415 83 92	0354 415 83 92	0535 426
S-126	K.K.T.C.- GAZİMAGOSA	MİRİNOKS MUTFAK	MUSTAFA ŞONYA	0392 366 42 11	0392 366 72 11	0533 840
S-126	K.K.T.C.- GİRNE	SABER END.MUTF.HİZ.	AHMET SEFER	0392 815 91 81	0392 815 91 82	0548 836



İLETİŞİM

Contact

EMPERO Endüstriyel Mutfak Ekipmanları Pazarlama İç ve Dış Tic. A.Ş.

Fabrika / Factory

Konya Organize Sanayi Bölgesi
Büyük Kayacık Mah. 9.Sokak No:20
42050 Selçuklu - KONYA / TÜRKİYE

Tel : 0090 444 15 60
Faks : 0090 332 239 12 10

Gsm : 0090 507 457 03 99
: 0090 533 658 94 54
: 0090 530 875 40 87

e-mail : empero@empero.com.tr

Showroom

Mahmut Şevket Paşa Mahallesi Şahinkaya Sk.
Azim Plaza No:13
34360 Şişli - İSTANBUL / TÜRKİYE

Tel : 0090 212 361 83 00 (pbx)
Faks : 0090 212 361 83 03
e-mail : istanbul@empero.com.tr

www.empero.com.tr

her zaman
yerde !
everytime in everywhere



G|R|O|U|P

İş'in Mutfağı / Kitchen of Business

www.empero.com.tr



Endüstriyel Mutfak Ekipmanları Pazarlama İç ve Dış Ticaret A.Ş.
Industrial Kitchen Equipment Marketing Import & Export Trade Co.